

**FA000S**

**LADA**



<b>OEM:</b>	
2101110910001	
2101110910002	
<b>EQUIVALÊNCIAS:</b>	
MANN	C2443
MAHLE	LX158
FRAM	CA660
WEGA	
TECFIL	AR2101
<b>MEDIDAS (mm):</b>	
COMPRIMENTO	
LARGURA	
ALTURA	62,2
D. INTERNO	182
D. EXTERNO	231
ROSCA	
BICOS	

**FA002S**

**MAHINDRA**



<b>OEM:</b>	
0313AC2261N	
1203CA1691N	
<b>EQUIVALÊNCIAS:</b>	
MANN	
MAHLE	
FRAM	JFAF20
WEGA	
TECFIL	
<b>MEDIDAS (mm):</b>	
COMPRIMENTO	351
LARGURA	196
ALTURA	60
D. INTERNO	
D. EXTERNO	
ROSCA	
BICOS	

**FA007S**

**CRYSLER**



<b>OEM:</b>	
04891176AA	
4891176AA	
<b>EQUIVALÊNCIAS:</b>	
MANN	C2681
MAHLE	LX1758
FRAM	CA8747
WEGA	FAP3282
TECFIL	
<b>MEDIDAS (mm):</b>	
COMPRIMENTO	254,7
LARGURA	189,3
ALTURA	37,8
D. INTERNO	
D. EXTERNO	
ROSCA	
BICOS	

**FA009S**

**CRYSLER**



<b>OEM:</b>	
5011836AA	
<b>EQUIVALÊNCIAS:</b>	
MANN	
MAHLE	
FRAM	CA9053
WEGA	JFA009
TECFIL	
<b>MEDIDAS (mm):</b>	
COMPRIMENTO	
LARGURA	
ALTURA	158,2
D. INTERNO	83
D. EXTERNO	127,3
ROSCA	
BICOS	

**FA010S**

**DODGE**



<b>OEM:</b>	
4573624	
4882141AB	
<b>EQUIVALÊNCIAS:</b>	
MANN	C2372
MAHLE	
FRAM	CA7432
WEGA	FAP2843
TECFIL	
<b>MEDIDAS (mm):</b>	
COMPRIMENTO	224
LARGURA	189
ALTURA	37
D. INTERNO	
D. EXTERNO	
ROSCA	
BICOS	

**FA012S**

**HUMMER**



<b>OEM:</b>	
15202408	
8152024080	
<b>EQUIVALÊNCIAS:</b>	
MANN	
MAHLE	LX1005
FRAM	CA10466
WEGA	JFA978
TECFIL	
<b>MEDIDAS (mm):</b>	
COMPRIMENTO	
LARGURA	
ALTURA	220
D. INTERNO	90
D. EXTERNO	148
ROSCA	
BICOS	

**FA013S**

**HUMMER**



<b>OEM:</b>	
15286805	
88944151	
<b>EQUIVALÊNCIAS:</b>	
MANN	MA1199
MAHLE	
FRAM	CA9900
WEGA	JFAHU0
TECFIL	
<b>MEDIDAS (mm):</b>	
COMPRIMENTO	284
LARGURA	157
ALTURA	183
D. INTERNO	
D. EXTERNO	
ROSCA	
BICOS	

**FA014S**

**JEEP**



<b>OEM:</b>	
4797777	
04797777	
<b>EQUIVALÊNCIAS:</b>	
MANN	
MAHLE	
FRAM	
WEGA	
TECFIL	
<b>MEDIDAS (mm):</b>	
COMPRIMENTO	346
LARGURA	160,8
ALTURA	32
D. INTERNO	
D. EXTERNO	
ROSCA	
BICOS	

**FA015S**

**CRYSLER**



<b>OEM:</b>	
4591100AC	
04591100AC	
<b>EQUIVALÊNCIAS:</b>	
MANN	C2376
MAHLE	
FRAM	CA8606
WEGA	FAP9021
TECFIL	
<b>MEDIDAS (mm):</b>	
COMPRIMENTO	242
LARGURA	179
ALTURA	39
D. INTERNO	
D. EXTERNO	
ROSCA	
BICOS	

**FA016S**

**VW / JEEP**



<b>OEM:</b>	
53006317	
53002184	
<b>EQUIVALÊNCIAS:</b>	
MANN	C3474
MAHLE	LX218
FRAM	CA3373
WEGA	FAP3202/FAP9022
TECFIL	
<b>MEDIDAS (mm):</b>	
COMPRIMENTO	332,2
LARGURA	132,5
ALTURA	41
D. INTERNO	
D. EXTERNO	
ROSCA	
BICOS	

**FA020S**

**DODGE / JEEP**



<b>OEM:</b>	
5189933AA 05189933AA	
<b>EQUIVALÊNCIAS:</b>	
MANN	C30198
MAHLE	
FRAM	CA10228
WEGA	JFA991
TECFIL	
<b>MEDIDAS (mm):</b>	
COMPRIMENTO	293
LARGURA	229
ALTURA	58
D. INTERNO	
D. EXTERNO	
ROSCA	
BICOS	

**FA021S**

**CADILLAC**



<b>OEM:</b>	
25798270 25728874	
<b>EQUIVALÊNCIAS:</b>	
MANN	
MAHLE	
FRAM	CA9459
WEGA	
TECFIL	
<b>MEDIDAS (mm):</b>	
COMPRIMENTO	319 / 274
LARGURA	244 / 267
ALTURA	32
D. INTERNO	
D. EXTERNO	
ROSCA	
BICOS	

**FA023S**

**CHERY**



<b>OEM:</b>	
A211109111	
<b>EQUIVALÊNCIAS:</b>	
MANN	
MAHLE	
FRAM	
WEGA	JFAF00
TECFIL	
<b>MEDIDAS (mm):</b>	
COMPRIMENTO	246
LARGURA	222
ALTURA	45
D. INTERNO	
D. EXTERNO	
ROSCA	
BICOS	

**FA024S**

**DODGE / FIAT**



<b>OEM:</b>	
4891916AA	
<b>EQUIVALÊNCIAS:</b>	
MANN	MA1028
MAHLE	LX3021
FRAM	CA10516
WEGA	JFA987
TECFIL	
<b>MEDIDAS (mm):</b>	
COMPRIMENTO	233
LARGURA	213
ALTURA	47
D. INTERNO	
D. EXTERNO	
ROSCA	
BICOS	

**FA025S**

**CHERY**



<b>OEM:</b>	
46806576	
<b>EQUIVALÊNCIAS:</b>	
MANN	C2498
MAHLE	LX1078
FRAM	CA9428
WEGA	
TECFIL	
<b>MEDIDAS (mm):</b>	
COMPRIMENTO	230
LARGURA	190
ALTURA	59
D. INTERNO	
D. EXTERNO	
ROSCA	
BICOS	

**FA026S**

**CHERY**



<b>OEM:</b>	
S211109111 5121109111N	
<b>EQUIVALÊNCIAS:</b>	
MANN	
MAHLE	
FRAM	
WEGA	JFAF01
TECFIL	
<b>MEDIDAS (mm):</b>	
COMPRIMENTO	208
LARGURA	195
ALTURA	40
D. INTERNO	
D. EXTERNO	
ROSCA	
BICOS	

**FA029S**

**CADILLAC**



<b>OEM:</b>	
25735595 25798271	
<b>EQUIVALÊNCIAS:</b>	
MANN	
MAHLE	
FRAM	CA9953
WEGA	
TECFIL	
<b>MEDIDAS (mm):</b>	
COMPRIMENTO	295
LARGURA	225
ALTURA	32
D. INTERNO	
D. EXTERNO	
ROSCA	
BICOS	

**FA101S**

**NISSAN**



<b>OEM:</b>	
16546S0100 1654623000	
<b>EQUIVALÊNCIAS:</b>	
MANN	C2868
MAHLE	LX1
FRAM	CA352
WEGA	JFA101
TECFIL	
<b>MEDIDAS (mm):</b>	
COMPRIMENTO	
LARGURA	
ALTURA	61
D. INTERNO	201
D. EXTERNO	257,2
ROSCA	
BICOS	

**FA108S**

**NISSAN**



<b>OEM:</b>	
16546V0100 165463J400	
<b>EQUIVALÊNCIAS:</b>	
MANN	C2964
MAHLE	LX307
FRAM	CA4309
WEGA	JFA108
TECFIL	
<b>MEDIDAS (mm):</b>	
COMPRIMENTO	279
LARGURA	165
ALTURA	33
D. INTERNO	
D. EXTERNO	
ROSCA	
BICOS	

**FA110S**

**NISSAN**



<b>OEM:</b>	
1654604N00 165460F000	
<b>EQUIVALÊNCIAS:</b>	
MANN	C13103/1
MAHLE	LX830
FRAM	CA5369
WEGA	JFA117
TECFIL	
<b>MEDIDAS (mm):</b>	
COMPRIMENTO	
LARGURA	
ALTURA	176,5
D. INTERNO	70,7 / 10
D. EXTERNO	127,3
ROSCA	
BICOS	



**FA126S**

**CHEVROLET / TROLLER**



<b>OEM:</b>	
16546D6200 0100706C16400	
<b>EQUIVALÊNCIAS:</b>	
MANN	C16400
MAHLE	LX1673
FRAM	CA9745
WEGA	WR200/5
TECFIL	ARS8842
<b>MEDIDAS (mm):</b>	
COMPRIMENTO	
LARGURA	
ALTURA	376,3
D. INTERNO	94,8
D. EXTERNO	155,2
ROSCA	
BICOS	

**FA129S**

**NISSAN**



<b>OEM:</b>	
16546EB300 YC159601BB	
<b>EQUIVALÊNCIAS:</b>	
MANN	C28145
MAHLE	LX1596
FRAM	CA8919
WEGA	JFA129
TECFIL	
<b>MEDIDAS (mm):</b>	
COMPRIMENTO	285,5
LARGURA	180
ALTURA	56
D. INTERNO	
D. EXTERNO	
ROSCA	
BICOS	

**FA133S**

**RENAULT**



<b>OEM:</b>	
7701044595 1654600QAC	
<b>EQUIVALÊNCIAS:</b>	
MANN	C32154/1
MAHLE	LX876
FRAM	CA8821
WEGA	FAP3271
TECFIL	ARL5137
<b>MEDIDAS (mm):</b>	
COMPRIMENTO	316
LARGURA	261
ALTURA	43
D. INTERNO	
D. EXTERNO	
ROSCA	
BICOS	

**FA134S**

**NISSAN**



<b>OEM:</b>	
16546ED000	
<b>EQUIVALÊNCIAS:</b>	
MANN	C2420
MAHLE	LX1631
FRAM	CA10234
WEGA	JFA134
TECFIL	ARL1654
<b>MEDIDAS (mm):</b>	
COMPRIMENTO	231
LARGURA	137
ALTURA	34
D. INTERNO	
D. EXTERNO	
ROSCA	
BICOS	

**FA135S**

**NISSAN**



<b>OEM:</b>	
16546JD20A 16456JG70A	
<b>EQUIVALÊNCIAS:</b>	
MANN	C2433/2
MAHLE	LX1983
FRAM	CA10654
WEGA	FAP9278
TECFIL	
<b>MEDIDAS (mm):</b>	
COMPRIMENTO	237
LARGURA	137 / 162
ALTURA	60
D. INTERNO	
D. EXTERNO	
ROSCA	
BICOS	

**FA138S**

**NISSAN**



<b>OEM:</b>	
1654600QAM 1654600Q0G	
<b>EQUIVALÊNCIAS:</b>	
MANN	C36172
MAHLE	LX1794
FRAM	
WEGA	
TECFIL	
<b>MEDIDAS (mm):</b>	
COMPRIMENTO	356
LARGURA	262
ALTURA	47
D. INTERNO	
D. EXTERNO	
ROSCA	
BICOS	

**FA140S**

**NISSAN**



<b>OEM:</b>	
16546EB70A	
<b>EQUIVALÊNCIAS:</b>	
MANN	
MAHLE	
FRAM	
WEGA	JFA118
TECFIL	
<b>MEDIDAS (mm):</b>	
COMPRIMENTO	256
LARGURA	196
ALTURA	46
D. INTERNO	
D. EXTERNO	
ROSCA	
BICOS	

**FA142S**

**NISSAN**



<b>OEM:</b>	
165461HC2A	
<b>EQUIVALÊNCIAS:</b>	
MANN	C2329
MAHLE	LX3305
FRAM	CA5619
WEGA	JFA198
TECFIL	
<b>MEDIDAS (mm):</b>	
COMPRIMENTO	228
LARGURA	168
ALTURA	34
D. INTERNO	
D. EXTERNO	
ROSCA	
BICOS	

**FA144S**

**INFINITY / NISSAN**



<b>OEM:</b>	
16546JK20A	
<b>EQUIVALÊNCIAS:</b>	
MANN	
MAHLE	
FRAM	CA10544
WEGA	JFA109
TECFIL	
<b>MEDIDAS (mm):</b>	
COMPRIMENTO	180
LARGURA	167
ALTURA	32
D. INTERNO	
D. EXTERNO	
ROSCA	
BICOS	

**FA145S**

**NISSAN**



<b>OEM:</b>	
8200795348 1654600Q1L	
<b>EQUIVALÊNCIAS:</b>	
MANN	C30011
MAHLE	LX1883
FRAM	CA11073
WEGA	
TECFIL	
<b>MEDIDAS (mm):</b>	
COMPRIMENTO	293
LARGURA	202
ALTURA	80
D. INTERNO	
D. EXTERNO	
ROSCA	
BICOS	

**FA190S**



**OEM:**  
165462S600  
165462S602

**EQUIVALÊNCIAS:**

MANN	
MAHLE	LX2000
FRAM	
WEGA	JFA101/1
TECFIL	

**MEDIDAS (mm):**

COMPRIMENTO	
LARGURA	
ALTURA	187,5
D. INTERNO	74
D. EXTERNO	148
ROSCA	
BICOS	

**FA192S**



**OEM:**  
165463S903  
16546J5570

**EQUIVALÊNCIAS:**

MANN	
MAHLE	
FRAM	
WEGA	JFA101/2
TECFIL	

**MEDIDAS (mm):**

COMPRIMENTO	
LARGURA	
ALTURA	241,5
D. INTERNO	87,5 / 17,2
D. EXTERNO	154
ROSCA	
BICOS	

**FA194S**



**OEM:**  
165467F002  
165467F000

**EQUIVALÊNCIAS:**

MANN	C14176
MAHLE	LX803
FRAM	CA5930
WEGA	JFA194
TECFIL	

**MEDIDAS (mm):**

COMPRIMENTO	
LARGURA	
ALTURA	231
D. INTERNO	78
D. EXTERNO	138
ROSCA	
BICOS	

**FA196S**



**OEM:**  
17220PEFM01  
17220P2A005

**EQUIVALÊNCIAS:**

MANN	C2329
MAHLE	LX1298
FRAM	CA8040
WEGA	FAP2408
TECFIL	ARL1030

**MEDIDAS (mm):**

COMPRIMENTO	229,5
LARGURA	169,8
ALTURA	34,5
D. INTERNO	
D. EXTERNO	
ROSCA	
BICOS	

**FA224S**



**OEM:**  
1780187104  
1780145020

**EQUIVALÊNCIAS:**

MANN	C2368
MAHLE	LX570
FRAM	CA4778
WEGA	JFA609
TECFIL	

**MEDIDAS (mm):**

COMPRIMENTO	221
LARGURA	164,5
ALTURA	51
D. INTERNO	
D. EXTERNO	
ROSCA	
BICOS	

**FA233S**



**OEM:**  
1780170020  
1780141090

**EQUIVALÊNCIAS:**

MANN	C2262
MAHLE	LX837
FRAM	CA4939
WEGA	JFA233
TECFIL	

**MEDIDAS (mm):**

COMPRIMENTO	
LARGURA	
ALTURA	68,3
D. INTERNO	
D. EXTERNO	219
ROSCA	
BICOS	

**FA234S**



**OEM:**  
1780154060  
1780141110

**EQUIVALÊNCIAS:**

MANN	C20189
MAHLE	LX606
FRAM	CA3688
WEGA	JFA234
TECFIL	

**MEDIDAS (mm):**

COMPRIMENTO	
LARGURA	
ALTURA	141,5
D. INTERNO	108,6
D. EXTERNO	185
ROSCA	
BICOS	

**FA238S**



**OEM:**  
1780102020  
1780116030

**EQUIVALÊNCIAS:**

MANN	C31101/1
MAHLE	LX809
FRAM	CA6395
WEGA	JFA238
TECFIL	

**MEDIDAS (mm):**

COMPRIMENTO	310
LARGURA	155
ALTURA	42
D. INTERNO	
D. EXTERNO	
ROSCA	
BICOS	

**FA239S**



**OEM:**  
1780116010  
1780116020

**EQUIVALÊNCIAS:**

MANN	C2568
MAHLE	LX807
FRAM	CA5125
WEGA	JFA239
TECFIL	

**MEDIDAS (mm):**

COMPRIMENTO	247
LARGURA	153,5
ALTURA	41
D. INTERNO	
D. EXTERNO	
ROSCA	
BICOS	

**FA240S**



**OEM:**  
1780115060  
178011506083

**EQUIVALÊNCIAS:**

MANN	C2619
MAHLE	LX733
FRAM	CA6544
WEGA	JFA237
TECFIL	

**MEDIDAS (mm):**

COMPRIMENTO	
LARGURA	
ALTURA	33,5
D. INTERNO	20,8
D. EXTERNO	255
ROSCA	
BICOS	



**FA246S**



**OEM:**  
1780154080  
1780154120

**EQUIVALÊNCIAS:**

MANN	C16136
MAHLE	LX912
FRAM	CA4255
WEGA	JFA227/1
TECFIL	AP1008

**MEDIDAS (mm):**

COMPRIMENTO	
LARGURA	
ALTURA	204
D. INTERNO	86 / 14
D. EXTERNO	150
ROSCA	
BICOS	

MITSUBISHI / TOYOTA

**FA247S**



**OEM:**  
1780150010

**EQUIVALÊNCIAS:**

MANN	
MAHLE	
FRAM	CA6821
WEGA	JFA247
TECFIL	

**MEDIDAS (mm):**

COMPRIMENTO	
LARGURA	
ALTURA	60,5
D. INTERNO	
D. EXTERNO	256,5
ROSCA	
BICOS	

LEXUS

**FA249S**



**OEM:**  
1780115070  
1780102030

**EQUIVALÊNCIAS:**

MANN	C2731/1
MAHLE	LX811
FRAM	CA5466
WEGA	JFA249
TECFIL	ARL5070

**MEDIDAS (mm):**

COMPRIMENTO	266,3
LARGURA	171,6
ALTURA	42,3
D. INTERNO	
D. EXTERNO	
ROSCA	
BICOS	

TOYOTA / CHERY

**FA251S**



**OEM:**  
1780130040  
1780130080

**EQUIVALÊNCIAS:**

MANN	C32005
MAHLE	LX1700
FRAM	CA8918
WEGA	JFA251
TECFIL	

**MEDIDAS (mm):**

COMPRIMENTO	313
LARGURA	231
ALTURA	52
D. INTERNO	
D. EXTERNO	
ROSCA	
BICOS	

TOYOTA

**FA252S**



**OEM:**  
1780120040  
178010H020

**EQUIVALÊNCIAS:**

MANN	C2341
MAHLE	LX1612
FRAM	CA9360
WEGA	JFA252
TECFIL	

**MEDIDAS (mm):**

COMPRIMENTO	317,5
LARGURA	193,2
ALTURA	45,5
D. INTERNO	
D. EXTERNO	
ROSCA	
BICOS	

LEXUS / TOYOTA

**FA257S**



**OEM:**  
17801AD010  
1780131120

**EQUIVALÊNCIAS:**

MANN	C26003
MAHLE	LX2681
FRAM	CA10169
WEGA	JFA257
TECFIL	

**MEDIDAS (mm):**

COMPRIMENTO	255
LARGURA	140 / 237
ALTURA	60
D. INTERNO	
D. EXTERNO	
ROSCA	
BICOS	

LEXUS / TOYOTA

**FA259S**



**OEM:**  
178010C010  
WE0113Z40

**EQUIVALÊNCIAS:**

MANN	C23107
MAHLE	LX2125
FRAM	CA10112
WEGA	JFA292/2
TECFIL	ARS7065

**MEDIDAS (mm):**

COMPRIMENTO	
LARGURA	
ALTURA	172
D. INTERNO	120
D. EXTERNO	220
ROSCA	
BICOS	

TOYOTA

**FA260S**



**OEM:**  
1780131110

**EQUIVALÊNCIAS:**

MANN	
MAHLE	
FRAM	CA10347
WEGA	
TECFIL	

**MEDIDAS (mm):**

COMPRIMENTO	145 / 240
LARGURA	178 / 237
ALTURA	52
D. INTERNO	
D. EXTERNO	
ROSCA	
BICOS	

LEXUS

**FA261S**



**OEM:**  
178010D060  
1780121050

**EQUIVALÊNCIAS:**

MANN	C24005
MAHLE	
FRAM	CA10190
WEGA	JFA285
TECFIL	ARL2203

**MEDIDAS (mm):**

COMPRIMENTO	242
LARGURA	176
ALTURA	50
D. INTERNO	
D. EXTERNO	
ROSCA	
BICOS	

TOYOTA

**FA263S**



**OEM:**  
1780138030  
1780105010

**EQUIVALÊNCIAS:**

MANN	
MAHLE	LX2750
FRAM	CA10343
WEGA	
TECFIL	

**MEDIDAS (mm):**

COMPRIMENTO	315
LARGURA	296
ALTURA	52
D. INTERNO	
D. EXTERNO	
ROSCA	
BICOS	

TOYOTA

**LEXUS**

**FA265S**



<b>OEM:</b>	
1780120050	
<b>EQUIVALÊNCIAS:</b>	
MANN	LX2634
MAHLE	CA10257
FRAM	
WEGA	
TECFIL	
<b>MEDIDAS (mm):</b>	
COMPRIMENTO	366
LARGURA	157
ALTURA	49
D. INTERNO	
D. EXTERNO	
ROSCA	
BICOS	

**TOYOTA**

**FA266S**



<b>OEM:</b>	
1780131090 178010P010	
<b>EQUIVALÊNCIAS:</b>	
MANN	MA1140
MAHLE	CA9683
FRAM	JFA253
WEGA	
TECFIL	
<b>MEDIDAS (mm):</b>	
COMPRIMENTO	356
LARGURA	166 / 109
ALTURA	62
D. INTERNO	
D. EXTERNO	
ROSCA	
BICOS	

**TOYOTA**

**FA270S**



<b>OEM:</b>	
1780167050	
<b>EQUIVALÊNCIAS:</b>	
MANN	LX873
MAHLE	
FRAM	
WEGA	
TECFIL	
<b>MEDIDAS (mm):</b>	
COMPRIMENTO	
LARGURA	
ALTURA	150,6
D. INTERNO	120
D. EXTERNO	199
ROSCA	
BICOS	

**LEXUS**

**FA272S**



<b>OEM:</b>	
1780150040 1780107010	
<b>EQUIVALÊNCIAS:</b>	
MANN	
MAHLE	
FRAM	CA8918
WEGA	
TECFIL	
<b>MEDIDAS (mm):</b>	
COMPRIMENTO	308
LARGURA	231
ALTURA	50
D. INTERNO	
D. EXTERNO	
ROSCA	
BICOS	

**TOYOTA**

**FA273S**



<b>OEM:</b>	
1780175030 1780162010	
<b>EQUIVALÊNCIAS:</b>	
MANN	LX2028
MAHLE	
FRAM	
WEGA	
TECFIL	
<b>MEDIDAS (mm):</b>	
COMPRIMENTO	
LARGURA	
ALTURA	146
D. INTERNO	86
D. EXTERNO	197,2
ROSCA	
BICOS	

**TOYOTA**

**FA276S**



<b>OEM:</b>	
1780170050	
<b>EQUIVALÊNCIAS:</b>	
MANN	C3318
MAHLE	LX1936
FRAM	CA9826
WEGA	JFA276
TECFIL	
<b>MEDIDAS (mm):</b>	
COMPRIMENTO	120,8 / 333
LARGURA	70 / 125
ALTURA	52,3
D. INTERNO	
D. EXTERNO	
ROSCA	
BICOS	

**LEXUS**

**FA280S**



<b>OEM:</b>	
1780146080	
<b>EQUIVALÊNCIAS:</b>	
MANN	LX2873
MAHLE	CA10463
FRAM	JFA280
WEGA	
TECFIL	
<b>MEDIDAS (mm):</b>	
COMPRIMENTO	240
LARGURA	210
ALTURA	52
D. INTERNO	
D. EXTERNO	
ROSCA	
BICOS	

**LEXUS**

**FA281S**



<b>OEM:</b>	
1780150030	
<b>EQUIVALÊNCIAS:</b>	
MANN	
MAHLE	
FRAM	CA8612
WEGA	JFA281
TECFIL	
<b>MEDIDAS (mm):</b>	
COMPRIMENTO	252
LARGURA	218,3
ALTURA	53,5
D. INTERNO	
D. EXTERNO	
ROSCA	
BICOS	

**TOYOTA**

**FA282S**



<b>OEM:</b>	
1780154150 177005B091	
<b>EQUIVALÊNCIAS:</b>	
MANN	C22013
MAHLE	LX1641
FRAM	CA9120
WEGA	
TECFIL	
<b>MEDIDAS (mm):</b>	
COMPRIMENTO	
LARGURA	
ALTURA	119,7
D. INTERNO	108,3
D. EXTERNO	219,4
ROSCA	
BICOS	

**LIFAN / TOYOTA**

**FA283S**



<b>OEM:</b>	
1780122020 178010D010	
<b>EQUIVALÊNCIAS:</b>	
MANN	C2620
MAHLE	LX1286
FRAM	CA9482
WEGA	JFA283
TECFIL	ARL2202
<b>MEDIDAS (mm):</b>	
COMPRIMENTO	290
LARGURA	150
ALTURA	48
D. INTERNO	
D. EXTERNO	
ROSCA	
BICOS	



TOYOTA	<b>FA284S</b>	<b>OEM:</b> 1780128010
		<b>EQUIVALÊNCIAS:</b>
		MANN C3725 MAHLE LX1611 FRAM CA9359 WEGA JFA284 TECFIL
		<b>MEDIDAS (mm):</b>
		COMPRIMENTO 214 / 378,5 LARGURA 114 / 139,5 ALTURA 46 D. INTERNO D. EXTERNO ROSCA BICOS



TOYOTA	<b>FA287S</b>	<b>OEM:</b> 1780154160 1780154180
		<b>EQUIVALÊNCIAS:</b>
		MANN MAHLE LX1139 FRAM WEGA TECFIL
		<b>MEDIDAS (mm):</b>
		COMPRIMENTO LARGURA ALTURA 121 D. INTERNO 109 D. EXTERNO 217,5 ROSCA BICOS



TOYOTA	<b>FA290S</b>	<b>OEM:</b> 1780148012 1780158010
		<b>EQUIVALÊNCIAS:</b>
		MANN C20131 MAHLE FRAM CA5122 WEGA JFA290 TECFIL
		<b>MEDIDAS (mm):</b>
		COMPRIMENTO LARGURA ALTURA 145 D. INTERNO 87,6 D. EXTERNO 190 ROSCA BICOS



TOYOTA	<b>FA292S</b>	<b>OEM:</b> 1780167060 1780130030
		<b>EQUIVALÊNCIAS:</b>
		MANN C22267 MAHLE LX1140 FRAM CA376 WEGA JFA292 TECFIL AP7060
		<b>MEDIDAS (mm):</b>
		COMPRIMENTO LARGURA ALTURA 145 D. INTERNO 109 D. EXTERNO 219,5 ROSCA BICOS



TOYOTA	<b>FA292/1S</b>	<b>OEM:</b> 1780167070
		<b>EQUIVALÊNCIAS:</b>
		MANN C24203 MAHLE LX2530 FRAM CA9916 WEGA JFA292/1 TECFIL AP7070
		<b>MEDIDAS (mm):</b>
		COMPRIMENTO LARGURA ALTURA 121 D. INTERNO 112 D. EXTERNO 237 ROSCA BICOS



LEXUS / TOYOTA	<b>FA293S</b>	<b>OEM:</b> 1780146060 1780107020
		<b>EQUIVALÊNCIAS:</b>
		MANN MAHLE LX866 FRAM WEGA JFA293 TECFIL
		<b>MEDIDAS (mm):</b>
		COMPRIMENTO 244,5 LARGURA 206 ALTURA 51,6 D. INTERNO D. EXTERNO ROSCA BICOS



LEXUS	<b>FA294S</b>	<b>OEM:</b> 1780151083 1780150060
		<b>EQUIVALÊNCIAS:</b>
		MANN MAHLE LX1613 FRAM WEGA JFA294 TECFIL
		<b>MEDIDAS (mm):</b>
		COMPRIMENTO 283 / 138 LARGURA 231,3 / 140 ALTURA 58,6 D. INTERNO D. EXTERNO ROSCA BICOS



LEXUS	<b>FA295S</b>	<b>OEM:</b> 1780150020 1780154130
		<b>EQUIVALÊNCIAS:</b>
		MANN MAHLE FRAM CA8094 WEGA JFA295 TECFIL
		<b>MEDIDAS (mm):</b>
		COMPRIMENTO 275 LARGURA 209 ALTURA 51 D. INTERNO D. EXTERNO ROSCA BICOS



TOYOTA	<b>FA296S</b>	<b>OEM:</b> 178010B010 178010B020
		<b>EQUIVALÊNCIAS:</b>
		MANN C32140/1 MAHLE LX979 FRAM CA5467 WEGA FAP3604 TECFIL
		<b>MEDIDAS (mm):</b>
		COMPRIMENTO 312 LARGURA 150 ALTURA 67 D. INTERNO D. EXTERNO ROSCA BICOS



TOYOTA	<b>FA297S</b>	<b>OEM:</b> 1780111080
		<b>EQUIVALÊNCIAS:</b>
		MANN C2524 MAHLE LX923 FRAM CA7167 WEGA JFA297 TECFIL
		<b>MEDIDAS (mm):</b>
		COMPRIMENTO 249 LARGURA 122 ALTURA 52 D. INTERNO D. EXTERNO ROSCA BICOS



**LEXUS / TOYOTA**

**FA298S**



<b>OEM:</b>	
1780174060	
1780103010	
<b>EQUIVALÊNCIAS:</b>	
MANN	C31126
MAHLE	LX8140
FRAM	CA7351
WEGA	JFA298
TECFIL	
<b>MEDIDAS (mm):</b>	
COMPRIMENTO	308
LARGURA	185,5
ALTURA	41
D. INTERNO	
D. EXTERNO	
ROSCA	
BICOS	

**TOYOTA**

**FA299S**



<b>OEM:</b>	
1500A286	
1780135020	
<b>EQUIVALÊNCIAS:</b>	
MANN	C2535
MAHLE	LX812
FRAM	CA6690
WEGA	JFA299
TECFIL	
<b>MEDIDAS (mm):</b>	
COMPRIMENTO	250
LARGURA	170
ALTURA	51,5
D. INTERNO	
D. EXTERNO	
ROSCA	
BICOS	

**MAZDA**

**FA307S**



<b>OEM:</b>	
HE 1923603	
HE 19236039A	
<b>EQUIVALÊNCIAS:</b>	
MANN	C2562
MAHLE	LX336
FRAM	CA6690
WEGA	FAP3221
TECFIL	
<b>MEDIDAS (mm):</b>	
COMPRIMENTO	250
LARGURA	169
ALTURA	43,5
D. INTERNO	
D. EXTERNO	
ROSCA	
BICOS	

**MAZDA**

**FA310S**



<b>OEM:</b>	
RF0113Z409A	
RF0123Z40	
<b>EQUIVALÊNCIAS:</b>	
MANN	C21146
MAHLE	LX639
FRAM	CA5284
WEGA	
TECFIL	
<b>MEDIDAS (mm):</b>	
COMPRIMENTO	
LARGURA	
ALTURA	97
D. INTERNO	126 / 9,5
D. EXTERNO	201,5
ROSCA	
BICOS	

**MAZDA**

**FA312S**



<b>OEM:</b>	
E5D323603	
E5D3236039A	
<b>EQUIVALÊNCIAS:</b>	
MANN	C2477
MAHLE	LX320
FRAM	
WEGA	FAP4022
TECFIL	
<b>MEDIDAS (mm):</b>	
COMPRIMENTO	230
LARGURA	196
ALTURA	46,7
D. INTERNO	
D. EXTERNO	
ROSCA	
BICOS	

**MAZDA**

**FA313S**



<b>OEM:</b>	
R20523603	
R20913Z40	
<b>EQUIVALÊNCIAS:</b>	
MANN	C16122
MAHLE	
FRAM	CA4965
WEGA	JFA313
TECFIL	
<b>MEDIDAS (mm):</b>	
COMPRIMENTO	
LARGURA	
ALTURA	159
D. INTERNO	76
D. EXTERNO	155
ROSCA	
BICOS	

**MAZDA**

**FA317S**



<b>OEM:</b>	
JE1513Z40	
JF0113Z40	
<b>EQUIVALÊNCIAS:</b>	
MANN	C2483
MAHLE	LX679
FRAM	CA6558
WEGA	JFA317
TECFIL	
<b>MEDIDAS (mm):</b>	
COMPRIMENTO	235,8
LARGURA	200,8
ALTURA	40
D. INTERNO	
D. EXTERNO	
ROSCA	
BICOS	

**MAZDA**

**FA321S**



<b>OEM:</b>	
AS0113Z40	
F20113Z40	
<b>EQUIVALÊNCIAS:</b>	
MANN	C2573
MAHLE	
FRAM	
WEGA	
TECFIL	
<b>MEDIDAS (mm):</b>	
COMPRIMENTO	255
LARGURA	177
ALTURA	38
D. INTERNO	
D. EXTERNO	
ROSCA	
BICOS	

**MAZDA**

**FA323S**



<b>OEM:</b>	
B6S713Z40	
<b>EQUIVALÊNCIAS:</b>	
MANN	C2552/2
MAHLE	LX350
FRAM	CA6828
WEGA	JFA323
TECFIL	
<b>MEDIDAS (mm):</b>	
COMPRIMENTO	250
LARGURA	153
ALTURA	38
D. INTERNO	
D. EXTERNO	
ROSCA	
BICOS	

**FORD / MAZDA**

**FA327S**



<b>OEM:</b>	
FS0513Z40	
<b>EQUIVALÊNCIAS:</b>	
MANN	C2666
MAHLE	LX542
FRAM	CA5445
WEGA	JFA327
TECFIL	
<b>MEDIDAS (mm):</b>	
COMPRIMENTO	255,3
LARGURA	166
ALTURA	38
D. INTERNO	
D. EXTERNO	
ROSCA	
BICOS	



**MAZDA**

**FA330S**



<b>OEM:</b>	
K80113Z40 K80113Z40A	
<b>EQUIVALÊNCIAS:</b>	
MANN	LX546
MAHLE	CA7368
FRAM	CA7368
WEGA	JFA330
TECFIL	
<b>MEDIDAS (mm):</b>	
COMPRIMENTO	270
LARGURA	185/145
ALTURA	40
D. INTERNO	
D. EXTERNO	
ROSCA	
BICOS	

**DODGE / MAZDA**

**FA334S**



<b>OEM:</b>	
N3H113Z40	
<b>EQUIVALÊNCIAS:</b>	
MANN	CA9912
MAHLE	LX2001
FRAM	
WEGA	JFA320
TECFIL	
<b>MEDIDAS (mm):</b>	
COMPRIMENTO	375
LARGURA	228
ALTURA	49
D. INTERNO	
D. EXTERNO	
ROSCA	
BICOS	

**MINI COOPER**

**FA350S**



<b>OEM:</b>	
13721477840	
<b>EQUIVALÊNCIAS:</b>	
MANN	C2237
MAHLE	
FRAM	CA9494
WEGA	FAP2413
TECFIL	
<b>MEDIDAS (mm):</b>	
COMPRIMENTO	216
LARGURA	168
ALTURA	30
D. INTERNO	
D. EXTERNO	
ROSCA	
BICOS	

**MAZDA / MITSUBISHI**

**FA383S**



<b>OEM:</b>	
MR266849 MR323075	
<b>EQUIVALÊNCIAS:</b>	
MANN	C25128
MAHLE	LX929
FRAM	CA9021
WEGA	JFA574
TECFIL	
<b>MEDIDAS (mm):</b>	
COMPRIMENTO	249
LARGURA	200
ALTURA	53
D. INTERNO	
D. EXTERNO	
ROSCA	
BICOS	

**DAEWOO**

**FA385S**



<b>OEM:</b>	
96182220	
<b>EQUIVALÊNCIAS:</b>	
MANN	C2229
MAHLE	LX827
FRAM	CA8729
WEGA	JFA385
TECFIL	
<b>MEDIDAS (mm):</b>	
COMPRIMENTO	209
LARGURA	202
ALTURA	39,5
D. INTERNO	
D. EXTERNO	
ROSCA	
BICOS	

**DAEWOO**

**FA387S**



<b>OEM:</b>	
96181263	
<b>EQUIVALÊNCIAS:</b>	
MANN	C2537/1
MAHLE	LX829
FRAM	CA8730
WEGA	JFA387
TECFIL	
<b>MEDIDAS (mm):</b>	
COMPRIMENTO	247,7
LARGURA	204
ALTURA	39,5
D. INTERNO	
D. EXTERNO	
ROSCA	
BICOS	

**KIA**

**FA388S**

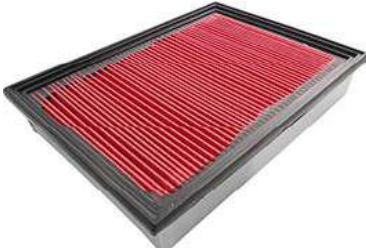

<b>OEM:</b>	
0K01713Z40B 0K02413Z40	
<b>EQUIVALÊNCIAS:</b>	
MANN	C28162
MAHLE	LX1821
FRAM	CA5873
WEGA	JFA388
TECFIL	ARL1713
<b>MEDIDAS (mm):</b>	
COMPRIMENTO	274
LARGURA	202
ALTURA	59
D. INTERNO	
D. EXTERNO	
ROSCA	
BICOS	

**MAZDA**

**FA392S**



<b>OEM:</b>	
WL3113Z40 WL63113Z40	
<b>EQUIVALÊNCIAS:</b>	
MANN	
MAHLE	
FRAM	CA5785
WEGA	JFA392
TECFIL	
<b>MEDIDAS (mm):</b>	
COMPRIMENTO	
LARGURA	
ALTURA	179
D. INTERNO	88
D. EXTERNO	155
ROSCA	
BICOS	

**DAEWOO**

**FA394S**



<b>OEM:</b>	
92060868 1579565	
<b>EQUIVALÊNCIAS:</b>	
MANN	C2598
MAHLE	LX316
FRAM	CA5371
WEGA	FAP3259
TECFIL	ARL1118
<b>MEDIDAS (mm):</b>	
COMPRIMENTO	248
LARGURA	212
ALTURA	40
D. INTERNO	
D. EXTERNO	
ROSCA	
BICOS	

**KIA**

**FA395S**



<b>OEM:</b>	
0K01113Z40 0K01113Z40	
<b>EQUIVALÊNCIAS:</b>	
MANN	C2733
MAHLE	LX677
FRAM	CA8121
WEGA	JFA395
TECFIL	
<b>MEDIDAS (mm):</b>	
COMPRIMENTO	264
LARGURA	183
ALTURA	37
D. INTERNO	
D. EXTERNO	
ROSCA	
BICOS	

**MAZDA**

**FA397S**



<b>OEM:</b>	
B59513Z40	
B59513Z409A	
<b>EQUIVALÊNCIAS:</b>	
MANN	C2564
MAHLE	LX534
FRAM	CA5595
WEGA	FAP3255
TECFIL	
<b>MEDIDAS (mm):</b>	
COMPRIMENTO	241
LARGURA	159
ALTURA	37,5
D. INTERNO	
D. EXTERNO	
ROSCA	
BICOS	

**KIA**

**FA398S**



<b>OEM:</b>	
0K20113Z00	
0K24713240	
<b>EQUIVALÊNCIAS:</b>	
MANN	C2656
MAHLE	LX676
FRAM	CA7669
WEGA	JFA398
TECFIL	
<b>MEDIDAS (mm):</b>	
COMPRIMENTO	256
LARGURA	158
ALTURA	41
D. INTERNO	
D. EXTERNO	
ROSCA	
BICOS	

**HONDA**

**FA400S**



<b>OEM:</b>	
17220RZPG00	
17220RZAA00	
<b>EQUIVALÊNCIAS:</b>	
MANN	
MAHLE	LX3007
FRAM	CA10911
WEGA	JFA433
TECFIL	
<b>MEDIDAS (mm):</b>	
COMPRIMENTO	262
LARGURA	173
ALTURA	40
D. INTERNO	
D. EXTERNO	
ROSCA	
BICOS	

**HONDA**

**FA420S**



<b>OEM:</b>	
17220PK2003	
17220PK2661	
<b>EQUIVALÊNCIAS:</b>	
MANN	
MAHLE	LX879
FRAM	
WEGA	JFA420
TECFIL	
<b>MEDIDAS (mm):</b>	
COMPRIMENTO	
LARGURA	
ALTURA	186,5
D. INTERNO	71,5
D. EXTERNO	134,5
ROSCA	
BICOS	

**HONDA**

**FA422S**



<b>OEM:</b>	
17220PT2000	
17220PY2000	
<b>EQUIVALÊNCIAS:</b>	
MANN	C2537/2
MAHLE	LX350
FRAM	CA6807
WEGA	JFA422
TECFIL	
<b>MEDIDAS (mm):</b>	
COMPRIMENTO	242,2
LARGURA	138
ALTURA	40
D. INTERNO	
D. EXTERNO	
ROSCA	
BICOS	

**HONDA**

**FA423S**



<b>OEM:</b>	
17220PW0000	
17220PW0010	
<b>EQUIVALÊNCIAS:</b>	
MANN	
MAHLE	LX850
FRAM	
WEGA	JFA436
TECFIL	
<b>MEDIDAS (mm):</b>	
COMPRIMENTO	234,3/187,5
LARGURA	157/123
ALTURA	36
D. INTERNO	
D. EXTERNO	
ROSCA	
BICOS	

**HONDA**

**FA424S**



<b>OEM:</b>	
17220PAAA00	
17220PDAAE01	
<b>EQUIVALÊNCIAS:</b>	
MANN	C2825/1
MAHLE	LX1075
FRAM	CA8133
WEGA	JFA495/1
TECFIL	
<b>MEDIDAS (mm):</b>	
COMPRIMENTO	272
LARGURA	168,2
ALTURA	41
D. INTERNO	
D. EXTERNO	
ROSCA	
BICOS	

**HONDA**

**FA425S**



<b>OEM:</b>	
17220P8CA00	
17244P8CA00	
<b>EQUIVALÊNCIAS:</b>	
MANN	C3234
MAHLE	LX1954
FRAM	CA8475
WEGA	JFA425
TECFIL	
<b>MEDIDAS (mm):</b>	
COMPRIMENTO	317
LARGURA	160
ALTURA	54
D. INTERNO	
D. EXTERNO	
ROSCA	
BICOS	

**HONDA**

**FA427S**



<b>OEM:</b>	
17220P13000	
17220P13Z40	
<b>EQUIVALÊNCIAS:</b>	
MANN	C3327
MAHLE	LX840
FRAM	CA7369
WEGA	JFA427
TECFIL	
<b>MEDIDAS (mm):</b>	
COMPRIMENTO	336/212
LARGURA	152/36
ALTURA	49
D. INTERNO	
D. EXTERNO	
ROSCA	
BICOS	

**HONDA**

**FA428S**



<b>OEM:</b>	
17220PLC000	
17220PMRA00	
<b>EQUIVALÊNCIAS:</b>	
MANN	C3221
MAHLE	LX1689
FRAM	CA8911
WEGA	JFA428
TECFIL	ARL1032
<b>MEDIDAS (mm):</b>	
COMPRIMENTO	318/171
LARGURA	198/98
ALTURA	37,4
D. INTERNO	
D. EXTERNO	
ROSCA	
BICOS	



**FA432S**



**OEM:**  
17220PNA003  
17220PNAH01

**EQUIVALÊNCIAS:**

MANN	C1430
MAHLE	
FRAM	CA9493
WEGA	JFA432/1
TECFIL	

**MEDIDAS (mm):**

COMPRIMENTO	
LARGURA	
ALTURA	171
D. INTERNO	83
D. EXTERNO	138,2
ROSCA	
BICOS	

HONDA

**FA434S**



**OEM:**  
17220PWC000  
17220PWA003

**EQUIVALÊNCIAS:**

MANN	C3324
MAHLE	LX1993
FRAM	CA9945
WEGA	JFA428/1
TECFIL	ARL1031

**MEDIDAS (mm):**

COMPRIMENTO	330/244,4
LARGURA	110
ALTURA	39,5
D. INTERNO	
D. EXTERNO	
ROSCA	
BICOS	

HONDA

**FA435S**



**OEM:**  
17220RAAA00  
17220RAAA01

**EQUIVALÊNCIAS:**

MANN	
MAHLE	LX1945
FRAM	CA9564
WEGA	JFA494/2
TECFIL	

**MEDIDAS (mm):**

COMPRIMENTO	270/340,8
LARGURA	100/149,5
ALTURA	40,2
D. INTERNO	
D. EXTERNO	
ROSCA	
BICOS	

HONDA

**FA439S**



**OEM:**  
17220RNA000  
17220RNDM00

**EQUIVALÊNCIAS:**

MANN	C2240
MAHLE	LX2123
FRAM	CA10165
WEGA	JFA429
TECFIL	ARL1034

**MEDIDAS (mm):**

COMPRIMENTO	225
LARGURA	195
ALTURA	40
D. INTERNO	
D. EXTERNO	
ROSCA	
BICOS	

HONDA

**FA440S**



**OEM:**  
17220PWAJ10

**EQUIVALÊNCIAS:**

MANN	C1724
MAHLE	LX1949
FRAM	CA10833
WEGA	JFA428/2
TECFIL	ARL1036

**MEDIDAS (mm):**

COMPRIMENTO	165
LARGURA	146
ALTURA	55
D. INTERNO	
D. EXTERNO	
ROSCA	
BICOS	

HONDA

**FA442S**



**OEM:**  
17220R60U00

**EQUIVALÊNCIAS:**

MANN	
MAHLE	LX2835
FRAM	
WEGA	JFA435
TECFIL	

**MEDIDAS (mm):**

COMPRIMENTO	231
LARGURA	211
ALTURA	48
D. INTERNO	
D. EXTERNO	
ROSCA	
BICOS	

HONDA

**FA443S**



**OEM:**  
17220RL5A00

**EQUIVALÊNCIAS:**

MANN	
MAHLE	LX2688
FRAM	CA10802
WEGA	
TECFIL	

**MEDIDAS (mm):**

COMPRIMENTO	239
LARGURA	211
ALTURA	51
D. INTERNO	
D. EXTERNO	
ROSCA	
BICOS	

HONDA

**FA444S**



**OEM:**  
17220RB0000  
17220RB6Z00

**EQUIVALÊNCIAS:**

MANN	C18004
MAHLE	LX2693
FRAM	CA10650
WEGA	JFA428/3
TECFIL	ARL1035

**MEDIDAS (mm):**

COMPRIMENTO	179
LARGURA	168
ALTURA	58/42
D. INTERNO	
D. EXTERNO	
ROSCA	
BICOS	

HONDA

**FA446S**



**OEM:**  
17220RRAA00

**EQUIVALÊNCIAS:**

MANN	
MAHLE	LX1645
FRAM	CA10359
WEGA	JFA430
TECFIL	

**MEDIDAS (mm):**

COMPRIMENTO	274
LARGURA	259
ALTURA	37
D. INTERNO	
D. EXTERNO	
ROSCA	
BICOS	

HONDA

**FA447S**



**OEM:**  
17220RCAA00  
17220RCJA00

**EQUIVALÊNCIAS:**

MANN	
MAHLE	
FRAM	CA9600
WEGA	JFA494/1
TECFIL	

**MEDIDAS (mm):**

COMPRIMENTO	324
LARGURA	146
ALTURA	43
D. INTERNO	
D. EXTERNO	
ROSCA	
BICOS	

HONDA

**FA448S**



**OEM:**  
17220R70A00  
17220RK2A00

**EQUIVALÊNCIAS:**

MANN	
MAHLE	
FRAM	CA10468
WEGA	JFA434
TECFIL	

**MEDIDAS (mm):**

COMPRIMENTO	261
LARGURA	204
ALTURA	33
D. INTERNO	
D. EXTERNO	
ROSCA	
BICOS	

**FA487S**



**OEM:**  
17220PEHM01  
17220P2NA01

**EQUIVALÊNCIAS:**

MANN	C2055
MAHLE	LX1049
FRAM	CA7764
WEGA	JFA491
TECFIL	

**MEDIDAS (mm):**

COMPRIMENTO	196,4
LARGURA	189,7
ALTURA	42
D. INTERNO	
D. EXTERNO	
ROSCA	
BICOS	

**FA492S**



**OEM:**  
17220P5A000

**EQUIVALÊNCIAS:**

MANN	C2739
MAHLE	LX1951
FRAM	CA8188
WEGA	JFA497
TECFIL	

**MEDIDAS (mm):**

COMPRIMENTO	265,5/214
LARGURA	219/197
ALTURA	40,8
D. INTERNO	
D. EXTERNO	
ROSCA	
BICOS	

**FA495S**



**OEM:**  
17220POA000  
17220POCY00T

**EQUIVALÊNCIAS:**

MANN	C3027/1
MAHLE	LX844
FRAM	CA7420
WEGA	JFA495
TECFIL	

**MEDIDAS (mm):**

COMPRIMENTO	297/129
LARGURA	184,6/100
ALTURA	49,7
D. INTERNO	
D. EXTERNO	
ROSCA	
BICOS	

**FA496S**



**OEM:**  
17220P1K000  
17220PO7000

**EQUIVALÊNCIAS:**

MANN	C2138/3
MAHLE	LX848
FRAM	CA7174
WEGA	JFA499
TECFIL	

**MEDIDAS (mm):**

COMPRIMENTO	208,5
LARGURA	184
ALTURA	36,9
D. INTERNO	
D. EXTERNO	
ROSCA	
BICOS	

**FA497S**



**OEM:**  
17220PY3000

**EQUIVALÊNCIAS:**

MANN	C2730
MAHLE	LX806
FRAM	CA7224
WEGA	JFA497
TECFIL	

**MEDIDAS (mm):**

COMPRIMENTO	263
LARGURA	223/178,8
ALTURA	41,5
D. INTERNO	
D. EXTERNO	
ROSCA	
BICOS	

**FA500S**



**OEM:**  
1500A098

**EQUIVALÊNCIAS:**

MANN	C24011
MAHLE	LX2834
FRAM	CA10355
WEGA	JFA500
TECFIL	ARL4141

**MEDIDAS (mm):**

COMPRIMENTO	240
LARGURA	239
ALTURA	65
D. INTERNO	
D. EXTERNO	
ROSCA	
BICOS	

**FA508S**



**OEM:**  
MZ311785  
MD603384

**EQUIVALÊNCIAS:**

MANN	C24135
MAHLE	LX669
FRAM	CA4369
WEGA	JFA508
TECFIL	

**MEDIDAS (mm):**

COMPRIMENTO	
LARGURA	
ALTURA	146,8
D. INTERNO	152,3/75,6
D. EXTERNO	240,8/163,5
ROSCA	
BICOS	

**FA516S**



**OEM:**  
2811332510  
MD603629

**EQUIVALÊNCIAS:**

MANN	C1891
MAHLE	LX670
FRAM	CA6362
WEGA	JFA516
TECFIL	

**MEDIDAS (mm):**

COMPRIMENTO	
LARGURA	
ALTURA	169,3
D. INTERNO	134,8/111,2
D. EXTERNO	202/191
ROSCA	
BICOS	

**FA523S**



**OEM:**  
MR239466  
MZ311786

**EQUIVALÊNCIAS:**

MANN	C16220
MAHLE	LX1067
FRAM	CAK5722
WEGA	JFA594
TECFIL	AP1009

**MEDIDAS (mm):**

COMPRIMENTO	
LARGURA	
ALTURA	196
D. INTERNO	14,3/88,5
D. EXTERNO	158
ROSCA	
BICOS	



**FA524S**

**MITSUBISHI**



<b>OEM:</b>	
MR404847 XR404847	
<b>EQUIVALÊNCIAS:</b>	
MANN	C3766
MAHLE	LX2885
FRAM	CA9542
WEGA	JFA524
TECFIL	
<b>MEDIDAS (mm):</b>	
COMPRIMENTO	359
LARGURA	237,2
ALTURA	47,8
D. INTERNO	
D. EXTERNO	
ROSCA	
BICOS	

**FA530S**

**MITSUBISHI**



<b>OEM:</b>	
MN135269	
<b>EQUIVALÊNCIAS:</b>	
MANN	
MAHLE	
FRAM	CA10913
WEGA	JFA530
TECFIL	
<b>MEDIDAS (mm):</b>	
COMPRIMENTO	257,5
LARGURA	209
ALTURA	52
D. INTERNO	
D. EXTERNO	
ROSCA	
BICOS	

**FA531S**

**MITSUBISHI**



<b>OEM:</b>	
1500A086 1500A023	
<b>EQUIVALÊNCIAS:</b>	
MANN	C27003
MAHLE	LX2616
FRAM	CA10525
WEGA	JFA509
TECFIL	
<b>MEDIDAS (mm):</b>	
COMPRIMENTO	268
LARGURA	184,5
ALTURA	53,5
D. INTERNO	
D. EXTERNO	
ROSCA	
BICOS	

**FA576S**

**HYUNDAI**



<b>OEM:</b>	
2813045020	
<b>EQUIVALÊNCIAS:</b>	
MANN	C20164
MAHLE	
FRAM	
WEGA	JFA576
TECFIL	
<b>MEDIDAS (mm):</b>	
COMPRIMENTO	
LARGURA	
ALTURA	214
D. INTERNO	130,2
D. EXTERNO	194
ROSCA	
BICOS	

**FA578S**

**HYUNDAI**



<b>OEM:</b>	
2811302510	
<b>EQUIVALÊNCIAS:</b>	
MANN	C2714
MAHLE	LX953
FRAM	CA8734
WEGA	JFA578
TECFIL	
<b>MEDIDAS (mm):</b>	
COMPRIMENTO	265,5
LARGURA	137
ALTURA	27
D. INTERNO	
D. EXTERNO	
ROSCA	
BICOS	

**FA584S**

**PEUGEOT**



<b>OEM:</b>	
95619441	
<b>EQUIVALÊNCIAS:</b>	
MANN	C1468
MAHLE	LX291
FRAM	CA3174
WEGA	FAP0854
TECFIL	
<b>MEDIDAS (mm):</b>	
COMPRIMENTO	193
LARGURA	187
ALTURA	66
D. INTERNO	
D. EXTERNO	
ROSCA	
BICOS	

**FA586S**

**MITSUBISHI**



<b>OEM:</b>	
MD620837 MD620823	
<b>EQUIVALÊNCIAS:</b>	
MANN	C1891
MAHLE	LX839
FRAM	CA7605
WEGA	JFA586
TECFIL	
<b>MEDIDAS (mm):</b>	
COMPRIMENTO	252,5
LARGURA	227,5
ALTURA	46
D. INTERNO	
D. EXTERNO	
ROSCA	
BICOS	

**FA587S**

**MITSUBISHI**



<b>OEM:</b>	
MR188657	
<b>EQUIVALÊNCIAS:</b>	
MANN	C2136/1
MAHLE	LX1076
FRAM	CA8208
WEGA	JFA587
TECFIL	
<b>MEDIDAS (mm):</b>	
COMPRIMENTO	214,3
LARGURA	205
ALTURA	49,2
D. INTERNO	
D. EXTERNO	
ROSCA	
BICOS	

**FA590S**

**HYUNDAI**



<b>OEM:</b>	
2811323001	
<b>EQUIVALÊNCIAS:</b>	
MANN	C2580
MAHLE	LX790
FRAM	CA5881
WEGA	FAP3258
TECFIL	
<b>MEDIDAS (mm):</b>	
COMPRIMENTO	260
LARGURA	180,8
ALTURA	39
D. INTERNO	
D. EXTERNO	
ROSCA	
BICOS	

**FA592S**

**HYUNDAI**



<b>OEM:</b>	
2811322300 2811322301	
<b>EQUIVALÊNCIAS:</b>	
MANN	C2150
MAHLE	LX920
FRAM	CA5646
WEGA	FAP3274
TECFIL	
<b>MEDIDAS (mm):</b>	
COMPRIMENTO	203,5
LARGURA	164
ALTURA	37,3
D. INTERNO	
D. EXTERNO	
ROSCA	
BICOS	

**FA593S**



**HYUNDAI**

<b>OEM:</b>	
2811322051	
<b>EQUIVALÊNCIAS:</b>	
MANN	C2559
MAHLE	LX745
FRAM	CA7775
WEGA	JFA593
TECFIL	
<b>MEDIDAS (mm):</b>	
COMPRIMENTO	245,5
LARGURA	161
ALTURA	38,6
D. INTERNO	
D. EXTERNO	
ROSCA	
BICOS	

**FA596S**



**MITSUBISHI**

<b>OEM:</b>	
MD620737 MD620738	
<b>EQUIVALÊNCIAS:</b>	
MANN	C2335
MAHLE	LX843
FRAM	CA7630
WEGA	JFA596
TECFIL	
<b>MEDIDAS (mm):</b>	
COMPRIMENTO	222,8
LARGURA	200
ALTURA	42,5
D. INTERNO	
D. EXTERNO	
ROSCA	
BICOS	

**FA597S**



**MITSUBISHI**

<b>OEM:</b>	
MD620508	
<b>EQUIVALÊNCIAS:</b>	
MANN	C2626
MAHLE	LX890
FRAM	CA5505
WEGA	JFA597
TECFIL	
<b>MEDIDAS (mm):</b>	
COMPRIMENTO	
LARGURA	
ALTURA	39
D. INTERNO	18,5/82,4
D. EXTERNO	259
ROSCA	
BICOS	

**FA598S**



**MITSUBISHI**

<b>OEM:</b>	
1109100K01 MD620456	
<b>EQUIVALÊNCIAS:</b>	
MANN	C2332
MAHLE	LX989
FRAM	CA7142
WEGA	JFA598
TECFIL	
<b>MEDIDAS (mm):</b>	
COMPRIMENTO	225,6
LARGURA	223,5
ALTURA	33
D. INTERNO	
D. EXTERNO	
ROSCA	
BICOS	

**FA599S**



**MITSUBISHI**

<b>OEM:</b>	
MB906051 KL4713Z40	
<b>EQUIVALÊNCIAS:</b>	
MANN	C2438
MAHLE	LX591
FRAM	CA7344
WEGA	JFA599
TECFIL	
<b>MEDIDAS (mm):</b>	
COMPRIMENTO	233
LARGURA	185
ALTURA	50,8
D. INTERNO	
D. EXTERNO	
ROSCA	
BICOS	

**FA605S**

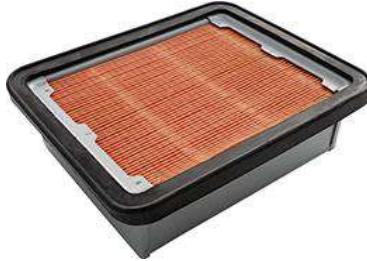

**ASIA**

<b>OEM:</b>	
AA11023603 1780187710	
<b>EQUIVALÊNCIAS:</b>	
MANN	C1158
MAHLE	LX1066
FRAM	CA5499
WEGA	JFA986
TECFIL	ARI1116
<b>MEDIDAS (mm):</b>	
COMPRIMENTO	170
LARGURA	137
ALTURA	59,4
D. INTERNO	
D. EXTERNO	
ROSCA	
BICOS	

**FA611S**



**DAIHATSU / MAZDA / MITSUBISHI**

<b>OEM:</b>	
MD620109 1780154020	
<b>EQUIVALÊNCIAS:</b>	
MANN	C16113/1
MAHLE	LX683
FRAM	CA6938
WEGA	JFA611
TECFIL	AP1009
<b>MEDIDAS (mm):</b>	
COMPRIMENTO	
LARGURA	
ALTURA	156,4
D. INTERNO	14,5/88
D. EXTERNO	154,8
ROSCA	
BICOS	

**FA693S**



**DAIHATSU**

<b>OEM:</b>	
1780197201	
<b>EQUIVALÊNCIAS:</b>	
MANN	C1922
MAHLE	LX2122
FRAM	CA9017
WEGA	JFA693
TECFIL	
<b>MEDIDAS (mm):</b>	
COMPRIMENTO	186
LARGURA	173
ALTURA	52,8
D. INTERNO	
D. EXTERNO	
ROSCA	
BICOS	

**FA694S**



**DAIHATSU**

<b>OEM:</b>	
1780187000 1780187402	
<b>EQUIVALÊNCIAS:</b>	
MANN	C2514
MAHLE	
FRAM	CA9737
WEGA	JFA694
TECFIL	
<b>MEDIDAS (mm):</b>	
COMPRIMENTO	245,5
LARGURA	142,5
ALTURA	43,2
D. INTERNO	
D. EXTERNO	
ROSCA	
BICOS	

**FA697S**



**DAIHATSU**

<b>OEM:</b>	
1780187215	
<b>EQUIVALÊNCIAS:</b>	
MANN	
MAHLE	
FRAM	CA5589
WEGA	JFA697
TECFIL	
<b>MEDIDAS (mm):</b>	
COMPRIMENTO	350,5
LARGURA	116
ALTURA	21
D. INTERNO	
D. EXTERNO	
ROSCA	
BICOS	



**FA714S**

**SUBARU**



<b>OEM:</b>	
16546AA090	
16546AA10A	
<b>EQUIVALÊNCIAS:</b>	
MANN	C2201
MAHLE	LX2672
FRAM	CA9997
WEGA	JFA714
TECFIL	
<b>MEDIDAS (mm):</b>	
COMPRIMENTO	218
LARGURA	216
ALTURA	32
D. INTERNO	
D. EXTERNO	
ROSCA	
BICOS	

**FA716S**

**SUBARU**



<b>OEM:</b>	
16546AA030	
1654673C10	
<b>EQUIVALÊNCIAS:</b>	
MANN	C3483/1
MAHLE	LX59
FRAM	CA4365
WEGA	
TECFIL	
<b>MEDIDAS (mm):</b>	
COMPRIMENTO	226
LARGURA	165
ALTURA	35
D. INTERNO	
D. EXTERNO	
ROSCA	
BICOS	

**FA796S**

**SUBARU**



<b>OEM:</b>	
16546AA070	
16546AA07A	
<b>EQUIVALÊNCIAS:</b>	
MANN	C3747
MAHLE	LX1518
FRAM	CA9019
WEGA	JFA796
TECFIL	
<b>MEDIDAS (mm):</b>	
COMPRIMENTO	371,5
LARGURA	170,2
ALTURA	32
D. INTERNO	
D. EXTERNO	
ROSCA	
BICOS	

**FA799S**

**SUBARU**



<b>OEM:</b>	
16546KA190	
<b>EQUIVALÊNCIAS:</b>	
MANN	
MAHLE	
FRAM	CA5557
WEGA	JFA799
TECFIL	
<b>MEDIDAS (mm):</b>	
COMPRIMENTO	229,2
LARGURA	103
ALTURA	32,3
D. INTERNO	
D. EXTERNO	
ROSCA	
BICOS	

**FA807S**

**SUZUKI**



<b>OEM:</b>	
1378083000	
<b>EQUIVALÊNCIAS:</b>	
MANN	C1980
MAHLE	LX446
FRAM	CA3998
WEGA	JFA807
TECFIL	
<b>MEDIDAS (mm):</b>	
COMPRIMENTO	
LARGURA	
ALTURA	112,7
D. INTERNO	117,6
D. EXTERNO	184
ROSCA	
BICOS	

**FA809S**

**SUZUKI**



<b>OEM:</b>	
1378082400	
1780163010	
<b>EQUIVALÊNCIAS:</b>	
MANN	
MAHLE	LX833
FRAM	CA6377
WEGA	JFA809
TECFIL	
<b>MEDIDAS (mm):</b>	
COMPRIMENTO	
LARGURA	
ALTURA	67,7
D. INTERNO	27,7
D. EXTERNO	172,2
ROSCA	
BICOS	

**FA811S**

**SUZUKI**



<b>OEM:</b>	
1378062B00	
<b>EQUIVALÊNCIAS:</b>	
MANN	C2428
MAHLE	LX842
FRAM	CA5524
WEGA	JFA811
TECFIL	
<b>MEDIDAS (mm):</b>	
COMPRIMENTO	
LARGURA	
ALTURA	33,4
D. INTERNO	15 / 63,7
D. EXTERNO	242,2
ROSCA	
BICOS	

**FA812S**

**SUZUKI**



<b>OEM:</b>	
1378071C50	
1378070C50	
<b>EQUIVALÊNCIAS:</b>	
MANN	
MAHLE	
FRAM	CA5525
WEGA	JFA812
TECFIL	
<b>MEDIDAS (mm):</b>	
COMPRIMENTO	
LARGURA	
ALTURA	34
D. INTERNO	21,4 / 77
D. EXTERNO	236,5
ROSCA	
BICOS	

**FA813S**

**SUZUKI**



<b>OEM:</b>	
1378086000	
1378060B00	
<b>EQUIVALÊNCIAS:</b>	
MANN	C2223
MAHLE	LX544
FRAM	CA6376
WEGA	JFA813
TECFIL	
<b>MEDIDAS (mm):</b>	
COMPRIMENTO	
LARGURA	
ALTURA	42,2
D. INTERNO	20,7/65,2
D. EXTERNO	239
ROSCA	
BICOS	

**FA815S**

**SUZUKI**



<b>OEM:</b>	
1378081A00	
1378081AU0	
<b>EQUIVALÊNCIAS:</b>	
MANN	C2074
MAHLE	LX1061
FRAM	CA9728
WEGA	JFA815
TECFIL	
<b>MEDIDAS (mm):</b>	
COMPRIMENTO	191
LARGURA	158,2
ALTURA	52,5
D. INTERNO	
D. EXTERNO	
ROSCA	
BICOS	

**FA824S**

**SUZUKI**



<b>OEM:</b>	
1378065J00	
<b>EQUIVALÊNCIAS:</b>	
MANN	C2330
MAHLE	LX2612
FRAM	
WEGA	JFA893
TECFIL	
<b>MEDIDAS (mm):</b>	
COMPRIMENTO	174/229
LARGURA	120/178
ALTURA	50
D. INTERNO	
D. EXTERNO	
ROSCA	
BICOS	

**FA831S**

**SUZUKI**



<b>OEM:</b>	
1378078K00	
<b>EQUIVALÊNCIAS:</b>	
MANN	
MAHLE	
FRAM	CA10839
WEGA	
TECFIL	
<b>MEDIDAS (mm):</b>	
COMPRIMENTO	241
LARGURA	216
ALTURA	50
D. INTERNO	
D. EXTERNO	
ROSCA	
BICOS	

**FA884S**

**SUZUKI**



<b>OEM:</b>	
1378080GA0	
<b>EQUIVALÊNCIAS:</b>	
MANN	C2622
MAHLE	
FRAM	
WEGA	JFA884
TECFIL	
<b>MEDIDAS (mm):</b>	
COMPRIMENTO	267,5
LARGURA	173,5
ALTURA	31,3
D. INTERNO	
D. EXTERNO	
ROSCA	
BICOS	

**FA885S**

**CHANA**



<b>OEM:</b>	
1378077A00 Y011020	
<b>EQUIVALÊNCIAS:</b>	
MANN	
MAHLE	
FRAM	CA9728
WEGA	JFAF10
TECFIL	
<b>MEDIDAS (mm):</b>	
COMPRIMENTO	241,2
LARGURA	143,7
ALTURA	52
D. INTERNO	
D. EXTERNO	
ROSCA	
BICOS	

**FA886S**

**SUZUKI**



<b>OEM:</b>	
1378054G00	
<b>EQUIVALÊNCIAS:</b>	
MANN	
MAHLE	LX1690
FRAM	
WEGA	
TECFIL	
<b>MEDIDAS (mm):</b>	
COMPRIMENTO	179
LARGURA	162
ALTURA	58,8
D. INTERNO	
D. EXTERNO	
ROSCA	
BICOS	

**FA889S**

**SUZUKI**



<b>OEM:</b>	
1378075F00	
<b>EQUIVALÊNCIAS:</b>	
MANN	
MAHLE	LX1588
FRAM	CA9488
WEGA	JFA889
TECFIL	
<b>MEDIDAS (mm):</b>	
COMPRIMENTO	233,4
LARGURA	135,2
ALTURA	41,2
D. INTERNO	
D. EXTERNO	
ROSCA	
BICOS	

**FA891S**

**SUZUKI**



<b>OEM:</b>	
1378061A00 1378061A10	
<b>EQUIVALÊNCIAS:</b>	
MANN	C2697
MAHLE	LX485
FRAM	CA6664
WEGA	JFA810
TECFIL	
<b>MEDIDAS (mm):</b>	
COMPRIMENTO	256,2
LARGURA	206
ALTURA	43
D. INTERNO	
D. EXTERNO	
ROSCA	
BICOS	

**FA896S**

**SUZUKI**



<b>OEM:</b>	
1378060G00 1378065G50	
<b>EQUIVALÊNCIAS:</b>	
MANN	C1924
MAHLE	LX861
FRAM	CA5687
WEGA	JFA896
TECFIL	
<b>MEDIDAS (mm):</b>	
COMPRIMENTO	190
LARGURA	154,6
ALTURA	52
D. INTERNO	
D. EXTERNO	
ROSCA	
BICOS	

**FA897S**

**CHEVROLET / SUZUKI**



<b>OEM:</b>	
1378077E00 1378077EU0	
<b>EQUIVALÊNCIAS:</b>	
MANN	C2337
MAHLE	LX862
FRAM	CA8069
WEGA	JFA897
TECFIL	ARL8827
<b>MEDIDAS (mm):</b>	
COMPRIMENTO	230
LARGURA	201
ALTURA	54,5
D. INTERNO	
D. EXTERNO	
ROSCA	
BICOS	

**FA898S**

**SUZUKI**



<b>OEM:</b>	
1378058B00 1378058BU0	
<b>EQUIVALÊNCIAS:</b>	
MANN	C2736/1
MAHLE	LX863
FRAM	CA7617
WEGA	JFA898
TECFIL	
<b>MEDIDAS (mm):</b>	
COMPRIMENTO	296
LARGURA	141,2
ALTURA	52,7
D. INTERNO	
D. EXTERNO	
ROSCA	
BICOS	



**FA899S**

**SUZUKI**



<b>OEM:</b>	
1378057B00	
<b>EQUIVALÊNCIAS:</b>	
MANN	LX834
MAHLE	CA5686
FRAM	
WEGA	
TECFIL	
<b>MEDIDAS (mm):</b>	
COMPRIMENTO	284,7
LARGURA	142,2
ALTURA	51,2
D. INTERNO	
D. EXTERNO	
ROSCA	
BICOS	

**FA907S**

**MB / SSANGYONG**



<b>OEM:</b>	
6020940204 6020940104	
<b>EQUIVALÊNCIAS:</b>	
MANN	C38163/1
MAHLE	LX96
FRAM	CA4580
WEGA	FAP4014
TECFIL	
<b>MEDIDAS (mm):</b>	
COMPRIMENTO	378,2
LARGURA	171
ALTURA	50,5
D. INTERNO	
D. EXTERNO	
ROSCA	
BICOS	

**FA908S**

**JEEP**



<b>OEM:</b>	
05018777AB 05018777AA	
<b>EQUIVALÊNCIAS:</b>	
MANN	C2975
MAHLE	LX1662
FRAM	CA8817
WEGA	FAP2844
TECFIL	
<b>MEDIDAS (mm):</b>	
COMPRIMENTO	289,5
LARGURA	210
ALTURA	41,2
D. INTERNO	
D. EXTERNO	
ROSCA	
BICOS	

**FA910S**

**JEEP**



<b>OEM:</b>	
04861688AA K04861688AA	
<b>EQUIVALÊNCIAS:</b>	
MANN	
MAHLE	LX2108
FRAM	
WEGA	
TECFIL	
<b>MEDIDAS (mm):</b>	
COMPRIMENTO	222
LARGURA	212
ALTURA	50
D. INTERNO	
D. EXTERNO	
ROSCA	
BICOS	

**FA911S**

**CHRYSLER**



<b>OEM:</b>	
5019002AA 5037615AA	
<b>EQUIVALÊNCIAS:</b>	
MANN	
MAHLE	
FRAM	CA9838
WEGA	FAP2845
TECFIL	
<b>MEDIDAS (mm):</b>	
COMPRIMENTO	292
LARGURA	212
ALTURA	39
D. INTERNO	
D. EXTERNO	
ROSCA	
BICOS	

**FA914S**

**CHRYSLER**



<b>OEM:</b>	
05098424AA 1120940304	
<b>EQUIVALÊNCIAS:</b>	
MANN	C2861/2
MAHLE	LX1137/S
FRAM	CA9689
WEGA	FAP3232
TECFIL	
<b>MEDIDAS (mm):</b>	
COMPRIMENTO	271
LARGURA	118
ALTURA	39/50
D. INTERNO	
D. EXTERNO	
ROSCA	
BICOS	

**FA915S**

**JEEP**



<b>OEM:</b>	
53034019AD 53034018AE	
<b>EQUIVALÊNCIAS:</b>	
MANN	
MAHLE	
FRAM	CA10348
WEGA	JFA988
TECFIL	
<b>MEDIDAS (mm):</b>	
COMPRIMENTO	295
LARGURA	210
ALTURA	65
D. INTERNO	
D. EXTERNO	
ROSCA	
BICOS	

**FA974S**

**CHRYSLER / DODGE**



<b>OEM:</b>	
4861480AA 4891713AA	
<b>EQUIVALÊNCIAS:</b>	
MANN	C24100
MAHLE	
FRAM	CA9054
WEGA	FAP9033
TECFIL	
<b>MEDIDAS (mm):</b>	
COMPRIMENTO	237,8
LARGURA	214,8
ALTURA	45
D. INTERNO	
D. EXTERNO	
ROSCA	
BICOS	

**FA975S**

**JEEP**

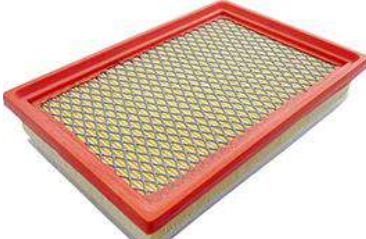

<b>OEM:</b>	
53030730	
<b>EQUIVALÊNCIAS:</b>	
MANN	
MAHLE	
FRAM	CA8858
WEGA	JFA975
TECFIL	
<b>MEDIDAS (mm):</b>	
COMPRIMENTO	236,2
LARGURA	160,6
ALTURA	48
D. INTERNO	
D. EXTERNO	
ROSCA	
BICOS	

**FA977S**

**HONDA**



<b>OEM:</b>	
8970353030 178010W010	
<b>EQUIVALÊNCIAS:</b>	
MANN	C3145
MAHLE	LX1740
FRAM	CA7417
WEGA	JFA977
TECFIL	
<b>MEDIDAS (mm):</b>	
COMPRIMENTO	309
LARGURA	203
ALTURA	51
D. INTERNO	
D. EXTERNO	
ROSCA	
BICOS	

**SSANGYONG**

**FA978S**



<b>OEM:</b>	
6010940404	
<b>EQUIVALÊNCIAS:</b>	
MANN	C29126/2
MAHLE	LX95
FRAM	CA5144
WEGA	FAP4006
TECFIL	
<b>MEDIDAS (mm):</b>	
COMPRIMENTO	289
LARGURA	171
ALTURA	50
D. INTERNO	
D. EXTERNO	
ROSCA	
BICOS	

**SSANGYONG**

**FA980S**



<b>OEM:</b>	
2319005320 6040940504	
<b>EQUIVALÊNCIAS:</b>	
MANN	C34175
MAHLE	LX517
FRAM	CA5782
WEGA	FAP4853
TECFIL	
<b>MEDIDAS (mm):</b>	
COMPRIMENTO	278,2
LARGURA	190
ALTURA	58
D. INTERNO	
D. EXTERNO	
ROSCA	
BICOS	

**KIA**

**FA982S**



<b>OEM:</b>	
OK9A213Z40 OK9A213Z40	
<b>EQUIVALÊNCIAS:</b>	
MANN	C3032/3
MAHLE	LX1022
FRAM	CA9233
WEGA	JFA982
TECFIL	
<b>MEDIDAS (mm):</b>	
COMPRIMENTO	302,2
LARGURA	125/203
ALTURA	36
D. INTERNO	
D. EXTERNO	
ROSCA	
BICOS	

**ASIA**

**FA983S**



<b>OEM:</b>	
OK79023603 OK79023603B	
<b>EQUIVALÊNCIAS:</b>	
MANN	C18142
MAHLE	LX1097
FRAM	CA5813
WEGA	JFA983
TECFIL	AP1001
<b>MEDIDAS (mm):</b>	
COMPRIMENTO	
LARGURA	
ALTURA	138
D. INTERNO	90,7
D. EXTERNO	173,2/217,7
ROSCA	
BICOS	

**JEEP / NISSAN**

**FA985S**



<b>OEM:</b>	
53030688 53007386	
<b>EQUIVALÊNCIAS:</b>	
MANN	C28150
MAHLE	LX1272
FRAM	CA7440
WEGA	JFA985
TECFIL	
<b>MEDIDAS (mm):</b>	
COMPRIMENTO	289
LARGURA	244
ALTURA	41
D. INTERNO	
D. EXTERNO	
ROSCA	
BICOS	

**DODGE / JEEP**

**FA987S**



<b>OEM:</b>	
27133843 49133843	
<b>EQUIVALÊNCIAS:</b>	
MANN	C2860
MAHLE	LX259
FRAM	CA3660
WEGA	FAP3231
TECFIL	
<b>MEDIDAS (mm):</b>	
COMPRIMENTO	272,5
LARGURA	134
ALTURA	40
D. INTERNO	
D. EXTERNO	
ROSCA	
BICOS	

**DODGE / JEEP**

**FA990S**



<b>OEM:</b>	
8953004383	
<b>EQUIVALÊNCIAS:</b>	
MANN	C3594/1
MAHLE	LX577
FRAM	CA3901
WEGA	FAP3218
TECFIL	AP5572
<b>MEDIDAS (mm):</b>	
COMPRIMENTO	343,8
LARGURA	169
ALTURA	41
D. INTERNO	
D. EXTERNO	
ROSCA	
BICOS	

**HYUNDAI / MITSUBISHI**

**FA991S**



<b>OEM:</b>	
MD603446 2813044000	
<b>EQUIVALÊNCIAS:</b>	
MANN	C14179
MAHLE	LX16
FRAM	CAK253
WEGA	JFA514
TECFIL	AP5080
<b>MEDIDAS (mm):</b>	
COMPRIMENTO	
LARGURA	
ALTURA	287,2
D. INTERNO	14,4/68
D. EXTERNO	132/135,6
ROSCA	
BICOS	

**FORD / VW**

**FA991SG**



<b>OEM:</b>	
305080 2813044000	
<b>EQUIVALÊNCIAS:</b>	
MANN	C14160
MAHLE	LX200
FRAM	CA3105
WEGA	JFA514/1
TECFIL	AP8528
<b>MEDIDAS (mm):</b>	
COMPRIMENTO	
LARGURA	
ALTURA	295
D. INTERNO	64/10,5
D. EXTERNO	126,7
ROSCA	
BICOS	

**CHEVROLET / RENAULT**

**FA0130S**



<b>OEM:</b>	
7701040780 7701348175	
<b>EQUIVALÊNCIAS:</b>	
MANN	C1380
MAHLE	LX290
FRAM	CA3154
WEGA	WR275
TECFIL	AR7702
<b>MEDIDAS (mm):</b>	
COMPRIMENTO	
LARGURA	
ALTURA	220
D. INTERNO	86
D. EXTERNO	128
ROSCA	
BICOS	



**FA0202S**

**FORD**



<b>OEM:</b>	
6497632 89BF9601AA	
<b>EQUIVALÊNCIAS:</b>	
MANN	C3032/1
MAHLE	LX332
FRAM	CA5160
WEGA	WR251
TECFIL	
<b>MEDIDAS (mm):</b>	
<b>COMPRIMENTO</b>	
LARGURA	
ALTURA	52
D. INTERNO	245
D. EXTERNO	293
ROSCA	
BICOS	

**FA0205S**

**CITROËN / PEUGEOT**



<b>OEM:</b>	
1444A7 95658433	
<b>EQUIVALÊNCIAS:</b>	
MANN	C1460
MAHLE	LX384
FRAM	CA5329
WEGA	WR311
TECFIL	
<b>MEDIDAS (mm):</b>	
<b>COMPRIMENTO</b>	
LARGURA	
ALTURA	165
D. INTERNO	91
D. EXTERNO	130
ROSCA	
BICOS	

**FA0268S**

**ALFA ROMEO**



<b>OEM:</b>	
60811342 608113421	
<b>EQUIVALÊNCIAS:</b>	
MANN	C1589/3
MAHLE	LX914
FRAM	CA5612
WEGA	WR348/1
TECFIL	
<b>MEDIDAS (mm):</b>	
<b>COMPRIMENTO</b>	
LARGURA	
ALTURA	257
D. INTERNO	103
D. EXTERNO	150
ROSCA	
BICOS	

**FA0610S**

**IVECO**



<b>OEM:</b>	
1908233 1908868	
<b>EQUIVALÊNCIAS:</b>	
MANN	C16247/1
MAHLE	LX610
FRAM	CA5787
WEGA	WR406/2
TECFIL	ARS8233
<b>MEDIDAS (mm):</b>	
<b>COMPRIMENTO</b>	
LARGURA	
ALTURA	344
D. INTERNO	80
D. EXTERNO	155
ROSCA	
BICOS	

**FA1006S**

**KIA**



<b>OEM:</b>	
K59223603 59223603	
<b>EQUIVALÊNCIAS:</b>	
MANN	C18115
MAHLE	
FRAM	CA5499
WEGA	JFAK02/1
TECFIL	AP1006
<b>MEDIDAS (mm):</b>	
<b>COMPRIMENTO</b>	
LARGURA	
ALTURA	159
D. INTERNO	116
D. EXTERNO	180
ROSCA	
BICOS	

**FA1116S**

**ASIA**

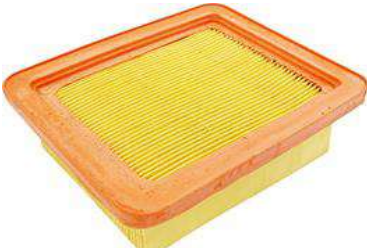

<b>OEM:</b>	
AA11023603 1780187710	
<b>EQUIVALÊNCIAS:</b>	
MANN	C1158
MAHLE	LX1066
FRAM	CA5499
WEGA	JFA986
TECFIL	ARL1116
<b>MEDIDAS (mm):</b>	
<b>COMPRIMENTO</b>	
LARGURA	172
ALTURA	138
ALTURA	58
D. INTERNO	
D. EXTERNO	
ROSCA	
BICOS	

**FA14200S**

**CHEVROLET / VW**



<b>OEM:</b>	
217129620 93276069	
<b>EQUIVALÊNCIAS:</b>	
MANN	C14200
MAHLE	LX960
FRAM	CA5961PU
WEGA	WR200/3
TECFIL	ARS2868
<b>MEDIDAS (mm):</b>	
<b>COMPRIMENTO</b>	
LARGURA	
ALTURA	320
D. INTERNO	74
D. EXTERNO	124
ROSCA	
BICOS	

**FA15300S**

**MITSUBISHI / NISSAN**



<b>OEM:</b>	
2903849 905412970059	
<b>EQUIVALÊNCIAS:</b>	
MANN	C15300
MAHLE	LX1687/1
FRAM	CA9744
WEGA	WR200/4
TECFIL	ARS7109
<b>MEDIDAS (mm):</b>	
<b>COMPRIMENTO</b>	
LARGURA	
ALTURA	359
D. INTERNO	84
D. EXTERNO	149
ROSCA	
BICOS	

**FA16244S**

**FORD**



<b>OEM:</b>	
51559601AA	
<b>EQUIVALÊNCIAS:</b>	
MANN	C16244
MAHLE	LX2124
FRAM	CA10111
WEGA	WR198
TECFIL	ARS7993
<b>MEDIDAS (mm):</b>	
<b>COMPRIMENTO</b>	
LARGURA	269
ALTURA	
D. INTERNO	98
D. EXTERNO	158
ROSCA	
BICOS	

**FA1805S**

**FIAT**



<b>OEM:</b>	
46761805	
<b>EQUIVALÊNCIAS:</b>	
MANN	C11127
MAHLE	LX2526
FRAM	CA9129PU
WEGA	WR200/2
TECFIL	ARS1029
<b>MEDIDAS (mm):</b>	
<b>COMPRIMENTO</b>	
LARGURA	
ALTURA	315
D. INTERNO	59
D. EXTERNO	110
ROSCA	
BICOS	

**LEXUS / TOYOTA**

**FA2000S**



<b>OEM:</b>	
1780137020 1780137021	
<b>EQUIVALÊNCIAS:</b>	
MANN	C22009
MAHLE	LX2870
FRAM	CA10741
WEGA	
TECFIL	
<b>MEDIDAS (mm):</b>	
COMPRIMENTO	220
LARGURA	187
ALTURA	36
D. INTERNO	
D. EXTERNO	
ROSCA	
BICOS	

**LEXUS**

**FA2001S**



<b>OEM:</b>	
1780138010 178010V020	
<b>EQUIVALÊNCIAS:</b>	
MANN	
MAHLE	LX2992
FRAM	CA10677
WEGA	JFA287
TECFIL	
<b>MEDIDAS (mm):</b>	
COMPRIMENTO	273
LARGURA	180
ALTURA	35
D. INTERNO	
D. EXTERNO	
ROSCA	
BICOS	

**ALFA ROMEO**

**FA2005S**



<b>OEM:</b>	
60510292 71736138	
<b>EQUIVALÊNCIAS:</b>	
MANN	C3471
MAHLE	LX458
FRAM	CA4599
WEGA	FAP2005
TECFIL	
<b>MEDIDAS (mm):</b>	
COMPRIMENTO	335
LARGURA	230
ALTURA	23,5
D. INTERNO	
D. EXTERNO	
ROSCA	
BICOS	

**MB**

**FA2006S**



<b>OEM:</b>	
40941604 0040941604	
<b>EQUIVALÊNCIAS:</b>	
MANN	C3479
MAHLE	LX781
FRAM	CA4599
WEGA	FAP2006
TECFIL	
<b>MEDIDAS (mm):</b>	
COMPRIMENTO	337
LARGURA	190
ALTURA	31
D. INTERNO	
D. EXTERNO	
ROSCA	
BICOS	

**FORD**

**FA2007S**



<b>OEM:</b>	
2N1U9601BD 2NVU9601BD	
<b>EQUIVALÊNCIAS:</b>	
MANN	C4151
MAHLE	LX1597
FRAM	CA9511
WEGA	FAP9003
TECFIL	ARL9608
<b>MEDIDAS (mm):</b>	
COMPRIMENTO	412
LARGURA	128
ALTURA	30
D. INTERNO	
D. EXTERNO	
ROSCA	
BICOS	

**AGRALE**

**FA20500S**



<b>OEM:</b>	
3901477M1 3901477M2	
<b>EQUIVALÊNCIAS:</b>	
MANN	C20500
MAHLE	LX1314
FRAM	CA9352
WEGA	WAP606
TECFIL	ARS3003
<b>MEDIDAS (mm):</b>	
COMPRIMENTO	
LARGURA	
ALTURA	400
D. INTERNO	114
D. EXTERNO	194
ROSCA	
BICOS	

**IVECO**

**FA2124S**



<b>OEM:</b>	
41272124 2996126	
<b>EQUIVALÊNCIAS:</b>	
MANN	C321420/1
MAHLE	LX2082
FRAM	CA5699
WEGA	
TECFIL	ARS8235
<b>MEDIDAS (mm):</b>	
COMPRIMENTO	
LARGURA	
ALTURA	463
D. INTERNO	206,5
D. EXTERNO	311,5
ROSCA	
BICOS	

**MINI COOPER**

**FA2414S**



<b>OEM:</b>	
13721491749	
<b>EQUIVALÊNCIAS:</b>	
MANN	C2851
MAHLE	LX1269
FRAM	CA9899
WEGA	FAP2412
TECFIL	
<b>MEDIDAS (mm):</b>	
COMPRIMENTO	276
LARGURA	168
ALTURA	34,3
D. INTERNO	
D. EXTERNO	
ROSCA	
BICOS	

**RENAULT**

**FA2680S**



<b>OEM:</b>	
7701069211 7701069212	
<b>EQUIVALÊNCIAS:</b>	
MANN	C2680
MAHLE	LX2830
FRAM	
WEGA	WR245
TECFIL	AR7705
<b>MEDIDAS (mm):</b>	
COMPRIMENTO	
LARGURA	
ALTURA	91
D. INTERNO	200
D. EXTERNO	260
ROSCA	
BICOS	

**VOLVO**

**FA2830S**



<b>OEM:</b>	
30812710 308127109	
<b>EQUIVALÊNCIAS:</b>	
MANN	C3594
MAHLE	LX503
FRAM	CA5751
WEGA	FAP2830
TECFIL	
<b>MEDIDAS (mm):</b>	
COMPRIMENTO	343
LARGURA	169
ALTURA	35
D. INTERNO	
D. EXTERNO	
ROSCA	
BICOS	



**FA2869S**

CHEVROLET

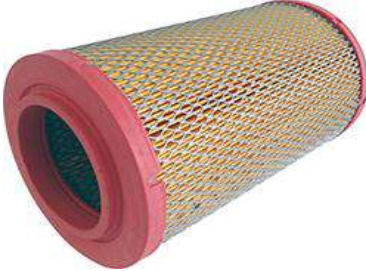

<b>OEM:</b>	
93321112	
<b>EQUIVALÊNCIAS:</b>	
MANN	C16197
MAHLE	LX2529
FRAM	CA8852
WEGA	WR200/7
TECFIL	ARS2869
<b>MEDIDAS (mm):</b>	
COMPRIMENTO	
LARGURA	
ALTURA	275
D. INTERNO	161 / 91
D. EXTERNO	
ROSCA	
BICOS	

**FA2955S**

MB



<b>OEM:</b>	
1660940004	
<b>EQUIVALÊNCIAS:</b>	
MANN	C1381
MAHLE	LX794
FRAM	CA8789
WEGA	WR327/1
TECFIL	AR2955
<b>MEDIDAS (mm):</b>	
COMPRIMENTO	
LARGURA	
ALTURA	150
D. INTERNO	59
D. EXTERNO	124
ROSCA	
BICOS	

**FA3241S**

FORD



<b>OEM:</b>	
1665410 93BB9601AB	
<b>EQUIVALÊNCIAS:</b>	
MANN	C40107
MAHLE	LX522
FRAM	CA5494
WEGA	FAP3241
TECFIL	ARL5410
<b>MEDIDAS (mm):</b>	
COMPRIMENTO	397
LARGURA	150
ALTURA	42
D. INTERNO	
D. EXTERNO	
ROSCA	
BICOS	

**FA3242S**

RENAULT



<b>OEM:</b>	
7701036270	
<b>EQUIVALÊNCIAS:</b>	
MANN	C3042/1
MAHLE	LX509
FRAM	CA5463
WEGA	FAP3242
TECFIL	
<b>MEDIDAS (mm):</b>	
COMPRIMENTO	297
LARGURA	88
ALTURA	42
D. INTERNO	
D. EXTERNO	
ROSCA	
BICOS	

**FA3243S**

MB



<b>OEM:</b>	
0030946104 30946104	
<b>EQUIVALÊNCIAS:</b>	
MANN	C33102
MAHLE	LX348
FRAM	CA6844
WEGA	FAP3243
TECFIL	
<b>MEDIDAS (mm):</b>	
COMPRIMENTO	332
LARGURA	156
ALTURA	44
D. INTERNO	
D. EXTERNO	
ROSCA	
BICOS	

**FA3256S**

BMW



<b>OEM:</b>	
13721247405 13721247637	
<b>EQUIVALÊNCIAS:</b>	
MANN	C2493
MAHLE	LX500
FRAM	CA5641
WEGA	FAP3256
TECFIL	
<b>MEDIDAS (mm):</b>	
COMPRIMENTO	236
LARGURA	235
ALTURA	42
D. INTERNO	
D. EXTERNO	
ROSCA	
BICOS	

**FA3603S**

VOLVO



<b>OEM:</b>	
30862730 30873414	
<b>EQUIVALÊNCIAS:</b>	
MANN	C35124
MAHLE	LX662
FRAM	CA8888
WEGA	FAP3603
TECFIL	
<b>MEDIDAS (mm):</b>	
COMPRIMENTO	343
LARGURA	169
ALTURA	46
D. INTERNO	
D. EXTERNO	
ROSCA	
BICOS	

**FA3606S**

VOLVO



<b>OEM:</b>	
3528093 9141094	
<b>EQUIVALÊNCIAS:</b>	
MANN	C35148
MAHLE	LX686
FRAM	CA5436
WEGA	FAP3606
TECFIL	
<b>MEDIDAS (mm):</b>	
COMPRIMENTO	348
LARGURA	184,5
ALTURA	49
D. INTERNO	
D. EXTERNO	
ROSCA	
BICOS	

**FA3610S**

FORD



<b>OEM:</b>	
1072246 98AB9601CB	
<b>EQUIVALÊNCIAS:</b>	
MANN	C2774/3
MAHLE	LX798
FRAM	CA5929
WEGA	FAP3610
TECFIL	ARL9607
<b>MEDIDAS (mm):</b>	
COMPRIMENTO	267
LARGURA	147,5
ALTURA	45
D. INTERNO	
D. EXTERNO	
ROSCA	
BICOS	

**FA3612S**

MB



<b>OEM:</b>	
6040941004 6040940904	
<b>EQUIVALÊNCIAS:</b>	
MANN	C24106
MAHLE	LX539
FRAM	CA8889
WEGA	FAP3612
TECFIL	
<b>MEDIDAS (mm):</b>	
COMPRIMENTO	201
LARGURA	235
ALTURA	46
D. INTERNO	
D. EXTERNO	
ROSCA	
BICOS	

**FA3615S**

CITROËN / PEUGEOT



OEM:	
1444X0	
1444CZ	
EQUIVALÊNCIAS:	
MANN	C3468
MAHLE	LX1257
FRAM	CA9315
WEGA	FAP3615
TECFIL	ARL5053
MEDIDAS (mm):	
COMPRIMENTO	333
LARGURA	110
ALTURA	45
D. INTERNO	
D. EXTERNO	
ROSCA	
BICOS	

**FA4023S**

CITROËN / PEUGEOT



OEM:	
9401444108	
144410	
EQUIVALÊNCIAS:	
MANN	C35134
MAHLE	LX333
FRAM	CA5228
WEGA	FAP4023
TECFIL	
MEDIDAS (mm):	
COMPRIMENTO	343
LARGURA	117
ALTURA	50
D. INTERNO	
D. EXTERNO	
ROSCA	
BICOS	

**FA4037S**

CITROËN / PEUGEOT



OEM:	
144486	
7701042841	
EQUIVALÊNCIAS:	
MANN	C3173
MAHLE	LX488
FRAM	CA5488
WEGA	FAP4037
TECFIL	ARL8106
MEDIDAS (mm):	
COMPRIMENTO	297
LARGURA	101,5
ALTURA	49
D. INTERNO	
D. EXTERNO	
ROSCA	
BICOS	

**FA4052S**

MB



OEM:	
1120940604	
1120940004	
EQUIVALÊNCIAS:	
MANN	C3698/32
MAHLE	LX804/S
FRAM	CA8768
WEGA	FAP4052
TECFIL	
MEDIDAS (mm):	
COMPRIMENTO	355
LARGURA	134,5
ALTURA	50
D. INTERNO	
D. EXTERNO	
ROSCA	
BICOS	

**FA4053S**

FORD



OEM:	
1120167	
1S719601AA	
EQUIVALÊNCIAS:	
MANN	C3498
MAHLE	LX978
FRAM	CA9126
WEGA	FAP4053
TECFIL	
MEDIDAS (mm):	
COMPRIMENTO	340
LARGURA	143
ALTURA	50
D. INTERNO	
D. EXTERNO	
ROSCA	
BICOS	

**FA4054S**

PEUGEOT



OEM:	
1444W2	
1444W3	
EQUIVALÊNCIAS:	
MANN	C25101
MAHLE	LX1044
FRAM	CA9082
WEGA	FAP4054
TECFIL	ARL8108
MEDIDAS (mm):	
COMPRIMENTO	246
LARGURA	168
ALTURA	49
D. INTERNO	
D. EXTERNO	
ROSCA	
BICOS	

**FA4073S**

MB



OEM:	
2660940004	
EQUIVALÊNCIAS:	
MANN	C2287
MAHLE	LX1652
FRAM	CA10050
WEGA	FAP9017
TECFIL	
MEDIDAS (mm):	
COMPRIMENTO	219
LARGURA	173
ALTURA	50
D. INTERNO	
D. EXTERNO	
ROSCA	
BICOS	

**FA4077S**

CITROËN / PEUGEOT



OEM:	
1444FF	
1444PR	
EQUIVALÊNCIAS:	
MANN	C4292
MAHLE	LX1745
FRAM	CA10237
WEGA	FAP4054/2
TECFIL	ARL5049
MEDIDAS (mm):	
COMPRIMENTO	425
LARGURA	94
ALTURA	50
D. INTERNO	
D. EXTERNO	
ROSCA	
BICOS	

**FA4206S**

ALFA ROMEO



OEM:	
46741119	
4674119	
EQUIVALÊNCIAS:	
MANN	C3188
MAHLE	LX1026
FRAM	CA9094
WEGA	FAP4206
TECFIL	
MEDIDAS (mm):	
COMPRIMENTO	307
LARGURA	135
ALTURA	50
D. INTERNO	
D. EXTERNO	
ROSCA	
BICOS	

**FA4812S**

CITROËN / PEUGEOT



OEM:	
1444A4	
1444W8	
EQUIVALÊNCIAS:	
MANN	C33156
MAHLE	LX572
FRAM	CA5111
WEGA	FAP4812
TECFIL	ARL8103
MEDIDAS (mm):	
COMPRIMENTO	325
LARGURA	155
ALTURA	58
D. INTERNO	
D. EXTERNO	
ROSCA	
BICOS	



**FA4813S**

**AUDI / BMW / CHEVROLET**



<b>OEM:</b>	
25062055	
58133843	
<b>EQUIVALÊNCIAS:</b>	
MANN	C26168
MAHLE	LX448
FRAM	CA5108
WEGA	FAP4813
TECFIL	ARL8837
<b>MEDIDAS (mm):</b>	
COMPRIMENTO	252
LARGURA	211
ALTURA	58
D. INTERNO	
D. EXTERNO	
ROSCA	
BICOS	

**FA4817S**

**BMW**



<b>OEM:</b>	
13721707050	
12721734682	
<b>EQUIVALÊNCIAS:</b>	
MANN	C26110/1
MAHLE	LX105
FRAM	CA4576
WEGA	FAP4817
TECFIL	ARL8836
<b>MEDIDAS (mm):</b>	
COMPRIMENTO	256
LARGURA	149,5
ALTURA	57,5
D. INTERNO	
D. EXTERNO	
ROSCA	
BICOS	

**FA4818S**

**BMW**



<b>OEM:</b>	
13721707021	
13721714952	
<b>EQUIVALÊNCIAS:</b>	
MANN	C39161
MAHLE	LX106
FRAM	CA5149
WEGA	FAP4818
TECFIL	
<b>MEDIDAS (mm):</b>	
COMPRIMENTO	381
LARGURA	149,5
ALTURA	57,5
D. INTERNO	
D. EXTERNO	
ROSCA	
BICOS	

**FA4823S**

**VOLVO**



<b>OEM:</b>	
34147090	
34344952	
<b>EQUIVALÊNCIAS:</b>	
MANN	C32120
MAHLE	LX492
FRAM	CA5233
WEGA	FAP4823
TECFIL	
<b>MEDIDAS (mm):</b>	
COMPRIMENTO	312
LARGURA	149,5
ALTURA	57
D. INTERNO	
D. EXTERNO	
ROSCA	
BICOS	

**FA4826S**

**SEAT / VW**



<b>OEM:</b>	
1L0129601C	
1L0129620	
<b>EQUIVALÊNCIAS:</b>	
MANN	C28136/1
MAHLE	LX418
FRAM	CA5377
WEGA	FAP4826
TECFIL	ARL6094
<b>MEDIDAS (mm):</b>	
COMPRIMENTO	276
LARGURA	185
ALTURA	57,5
D. INTERNO	
D. EXTERNO	
ROSCA	
BICOS	

**FA4827S**

**VW**



<b>OEM:</b>	
1HO129620	
0986B02309	
<b>EQUIVALÊNCIAS:</b>	
MANN	C27154/1
MAHLE	LX405
FRAM	CA5370
WEGA	FAP4827
TECFIL	ARL6092
<b>MEDIDAS (mm):</b>	
COMPRIMENTO	267
LARGURA	228
ALTURA	57
D. INTERNO	
D. EXTERNO	
ROSCA	
BICOS	

**FA4828S**

**BMW**



<b>OEM:</b>	
13721738463	
13721311880	
<b>EQUIVALÊNCIAS:</b>	
MANN	C33130
MAHLE	LX408
FRAM	CA5351
WEGA	FAP4828
TECFIL	
<b>MEDIDAS (mm):</b>	
COMPRIMENTO	328
LARGURA	149,5
ALTURA	57,5
D. INTERNO	
D. EXTERNO	
ROSCA	
BICOS	

**FA4830S**

**BMW**



<b>OEM:</b>	
13721730946	
13721738462	
<b>EQUIVALÊNCIAS:</b>	
MANN	C25114
MAHLE	LX343
FRAM	CA5350
WEGA	FAP4830
TECFIL	
<b>MEDIDAS (mm):</b>	
COMPRIMENTO	244
LARGURA	178
ALTURA	58,5
D. INTERNO	
D. EXTERNO	
ROSCA	
BICOS	

**FA4833S**

**MB**



<b>OEM:</b>	
6040940004	
6040940104	
<b>EQUIVALÊNCIAS:</b>	
MANN	C30195
MAHLE	LX439
FRAM	CA5539
WEGA	FAP4833
TECFIL	
<b>MEDIDAS (mm):</b>	
COMPRIMENTO	294
LARGURA	228
ALTURA	57,5
D. INTERNO	
D. EXTERNO	
ROSCA	
BICOS	

**FA4837S**

**RENAULT**



<b>OEM:</b>	
7701037111	
7701032117	
<b>EQUIVALÊNCIAS:</b>	
MANN	C3377
MAHLE	LX541
FRAM	CA5554
WEGA	FAP4837
TECFIL	
<b>MEDIDAS (mm):</b>	
COMPRIMENTO	325
LARGURA	101
ALTURA	58
D. INTERNO	
D. EXTERNO	
ROSCA	
BICOS	

**RENAULT**

**FA4840S**



<b>OEM:</b>	
7701040285	
<b>EQUIVALÊNCIAS:</b>	
MANN	C2282
MAHLE	LX475
FRAM	CA5673
WEGA	FAP4840
TECFIL	
<b>MEDIDAS (mm):</b>	
COMPRIMENTO	214
LARGURA	140
ALTURA	58
D. INTERNO	
D. EXTERNO	
ROSCA	
BICOS	

**VOLVO**

**FA4841S**



<b>OEM:</b>	
9186262 9410944	
<b>EQUIVALÊNCIAS:</b>	
MANN	C35148
MAHLE	LX686
FRAM	CA5436
WEGA	FAP4841
TECFIL	
<b>MEDIDAS (mm):</b>	
COMPRIMENTO	350
LARGURA	184
ALTURA	49,5
D. INTERNO	
D. EXTERNO	
ROSCA	
BICOS	

**MB**

**FA4842S**

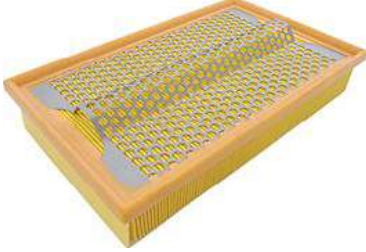

<b>OEM:</b>	
1110940004 A1110940004	
<b>EQUIVALÊNCIAS:</b>	
MANN	C29144
MAHLE	LX526
FRAM	CA5560
WEGA	FAP4842
TECFIL	
<b>MEDIDAS (mm):</b>	
COMPRIMENTO	280
LARGURA	170
ALTURA	57,5
D. INTERNO	
D. EXTERNO	
ROSCA	
BICOS	

**MB**

**FA4843S**



<b>OEM:</b>	
30946804	
<b>EQUIVALÊNCIAS:</b>	
MANN	C3484
MAHLE	LX617
FRAM	CA7337
WEGA	FAP4843
TECFIL	
<b>MEDIDAS (mm):</b>	
COMPRIMENTO	338
LARGURA	100
ALTURA	58,8
D. INTERNO	
D. EXTERNO	
ROSCA	
BICOS	

**MB**

**FA4844S**



<b>OEM:</b>	
0030947104	
<b>EQUIVALÊNCIAS:</b>	
MANN	C31144
MAHLE	LX438
FRAM	
WEGA	FAP4844
TECFIL	
<b>MEDIDAS (mm):</b>	
COMPRIMENTO	306
LARGURA	171
ALTURA	59
D. INTERNO	
D. EXTERNO	
ROSCA	
BICOS	

**VW**

**FA4848S**



<b>OEM:</b>	
74129620	
<b>EQUIVALÊNCIAS:</b>	
MANN	C29198
MAHLE	LX537
FRAM	CA8169
WEGA	FAP4848
TECFIL	
<b>MEDIDAS (mm):</b>	
COMPRIMENTO	276
LARGURA	218
ALTURA	64
D. INTERNO	
D. EXTERNO	
ROSCA	
BICOS	

**MB**

**FA4853S**



<b>OEM:</b>	
6040940504 6040940604	
<b>EQUIVALÊNCIAS:</b>	
MANN	C34175
MAHLE	LX517
FRAM	CA5782
WEGA	FAP4853
TECFIL	
<b>MEDIDAS (mm):</b>	
COMPRIMENTO	337
LARGURA	190
ALTURA	58
D. INTERNO	
D. EXTERNO	
ROSCA	
BICOS	

**AUDI**

**FA4854S**



<b>OEM:</b>	
077129620A 059129620A	
<b>EQUIVALÊNCIAS:</b>	
MANN	C28214/1
MAHLE	LX469/1
FRAM	CA8194
WEGA	FAP4854
TECFIL	
<b>MEDIDAS (mm):</b>	
COMPRIMENTO	286
LARGURA	264
ALTURA	58
D. INTERNO	
D. EXTERNO	
ROSCA	
BICOS	

**VOLVO**

**FA4855S**



<b>OEM:</b>	
9186361	
<b>EQUIVALÊNCIAS:</b>	
MANN	C35215
MAHLE	LX937
FRAM	CA8979
WEGA	FAP4855
TECFIL	
<b>MEDIDAS (mm):</b>	
COMPRIMENTO	354,5
LARGURA	214,5
ALTURA	58
D. INTERNO	
D. EXTERNO	
ROSCA	
BICOS	

**MB**

**FA4856S**



<b>OEM:</b>	
30947204	
<b>EQUIVALÊNCIAS:</b>	
MANN	C35157
MAHLE	LX472
FRAM	CA8070
WEGA	FAP4856
TECFIL	
<b>MEDIDAS (mm):</b>	
COMPRIMENTO	358
LARGURA	156
ALTURA	57,2
D. INTERNO	
D. EXTERNO	
ROSCA	
BICOS	



MB	FA4858S	OEM: 6040940104
		EQUIVALÊNCIAS:
		MANN C30195/2
		MAHLE LX439/1
		FRAM CA5948
WEGA FAP9119		
MEDIDAS (mm):	COMPRIMENTO 294	
LARGURA 228		
ALTURA 57,5		
D. INTERNO	D. EXTERNO	
ROSCA	BICOS	

MB	FA4859S	OEM: 1120940104
		EQUIVALÊNCIAS:
		MANN C32164
		MAHLE LX927
		FRAM CA9426
WEGA		
MEDIDAS (mm):	COMPRIMENTO 316	
LARGURA 190		
ALTURA 56		
D. INTERNO	D. EXTERNO	
ROSCA	BICOS	

SEAT	FA4863S	OEM: 6K0129620B
		EQUIVALÊNCIAS:
		MANN C37132
		MAHLE LX997
		FRAM CA8995
WEGA FAP4863		
MEDIDAS (mm):	COMPRIMENTO 368	
LARGURA 134		
ALTURA 58		
D. INTERNO	D. EXTERNO	
ROSCA	BICOS	

FORD	FA4866S	OEM: 1496814 1C159601AE
		EQUIVALÊNCIAS:
		MANN C28100
		MAHLE LX1596
		FRAM
WEGA FAP4867		
MEDIDAS (mm):	COMPRIMENTO 283	
LARGURA 180		
ALTURA 58		
D. INTERNO	D. EXTERNO	
ROSCA	BICOS	

MB	FA4869S	OEM: 1120940104
		EQUIVALÊNCIAS:
		MANN C32164
		MAHLE LX927
		FRAM CA9426
WEGA FAP4869		
MEDIDAS (mm):	COMPRIMENTO 314	
LARGURA 188		
ALTURA 57		
D. INTERNO	D. EXTERNO	
ROSCA	BICOS	

PEUGEOT / RENAULT	FA4871S	OEM: 8200104272 1654600QAL
		EQUIVALÊNCIAS:
		MANN C1733
		MAHLE LX1711
		FRAM CA9512
WEGA FAP4871		
MEDIDAS (mm):	COMPRIMENTO 186	
LARGURA 78		
ALTURA 58		
D. INTERNO	D. EXTERNO	
ROSCA	BICOS	

CITROËN / PEUGEOT	FA4873S	OEM: 1444EC 1444EF
		EQUIVALÊNCIAS:
		MANN C3485/1
		MAHLE LX1287
		FRAM CA9315
WEGA FAP4873		
MEDIDAS (mm):	COMPRIMENTO 335	
LARGURA 102		
ALTURA 59		
D. INTERNO	D. EXTERNO	
ROSCA	BICOS	

CITROËN / PEUGEOT	FA4873/1S	OEM: 1444EC 1444EF
		EQUIVALÊNCIAS:
		MANN C3485/1
		MAHLE LX1287
		FRAM CA9315
WEGA FAP4873		
MEDIDAS (mm):	COMPRIMENTO 335	
LARGURA 102		
ALTURA 70		
D. INTERNO	D. EXTERNO	
ROSCA	BICOS	

VOLVO	FA4874S	OEM: 8649788 9454647
		EQUIVALÊNCIAS:
		MANN C30189
		MAHLE LX700
		FRAM CA9073
WEGA FAP4874		
MEDIDAS (mm):	COMPRIMENTO 329	
LARGURA 216,5		
ALTURA 58		
D. INTERNO	D. EXTERNO	
ROSCA	BICOS	

MB	FA4875S	OEM: 1110940304
		EQUIVALÊNCIAS:
		MANN C52107
		MAHLE LX992
		FRAM CA9423
WEGA FAP4875		
MEDIDAS (mm):	COMPRIMENTO 520	
LARGURA 86		
ALTURA 58		
D. INTERNO	D. EXTERNO	
ROSCA	BICOS	

**FA4878S**

**BMW**



<b>OEM:</b>	
13717256008 13717505007	
<b>EQUIVALÊNCIAS:</b>	
MANN	C30153/1
MAHLE	LX778
FRAM	CA9634
WEGA	FAP9045
TECFIL	
<b>MEDIDAS (mm):</b>	
COMPRIMENTO	294,5
LARGURA	163
ALTURA	55
D. INTERNO	
D. EXTERNO	
ROSCA	
BICOS	

**FA4888S**

**CITROËN**



<b>OEM:</b>	
1444FK 1444PX	
<b>EQUIVALÊNCIAS:</b>	
MANN	C25118/1
MAHLE	LX1765
FRAM	CA10023
WEGA	FAP9013
TECFIL	ARL8109
<b>MEDIDAS (mm):</b>	
COMPRIMENTO	216
LARGURA	184
ALTURA	67
D. INTERNO	
D. EXTERNO	
ROSCA	
BICOS	

**FA4890/2S**

**FIAT**



<b>OEM:</b>	
93188723 93188725	
<b>EQUIVALÊNCIAS:</b>	
MANN	C21106
MAHLE	LX1846
FRAM	
WEGA	FAP2833
TECFIL	
<b>MEDIDAS (mm):</b>	
COMPRIMENTO	212
LARGURA	199
ALTURA	68
D. INTERNO	
D. EXTERNO	
ROSCA	
BICOS	

**FA4891S**

**CITROËN/PEUGEOT**



<b>OEM:</b>	
1444EL 1444CV	
<b>EQUIVALÊNCIAS:</b>	
MANN	C35110
MAHLE	LX1619
FRAM	CA9924
WEGA	FAP4891
TECFIL	
<b>MEDIDAS (mm):</b>	
COMPRIMENTO	357,5
LARGURA	151,5
ALTURA	59
D. INTERNO	
D. EXTERNO	
ROSCA	
BICOS	

**FA4892S**

**NISSAN/RENAULT**



<b>OEM:</b>	
7701064439 7701065774	
<b>EQUIVALÊNCIAS:</b>	
MANN	C3366/1
MAHLE	LX1655
FRAM	CA10602
WEGA	FAP4872/1
TECFIL	ARL5138
<b>MEDIDAS (mm):</b>	
COMPRIMENTO	361
LARGURA	81
ALTURA	58
D. INTERNO	
D. EXTERNO	
ROSCA	
BICOS	

**FA4895S**

**VOLVO**



<b>OEM:</b>	
8683561 1232496	
<b>EQUIVALÊNCIAS:</b>	
MANN	C28122
MAHLE	LX1572
FRAM	CA9694
WEGA	FAP9018
TECFIL	
<b>MEDIDAS (mm):</b>	
COMPRIMENTO	284
LARGURA	190
ALTURA	50
D. INTERNO	
D. EXTERNO	
ROSCA	
BICOS	

**FA5010S**

**MITSUBISHI**



<b>OEM:</b>	
CDPA0039 6223618M1	
<b>EQUIVALÊNCIAS:</b>	
MANN	C18360
MAHLE	
FRAM	CA10764
WEGA	JFA575
TECFIL	
<b>MEDIDAS (mm):</b>	
COMPRIMENTO	
LARGURA	
ALTURA	352
D. INTERNO	106
D. EXTERNO	172
ROSCA	
BICOS	

**FA5305S**

**RENAULT**



<b>OEM:</b>	
7700111834	
<b>EQUIVALÊNCIAS:</b>	
MANN	C24123/1
MAHLE	LX742
FRAM	CA10354
WEGA	
TECFIL	
<b>MEDIDAS (mm):</b>	
COMPRIMENTO	231
LARGURA	194
ALTURA	58
D. INTERNO	
D. EXTERNO	
ROSCA	
BICOS	

**FA5308S**

**RENAULT**



<b>OEM:</b>	
7701034705 1444K1	
<b>EQUIVALÊNCIAS:</b>	
MANN	C16113
MAHLE	LX329
FRAM	CA5308
WEGA	WR282
TECFIL	
<b>MEDIDAS (mm):</b>	
COMPRIMENTO	
LARGURA	
ALTURA	180
D. INTERNO	93
D. EXTERNO	154
ROSCA	
BICOS	

**FA5589S**

**NEW HOLLAND**



<b>OEM:</b>	
222421A1 6005011111	
<b>EQUIVALÊNCIAS:</b>	
MANN	C17337/2
MAHLE	LX1142
FRAM	CA5741
WEGA	
TECFIL	ARS8889
<b>MEDIDAS (mm):</b>	
COMPRIMENTO	
LARGURA	
ALTURA	355
D. INTERNO	90
D. EXTERNO	165
ROSCA	
BICOS	



**FA6003S**

**MB**



<b>OEM:</b>	
30948304 6900947004	
<b>EQUIVALÊNCIAS:</b>	
MANN	C32338/1
MAHLE	LX511/1
FRAM	CA5875
WEGA	FAP6003
TECFIL	ARL5310
<b>MEDIDAS (mm):</b>	
COMPRIMENTO	316
LARGURA	277
ALTURA	80
D. INTERNO	
D. EXTERNO	
ROSCA	
BICOS	

**FA6007S**

**AUDI**



<b>OEM:</b>	
06C133843	
<b>EQUIVALÊNCIAS:</b>	
MANN	C27192/1
MAHLE	LX819
FRAM	CA9409
WEGA	FAP6007
TECFIL	
<b>MEDIDAS (mm):</b>	
COMPRIMENTO	266,5
LARGURA	212,5
ALTURA	70
D. INTERNO	
D. EXTERNO	
ROSCA	
BICOS	

**FA6008S**

**CITROËN / PEUGEOT**



<b>OEM:</b>	
1444J4 1444R3	
<b>EQUIVALÊNCIAS:</b>	
MANN	C2159
MAHLE	LX645
FRAM	CA8674
WEGA	FAP6008
TECFIL	ARL5050
<b>MEDIDAS (mm):</b>	
COMPRIMENTO	205
LARGURA	169
ALTURA	78
D. INTERNO	
D. EXTERNO	
ROSCA	
BICOS	

**FA6009S**

**RENAULT**



<b>OEM:</b>	
7700865603 7700873365	
<b>EQUIVALÊNCIAS:</b>	
MANN	C26107
MAHLE	LX947
FRAM	CA9097
WEGA	FAP6009
TECFIL	
<b>MEDIDAS (mm):</b>	
COMPRIMENTO	258
LARGURA	143
ALTURA	70
D. INTERNO	
D. EXTERNO	
ROSCA	
BICOS	

**FA6010S**

**PEUGEOT**



<b>OEM:</b>	
1444FJ 9649765880	
<b>EQUIVALÊNCIAS:</b>	
MANN	C25126
MAHLE	LX1048
FRAM	CA9080
WEGA	FAP6010
TECFIL	ARL8108
<b>MEDIDAS (mm):</b>	
COMPRIMENTO	248
LARGURA	168
ALTURA	88
D. INTERNO	
D. EXTERNO	
ROSCA	
BICOS	

**FA6080S**

**CITROËN / FIAT**



<b>OEM:</b>	
1310636080 1365070080	
<b>EQUIVALÊNCIAS:</b>	
MANN	C17278
MAHLE	LX611
FRAM	CA9231
WEGA	WR316
TECFIL	ARS1013
<b>MEDIDAS (mm):</b>	
COMPRIMENTO	
LARGURA	
ALTURA	285
D. INTERNO	84
D. EXTERNO	163
ROSCA	
BICOS	

**FA7001S**

**CITROËN / PEUGEOT**



<b>OEM:</b>	
1444F6 1444F7	
<b>EQUIVALÊNCIAS:</b>	
MANN	C32123
MAHLE	LX744
FRAM	CA8963
WEGA	FAP9272
TECFIL	ART5052
<b>MEDIDAS (mm):</b>	
COMPRIMENTO	318
LARGURA	175
ALTURA	58
D. INTERNO	
D. EXTERNO	
ROSCA	
BICOS	

**FA7005S**

**VW / FORD**



<b>OEM:</b>	
6Y0129620 5Z0129620	
<b>EQUIVALÊNCIAS:</b>	
MANN	C2295/2
MAHLE	LX998
FRAM	CA9410
WEGA	FAP7007
TECFIL	ART6098
<b>MEDIDAS (mm):</b>	
COMPRIMENTO	210
LARGURA	123/218
ALTURA	56
D. INTERNO	
D. EXTERNO	
ROSCA	
BICOS	

**FA7006S**

**VW / SEAT**



<b>OEM:</b>	
5Z0129620A 6Q0129620	
<b>EQUIVALÊNCIAS:</b>	
MANN	C2295/3
MAHLE	LX708
FRAM	CA9431
WEGA	FAP7006
TECFIL	ART6097
<b>MEDIDAS (mm):</b>	
COMPRIMENTO	211
LARGURA	123/218
ALTURA	68
D. INTERNO	
D. EXTERNO	
ROSCA	
BICOS	

**FA7009S**

**RENAULT**



<b>OEM:</b>	
7700274216 7701047655	
<b>EQUIVALÊNCIAS:</b>	
MANN	C2672/1
MAHLE	LX994
FRAM	CA9074
WEGA	WR244
TECFIL	
<b>MEDIDAS (mm):</b>	
COMPRIMENTO	
LARGURA	
ALTURA	91
D. INTERNO	234
D. EXTERNO	296
ROSCA	
BICOS	

**FA7010S**

**CITROËN**



<b>OEM:</b>	
1444V3	
1444V2	
<b>EQUIVALÊNCIAS:</b>	
MANN	C1995
MAHLE	LX795
FRAM	CA9469
WEGA	FAP7010
TECFIL	
<b>MEDIDAS (mm):</b>	
COMPRIMENTO	188,5
LARGURA	117
ALTURA	70
D. INTERNO	
D. EXTERNO	
ROSCA	
BICOS	

**FA7013S**

**NISSAN / RENAULT**



<b>OEM:</b>	
8200166615	
8200371661	
<b>EQUIVALÊNCIAS:</b>	
MANN	C2538
MAHLE	LX957/3
FRAM	CA9784
WEGA	FAP7013
TECFIL	
<b>MEDIDAS (mm):</b>	
COMPRIMENTO	240
LARGURA	134/190
ALTURA	58
D. INTERNO	
D. EXTERNO	
ROSCA	
BICOS	

**FA7701S**

**RENAULT**



<b>OEM:</b>	
7701033713	
7700957336	
<b>EQUIVALÊNCIAS:</b>	
MANN	C18121
MAHLE	LX330
FRAM	CA5229
WEGA	WR274
TECFIL	AR7701
<b>MEDIDAS (mm):</b>	
COMPRIMENTO	
LARGURA	
ALTURA	127
D. INTERNO	89
D. EXTERNO	178
ROSCA	
BICOS	

**FA7990S**

**FORD**



<b>OEM:</b>	
YL5U9601AA	
<b>EQUIVALÊNCIAS:</b>	
MANN	C18263
MAHLE	LX1713
FRAM	CA9936
WEGA	WAP383
TECFIL	ARS7990
<b>MEDIDAS (mm):</b>	
COMPRIMENTO	
LARGURA	
ALTURA	292
D. INTERNO	91,5
D. EXTERNO	173
ROSCA	
BICOS	

**FA7991S**

**FORD**



<b>OEM:</b>	
2N1U9601CB	
<b>EQUIVALÊNCIAS:</b>	
MANN	C11102
MAHLE	LX2531
FRAM	CA9833
WEGA	WR252
TECFIL	ARS7991
<b>MEDIDAS (mm):</b>	
COMPRIMENTO	
LARGURA	
ALTURA	310,8
D. INTERNO	51,9
D. EXTERNO	105
ROSCA	
BICOS	

**FA7998S**

**FORD**



<b>OEM:</b>	
91TU9601AA	
BF6T9601AA	
<b>EQUIVALÊNCIAS:</b>	
MANN	C17308
MAHLE	LX910
FRAM	CA283A
WEGA	WAP285
TECFIL	AP7998
<b>MEDIDAS (mm):</b>	
COMPRIMENTO	
LARGURA	
ALTURA	392
D. INTERNO	106
D. EXTERNO	174
ROSCA	
BICOS	

**FA8233S**

**FORD**



<b>OEM:</b>	
F57X9601AA	
F57Z9601A	
<b>EQUIVALÊNCIAS:</b>	
MANN	C1761
MAHLE	LX1937
FRAM	CA7774
WEGA	FAP9001
TECFIL	AR1068
<b>MEDIDAS (mm):</b>	
COMPRIMENTO	
LARGURA	
ALTURA	205
D. INTERNO	
D. EXTERNO	176
ROSCA	
BICOS	

**FA8280S**

**AGRALE / IVECO**



<b>OEM:</b>	
93828280	
2001321001	
<b>EQUIVALÊNCIAS:</b>	
MANN	C18450/1
MAHLE	LX2532
FRAM	CA10221
WEGA	WR200/8
TECFIL	ARS8234
<b>MEDIDAS (mm):</b>	
COMPRIMENTO	
LARGURA	
ALTURA	423
D. INTERNO	104,5
D. EXTERNO	174
ROSCA	
BICOS	

**FA8299S**

**DODGE**



<b>OEM:</b>	
04891097AA	
<b>EQUIVALÊNCIAS:</b>	
MANN	MA1059
MAHLE	
FRAM	CA8805
WEGA	WR197
TECFIL	
<b>MEDIDAS (mm):</b>	
COMPRIMENTO	
LARGURA	
ALTURA	167
D. INTERNO	61,7
D. EXTERNO	144
ROSCA	
BICOS	

**FA8306S**

**SUZUKI**



<b>OEM:</b>	
13780B0J00	
<b>EQUIVALÊNCIAS:</b>	
MANN	
MAHLE	
FRAM	CA10633
WEGA	JFA885
TECFIL	
<b>MEDIDAS (mm):</b>	
COMPRIMENTO	283,8
LARGURA	136,9
ALTURA	44
D. INTERNO	
D. EXTERNO	
ROSCA	
BICOS	



**FA8401S**

**FORD**



<b>OEM:</b>	
E6AZ9601B 25097062	
<b>EQUIVALÊNCIAS:</b>	
MANN	LX2645
MAHLE	CA5058
FRAM	FAP8999
WEGA	FAP8999
TECFIL	ARL1069
<b>MEDIDAS (mm):</b>	
COMPRIMENTO	285
LARGURA	155
ALTURA	29
D. INTERNO	
D. EXTERNO	
ROSCA	
BICOS	

**FA8404S**

**FORD**



<b>OEM:</b>	
E7TZ9601B 12337451	
<b>EQUIVALÊNCIAS:</b>	
MANN	C3381
MAHLE	
FRAM	CA6366
WEGA	FAP3257
TECFIL	
<b>MEDIDAS (mm):</b>	
COMPRIMENTO	328
LARGURA	148
ALTURA	42
D. INTERNO	
D. EXTERNO	
ROSCA	
BICOS	

**FA8405S**

**CHEVROLET**



<b>OEM:</b>	
25098463 25098459	
<b>EQUIVALÊNCIAS:</b>	
MANN	C2970
MAHLE	LX964
FRAM	CA7421
WEGA	FAP3234
TECFIL	ARL8838
<b>MEDIDAS (mm):</b>	
COMPRIMENTO	292
LARGURA	153
ALTURA	42
D. INTERNO	
D. EXTERNO	
ROSCA	
BICOS	

**FA8409S**

**FORD**



<b>OEM:</b>	
F50X9601AB F50Y9601A	
<b>EQUIVALÊNCIAS:</b>	
MANN	
MAHLE	LX1933
FRAM	CA8039
WEGA	
TECFIL	
<b>MEDIDAS (mm):</b>	
COMPRIMENTO	
LARGURA	
ALTURA	202
D. INTERNO	
D. EXTERNO	206
ROSCA	
BICOS	

**FA8410S**

**FORD**



<b>OEM:</b>	
ZZP023603 1F7023603	
<b>EQUIVALÊNCIAS:</b>	
MANN	C23121/2
MAHLE	LX1095
FRAM	CA8243
WEGA	FAP9002
TECFIL	ARL9606
<b>MEDIDAS (mm):</b>	
COMPRIMENTO	222
LARGURA	193
ALTURA	56
D. INTERNO	
D. EXTERNO	
ROSCA	
BICOS	

**FA8416S**

**CHEVROLET**



<b>OEM:</b>	
25332443 25313348	
<b>EQUIVALÊNCIAS:</b>	
MANN	
MAHLE	
FRAM	CA8756
WEGA	FAP9056
TECFIL	
<b>MEDIDAS (mm):</b>	
COMPRIMENTO	313
LARGURA	247
ALTURA	59
D. INTERNO	
D. EXTERNO	
ROSCA	
BICOS	

**FA8437S**

**FORD**



<b>OEM:</b>	
F6DZ9601B F23Z9601B	
<b>EQUIVALÊNCIAS:</b>	
MANN	C1029
MAHLE	
FRAM	CA7365
WEGA	FAP2842
TECFIL	
<b>MEDIDAS (mm):</b>	
COMPRIMENTO	251
LARGURA	177
ALTURA	70
D. INTERNO	
D. EXTERNO	
ROSCA	
BICOS	

**FA8441S**

**FORD**



<b>OEM:</b>	
1L2Z9601AA	
<b>EQUIVALÊNCIAS:</b>	
MANN	
MAHLE	
FRAM	CA9332
WEGA	
TECFIL	
<b>MEDIDAS (mm):</b>	
COMPRIMENTO	292
LARGURA	179,8
ALTURA	58
D. INTERNO	
D. EXTERNO	
ROSCA	
BICOS	

**FA8458S**

**DODGE**



<b>OEM:</b>	
53032404AA	
<b>EQUIVALÊNCIAS:</b>	
MANN	MA1037
MAHLE	
FRAM	CA9401
WEGA	
TECFIL	
<b>MEDIDAS (mm):</b>	
COMPRIMENTO	350,7
LARGURA	239
ALTURA	51,3
D. INTERNO	
D. EXTERNO	
ROSCA	
BICOS	

**FA8466S**

**JAGUAR**



<b>OEM:</b>	
XR830418 XR88237	
<b>EQUIVALÊNCIAS:</b>	
MANN	C3270
MAHLE	LX942
FRAM	CA8956
WEGA	FAP9063
TECFIL	
<b>MEDIDAS (mm):</b>	
COMPRIMENTO	315
LARGURA	166
ALTURA	45
D. INTERNO	
D. EXTERNO	
ROSCA	
BICOS	

**FA8468S**

**VOLVO**



<b>OEM:</b>	
8649788	
9454647	
<b>EQUIVALÊNCIAS:</b>	
MANN	C30189
MAHLE	LX700
FRAM	CA9073
WEGA	FAP4874
TECFIL	
<b>MEDIDAS (mm):</b>	
COMPRIMENTO	329
LARGURA	216
ALTURA	58
D. INTERNO	
D. EXTERNO	
ROSCA	
BICOS	

**FA8471S**

**DODGE**



<b>OEM:</b>	
53032700AA	
53032700AB	
<b>EQUIVALÊNCIAS:</b>	
MANN	MA1071
MAHLE	
FRAM	CA9589
WEGA	FAP9010
TECFIL	
<b>MEDIDAS (mm):</b>	
COMPRIMENTO	278
LARGURA	252
ALTURA	48
D. INTERNO	
D. EXTERNO	
ROSCA	
BICOS	

**FA8494S**

**VOLVO**



<b>OEM:</b>	
8638600	
<b>EQUIVALÊNCIAS:</b>	
MANN	C33194
MAHLE	LX868
FRAM	CA9636
WEGA	FAP9019
TECFIL	
<b>MEDIDAS (mm):</b>	
COMPRIMENTO	330
LARGURA	216
ALTURA	58
D. INTERNO	
D. EXTERNO	
ROSCA	
BICOS	

**FA8499S**

**VOLVO**



<b>OEM:</b>	
91610337	
13363973	
<b>EQUIVALÊNCIAS:</b>	
MANN	C29122/1
MAHLE	LX443
FRAM	CA4568
WEGA	FAP3209
TECFIL	
<b>MEDIDAS (mm):</b>	
COMPRIMENTO	285
LARGURA	215
ALTURA	41
D. INTERNO	
D. EXTERNO	
ROSCA	
BICOS	

**FA8503S**

**FORD**



<b>OEM:</b>	
F4ZX9601AC	
F4ZZ9601A	
<b>EQUIVALÊNCIAS:</b>	
MANN	MA1051
MAHLE	
FRAM	CA7730
WEGA	WR253
TECFIL	
<b>MEDIDAS (mm):</b>	
COMPRIMENTO	
LARGURA	
ALTURA	200
D. INTERNO	
D. EXTERNO	117
ROSCA	
BICOS	

**FA8504S**

**FORD**



<b>OEM:</b>	
F67Z9601AA	
<b>EQUIVALÊNCIAS:</b>	
MANN	
MAHLE	
FRAM	CA8141
WEGA	WR199/7
TECFIL	
<b>MEDIDAS (mm):</b>	
COMPRIMENTO	
LARGURA	
ALTURA	149
D. INTERNO	
D. EXTERNO	174
ROSCA	
BICOS	

**FA8509S**

**FORD**



<b>OEM:</b>	
4L3Z9601BA	
4L329601BA	
<b>EQUIVALÊNCIAS:</b>	
MANN	
MAHLE	
FRAM	CA9687
WEGA	
TECFIL	
<b>MEDIDAS (mm):</b>	
COMPRIMENTO	277
LARGURA	208
ALTURA	34,5
D. INTERNO	
D. EXTERNO	
ROSCA	
BICOS	

**FA8512S**

**CHEVROLET**



<b>OEM:</b>	
92082656	
92068161	
<b>EQUIVALÊNCIAS:</b>	
MANN	
MAHLE	
FRAM	CA10538
WEGA	FAP9007
TECFIL	
<b>MEDIDAS (mm):</b>	
COMPRIMENTO	288
LARGURA	228
ALTURA	37
D. INTERNO	
D. EXTERNO	
ROSCA	
BICOS	

**FA8520S**

**BMW**



<b>OEM:</b>	
13721702907	
137211742201	
<b>EQUIVALÊNCIAS:</b>	
MANN	C29105
MAHLE	LX494
FRAM	CA8220
WEGA	FAP4820
TECFIL	
<b>MEDIDAS (mm):</b>	
COMPRIMENTO	281
LARGURA	149
ALTURA	57
D. INTERNO	
D. EXTERNO	
ROSCA	
BICOS	

**FA8523S**

**JAGUAR**



<b>OEM:</b>	
2W939601AC	
AJ82766	
<b>EQUIVALÊNCIAS:</b>	
MANN	C30115
MAHLE	LX1649
FRAM	CA9513
WEGA	FAP9062
TECFIL	
<b>MEDIDAS (mm):</b>	
COMPRIMENTO	296
LARGURA	171
ALTURA	57,5
D. INTERNO	
D. EXTERNO	
ROSCA	
BICOS	



**FA8524S**

**JAGUAR**



<b>OEM:</b>	
C2S11215 1X439601AA	
<b>EQUIVALÊNCIAS:</b>	
MANN	C38116
MAHLE	LX1249
FRAM	CA9708
WEGA	FAP9046
TECFIL	
<b>MEDIDAS (mm):</b>	
COMPRIMENTO	379,5
LARGURA	156
ALTURA	42
D. INTERNO	
D. EXTERNO	
ROSCA	
BICOS	

**FA8553S**

**AUDI**



<b>OEM:</b>	
4E0129620 4E0129620C	
<b>EQUIVALÊNCIAS:</b>	
MANN	C1652
MAHLE	LX1275
FRAM	
WEGA	WR211
TECFIL	
<b>MEDIDAS (mm):</b>	
COMPRIMENTO	
LARGURA	
ALTURA	184,5
D. INTERNO	89
D. EXTERNO	152
ROSCA	
BICOS	

**FA8588S**

**AUDI / PORSCHE**



<b>OEM:</b>	
7L0129620 PHE500021	
<b>EQUIVALÊNCIAS:</b>	
MANN	C39201
MAHLE	LX792
FRAM	CA236
WEGA	FAP9024
TECFIL	
<b>MEDIDAS (mm):</b>	
COMPRIMENTO	392
LARGURA	186
ALTURA	60,5
D. INTERNO	
D. EXTERNO	
ROSCA	
BICOS	

**FA8591S**

**FORD**



<b>OEM:</b>	
4R3Z9601AA 4R3U9601AB	
<b>EQUIVALÊNCIAS:</b>	
MANN	MA1096
MAHLE	
FRAM	CA9895
WEGA	FAP8997
TECFIL	
<b>MEDIDAS (mm):</b>	
COMPRIMENTO	254
LARGURA	234
ALTURA	46
D. INTERNO	
D. EXTERNO	
ROSCA	
BICOS	

**FA8619S**

**CHRYSLER**



<b>OEM:</b>	
04891691AA	
<b>EQUIVALÊNCIAS:</b>	
MANN	C2683
MAHLE	LX1661
FRAM	
WEGA	FAP3283
TECFIL	
<b>MEDIDAS (mm):</b>	
COMPRIMENTO	256
LARGURA	162
ALTURA	42
D. INTERNO	
D. EXTERNO	
ROSCA	
BICOS	

**FA8621S**

**FORD**



<b>OEM:</b>	
L51813Z40A 6E5Z9601EA	
<b>EQUIVALÊNCIAS:</b>	
MANN	C2278
MAHLE	LX2642
FRAM	CA10094
WEGA	FAP9004
TECFIL	ARL9602
<b>MEDIDAS (mm):</b>	
COMPRIMENTO	261
LARGURA	159
ALTURA	51
D. INTERNO	
D. EXTERNO	
ROSCA	
BICOS	

**FA8622S**

**FORD**



<b>OEM:</b>	
6E5Z9601GA 6E5Z96016A	
<b>EQUIVALÊNCIAS:</b>	
MANN	
MAHLE	LX2818
FRAM	CA10092
WEGA	FAP2841
TECFIL	
<b>MEDIDAS (mm):</b>	
COMPRIMENTO	213
LARGURA	160
ALTURA	50
D. INTERNO	
D. EXTERNO	
ROSCA	
BICOS	

**FA8630S**

**AUDI**



<b>OEM:</b>	
06F133843A	
<b>EQUIVALÊNCIAS:</b>	
MANN	C41110
MAHLE	LX1262
FRAM	CA10256
WEGA	FAP9025
TECFIL	
<b>MEDIDAS (mm):</b>	
COMPRIMENTO	407
LARGURA	172
ALTURA	35
D. INTERNO	
D. EXTERNO	
ROSCA	
BICOS	

**FA8641S**

**0**



<b>OEM:</b>	
6L2Z9601AA	
<b>EQUIVALÊNCIAS:</b>	
MANN	
MAHLE	
FRAM	
WEGA	
TECFIL	
<b>MEDIDAS (mm):</b>	
COMPRIMENTO	
LARGURA	
ALTURA	
D. INTERNO	
D. EXTERNO	
ROSCA	
BICOS	

**FA8646S**

**BMW**



<b>OEM:</b>	
13717542294	
<b>EQUIVALÊNCIAS:</b>	
MANN	C27114
MAHLE	LX1478
FRAM	CA10464
WEGA	
TECFIL	
<b>MEDIDAS (mm):</b>	
COMPRIMENTO	268
LARGURA	264
ALTURA	50
D. INTERNO	
D. EXTERNO	
ROSCA	
BICOS	

**FA8650S**

CHEVROLET



OEM:	
92066873	
EQUIVALÊNCIAS:	
MANN	
MAHLE	
FRAM	CA10591
WEGA	JFA886
TECFIL	
MEDIDAS (mm):	
COMPRIMENTO	331
LARGURA	240
ALTURA	51,2
D. INTERNO	
D. EXTERNO	
ROSCA	
BICOS	

**FA8652S**

FORD / LINCOLN



OEM:	
CY0113Z40A 7T4Z9601A	
EQUIVALÊNCIAS:	
MANN	MA1195
MAHLE	
FRAM	CA10242
WEGA	FAP9052
TECFIL	
MEDIDAS (mm):	
COMPRIMENTO	304
LARGURA	170,1
ALTURA	44,4
D. INTERNO	
D. EXTERNO	
ROSCA	
BICOS	

**FA8654S**

PONTIAC



OEM:	
15287103 15925738	
EQUIVALÊNCIAS:	
MANN	
MAHLE	
FRAM	CA10494
WEGA	
TECFIL	
MEDIDAS (mm):	
COMPRIMENTO	372
LARGURA	242
ALTURA	28
D. INTERNO	
D. EXTERNO	
ROSCA	
BICOS	

**FA8655S**

CHRYSLER



OEM:	
4891713AA 4891926AA	
EQUIVALÊNCIAS:	
MANN	C24100
MAHLE	
FRAM	
WEGA	FA989 / FAP9033
TECFIL	
MEDIDAS (mm):	
COMPRIMENTO	372
LARGURA	198
ALTURA	30
D. INTERNO	
D. EXTERNO	
ROSCA	
BICOS	

**FA8658S**

DODGE



OEM:	
53034051AB 53034249AA	
EQUIVALÊNCIAS:	
MANN	
MAHLE	
FRAM	CA10261
WEGA	FAP9011
TECFIL	
MEDIDAS (mm):	
COMPRIMENTO	278
LARGURA	252
ALTURA	111
D. INTERNO	
D. EXTERNO	
ROSCA	
BICOS	

**FA8674S**

AUDI



OEM:	
1K0129620D	
EQUIVALÊNCIAS:	
MANN	C35154
MAHLE	LX1211
FRAM	CA9711
WEGA	FAP6012
TECFIL	
MEDIDAS (mm):	
COMPRIMENTO	346
LARGURA	135
ALTURA	70
D. INTERNO	
D. EXTERNO	
ROSCA	
BICOS	

**FA8820S**

BMW



OEM:	
13717548888	
EQUIVALÊNCIAS:	
MANN	C36145
MAHLE	LX2036
FRAM	CA10675
WEGA	FAP4815
TECFIL	
MEDIDAS (mm):	
COMPRIMENTO	355
LARGURA	244
ALTURA	35
D. INTERNO	
D. EXTERNO	
ROSCA	
BICOS	

**FA8821S**

VOLVO



OEM:	
30745344	
EQUIVALÊNCIAS:	
MANN	
MAHLE	LX1593/2
FRAM	CA10500
WEGA	FAP9275
TECFIL	
MEDIDAS (mm):	
COMPRIMENTO	238
LARGURA	213
ALTURA	60
D. INTERNO	
D. EXTERNO	
ROSCA	
BICOS	

**FA8822S**

VOLVO



OEM:	
30636551	
EQUIVALÊNCIAS:	
MANN	C35177
MAHLE	LX1219
FRAM	CA10498
WEGA	FAP9276
TECFIL	
MEDIDAS (mm):	
COMPRIMENTO	202
LARGURA	231
ALTURA	60
D. INTERNO	
D. EXTERNO	
ROSCA	
BICOS	

**FA8823S**

VOLVO



OEM:	
30680293	
EQUIVALÊNCIAS:	
MANN	
MAHLE	LX1607/1
FRAM	CA10785
WEGA	FAP9279
TECFIL	
MEDIDAS (mm):	
COMPRIMENTO	222
LARGURA	220
ALTURA	68
D. INTERNO	
D. EXTERNO	
ROSCA	
BICOS	



**INFINITY**

**FA8839S**



<b>OEM:</b>	
16546JK20A	
<b>EQUIVALÊNCIAS:</b>	
MANN	
MAHLE	
FRAM	CA10544
WEGA	JFA109
TECFIL	
<b>MEDIDAS (mm):</b>	
COMPRIMENTO	180,8
LARGURA	167,4
ALTURA	33,5
D. INTERNO	
D. EXTERNO	
ROSCA	
BICOS	

**CHEVROLET**

**FA8860S**



<b>OEM:</b>	
92196275 A31173C	
<b>EQUIVALÊNCIAS:</b>	
MANN	
MAHLE	
FRAM	CA10690
WEGA	FAP9061
TECFIL	
<b>MEDIDAS (mm):</b>	
COMPRIMENTO	284
LARGURA	234
ALTURA	55,5
D. INTERNO	
D. EXTERNO	
ROSCA	
BICOS	

**AUDI**

**FA8906/1S**



<b>OEM:</b>	
4F0133843	
<b>EQUIVALÊNCIAS:</b>	
MANN	C17137/1X
MAHLE	
FRAM	CA10217
WEGA	FAP6011
TECFIL	
<b>MEDIDAS (mm):</b>	
COMPRIMENTO	
LARGURA	
ALTURA	175,5
D. INTERNO	45/94
D. EXTERNO	165
ROSCA	
BICOS	

**MB CAMINHÕES**

**FA9838S**



<b>OEM:</b>	
3740907104 3740907101	
<b>EQUIVALÊNCIAS:</b>	
MANN	C20457
MAHLE	LX1093
FRAM	CA9033
WEGA	WAP382
TECFIL	ARS9838
<b>MEDIDAS (mm):</b>	
COMPRIMENTO	
LARGURA	
ALTURA	382
D. INTERNO	95
D. EXTERNO	200
ROSCA	
BICOS	

**VW CAMINHÕES**

**FA9839S**



<b>OEM:</b>	
2S0129620 6345280306	
<b>EQUIVALÊNCIAS:</b>	
MANN	C27830
MAHLE	LX1716/1
FRAM	CA5626PU
WEGA	WAP103
TECFIL	ARS9839
<b>MEDIDAS (mm):</b>	
COMPRIMENTO	
LARGURA	
ALTURA	408
D. INTERNO	150
D. EXTERNO	263
ROSCA	
BICOS	

**SCANIA / VOLVO CAMINHÕES**

**FA9840S**



<b>OEM:</b>	
A0040943504 4760940004	
<b>EQUIVALÊNCIAS:</b>	
MANN	C271340
MAHLE	LX1313/1
FRAM	CA9747
WEGA	WAP181
TECFIL	ARS9840
<b>MEDIDAS (mm):</b>	
COMPRIMENTO	
LARGURA	
ALTURA	537
D. INTERNO	160
D. EXTERNO	265
ROSCA	
BICOS	

**BMW**

**FABR1S**



<b>OEM:</b>	
13717532754	
<b>EQUIVALÊNCIAS:</b>	
MANN	C1361
MAHLE	LX1651
FRAM	CA9951
WEGA	WR363
TECFIL	
<b>MEDIDAS (mm):</b>	
COMPRIMENTO	
LARGURA	
ALTURA	200
D. INTERNO	78
D. EXTERNO	143
ROSCA	
BICOS	

**BMW**

**FABR2S**



<b>OEM:</b>	
13717536006	
<b>EQUIVALÊNCIAS:</b>	
MANN	C18114
MAHLE	LX1035
FRAM	CA10239
WEGA	WR364
TECFIL	
<b>MEDIDAS (mm):</b>	
COMPRIMENTO	
LARGURA	
ALTURA	174
D. INTERNO	82
D. EXTERNO	173
ROSCA	
BICOS	

**MB**

**FABR3S**



<b>OEM:</b>	
2710940204	
<b>EQUIVALÊNCIAS:</b>	
MANN	C14114
MAHLE	LX1277
FRAM	CA9680
WEGA	WR365
TECFIL	
<b>MEDIDAS (mm):</b>	
COMPRIMENTO	
LARGURA	
ALTURA	252
D. INTERNO	70
D. EXTERNO	132
ROSCA	
BICOS	

**CHEVROLET**

**FABR10S**



<b>OEM:</b>	
90531003 01EFA133	
<b>EQUIVALÊNCIAS:</b>	
MANN	C30130
MAHLE	LX735
FRAM	CA5970
WEGA	FAP3268
TECFIL	ARL8840
<b>MEDIDAS (mm):</b>	
COMPRIMENTO	294
LARGURA	235
ALTURA	42
D. INTERNO	
D. EXTERNO	
ROSCA	
BICOS	

**FABR11S**

**FORD / VW**

<b>OEM:</b>	
271296201 27129620	
<b>EQUIVALÊNCIAS:</b>	
MANN	C26111
MAHLE	LX906
FRAM	CA5156
WEGA	FAP4034
TECFIL	ARL6090
<b>MEDIDAS (mm):</b>	
COMPRIMENTO	254
LARGURA	190
ALTURA	49,7
D. INTERNO	
D. EXTERNO	
ROSCA	
BICOS	

**FABR12S**

**CHEVROLET**

<b>OEM:</b>	
9129747 9110614	
<b>EQUIVALÊNCIAS:</b>	
MANN	C30125/1
MAHLE	LX999
FRAM	CA9590
WEGA	FAP3280
TECFIL	ARL8825
<b>MEDIDAS (mm):</b>	
COMPRIMENTO	290
LARGURA	206
ALTURA	42
D. INTERNO	
D. EXTERNO	
ROSCA	
BICOS	

**FABR13S**

**AUDI / VW**

<b>OEM:</b>	
1J0129620 1J0129620	
<b>EQUIVALÊNCIAS:</b>	
MANN	C37153
MAHLE	LX684
FRAM	CA5827
WEGA	FAP4045
TECFIL	ARL6093
<b>MEDIDAS (mm):</b>	
COMPRIMENTO	362
LARGURA	185
ALTURA	50
D. INTERNO	
D. EXTERNO	
ROSCA	
BICOS	

**FABR14S**

**NISSAN / RENAULT**

<b>OEM:</b>	
7701045724	
<b>EQUIVALÊNCIAS:</b>	
MANN	C1858/1
MAHLE	LX773
FRAM	CA8964
WEGA	FAP9273
TECFIL	ART5051
<b>MEDIDAS (mm):</b>	
COMPRIMENTO	176
LARGURA	97/138
ALTURA	78
D. INTERNO	
D. EXTERNO	
ROSCA	
BICOS	

**FABR15S**

**VW**

<b>OEM:</b>	
07K129620	
<b>EQUIVALÊNCIAS:</b>	
MANN	C43102
MAHLE	LX2093
FRAM	CA10085
WEGA	FAP6012/2
TECFIL	ARL6099
<b>MEDIDAS (mm):</b>	
COMPRIMENTO	430
LARGURA	130
ALTURA	38
D. INTERNO	
D. EXTERNO	
ROSCA	
BICOS	

**FABR16S**

**RENAULT**

<b>OEM:</b>	
7701039857 7701043709	
<b>EQUIVALÊNCIAS:</b>	
MANN	C1145/5
MAHLE	LX646
FRAM	CA8774
WEGA	WR349
TECFIL	AR7704
<b>MEDIDAS (mm):</b>	
COMPRIMENTO	
LARGURA	
ALTURA	180
D. INTERNO	72
D. EXTERNO	107
ROSCA	
BICOS	

**FABR17S**

**FORD / VW**

<b>OEM:</b>	
56129620 551129620	
<b>EQUIVALÊNCIAS:</b>	
MANN	C2852/2
MAHLE	LX208/1
FRAM	CA3333A
WEGA	WR201
TECFIL	AR9620
<b>MEDIDAS (mm):</b>	
COMPRIMENTO	
LARGURA	
ALTURA	61
D. INTERNO	221
D. EXTERNO	279
ROSCA	
BICOS	

**FABR18S**

**RENAULT**

<b>OEM:</b>	
1654600QAD 8200505566	
<b>EQUIVALÊNCIAS:</b>	
MANN	C29168
MAHLE	LX1656
FRAM	CA9991
WEGA	FAP3271/3
TECFIL	ARL5139
<b>MEDIDAS (mm):</b>	
COMPRIMENTO	285
LARGURA	249
ALTURA	65
D. INTERNO	
D. EXTERNO	
ROSCA	
BICOS	

**FABR19S**

**FIAT**

<b>OEM:</b>	
51854598	
<b>EQUIVALÊNCIAS:</b>	
MANN	C29003
MAHLE	LX3115
FRAM	
WEGA	FAP9054
TECFIL	ARL4152
<b>MEDIDAS (mm):</b>	
COMPRIMENTO	283,4
LARGURA	109
ALTURA	70,2
D. INTERNO	
D. EXTERNO	
ROSCA	
BICOS	

**FABR20S**

**FIAT**

<b>OEM:</b>	
51857956 52104113	
<b>EQUIVALÊNCIAS:</b>	
MANN	C37001
MAHLE	
FRAM	CA11112
WEGA	FAP9121
TECFIL	ARL4154
<b>MEDIDAS (mm):</b>	
COMPRIMENTO	356
LARGURA	208
ALTURA	51
D. INTERNO	
D. EXTERNO	
ROSCA	
BICOS	



FIAT	<b>FABR22S</b>	OEM: 55208286 46783544
		EQUIVALÊNCIAS:
		MANN C3092 MAHLE LX2643 FRAM CA10131 WEGA FAP9015 TECFIL ARL4151
		MEDIDAS (mm):
		COMPRIMENTO 299 LARGURA 193 ALTURA 37,5 D. INTERNO D. EXTERNO ROSCA BICOS

FIAT	<b>FABR23S</b>	OEM: 55199862
		EQUIVALÊNCIAS:
		MANN C22113 MAHLE LX2644 FRAM CA10130 WEGA FAP9014 TECFIL
		MEDIDAS (mm):
		COMPRIMENTO 211 LARGURA 202 ALTURA 57 D. INTERNO D. EXTERNO ROSCA BICOS

FORD	<b>FABR24S</b>	OEM: 9N159601AA
		EQUIVALÊNCIAS:
		MANN MAHLE FRAM CA10293 WEGA TECFIL
		MEDIDAS (mm):
		COMPRIMENTO 266 LARGURA 189 ALTURA 46 D. INTERNO D. EXTERNO ROSCA BICOS

PEUGEOT	<b>FABR25S</b>	OEM: 1444SP
		EQUIVALÊNCIAS:
		MANN C36005 MAHLE FRAM CA10227 WEGA FAP6000 TECFIL ARL5055
		MEDIDAS (mm):
		COMPRIMENTO 354 LARGURA 102 ALTURA 70 D. INTERNO D. EXTERNO ROSCA BICOS

CHEVROLET	<b>FABR26S</b>	OEM: 90411732 90486296
		EQUIVALÊNCIAS:
		MANN C2256 MAHLE LX523 FRAM CA5496 WEGA FAP2827 TECFIL ARL8832
		MEDIDAS (mm):
		COMPRIMENTO 204 LARGURA 167 ALTURA 37 D. INTERNO D. EXTERNO ROSCA BICOS

FIAT	<b>FABR27S</b>	OEM: 46420988 7082141
		EQUIVALÊNCIAS:
		MANN C2585 MAHLE LX908 FRAM CA5627 WEGA FAP2831 TECFIL ARL4150
		MEDIDAS (mm):
		COMPRIMENTO 251 LARGURA 195 ALTURA 36 D. INTERNO D. EXTERNO ROSCA BICOS

FORD / MAZDA	<b>FABR28S</b>	OEM: 98BF9601AA 96FB9601BA
		EQUIVALÊNCIAS:
		MANN C2677 MAHLE LX687 FRAM CA5682 WEGA FAP2832 TECFIL ARL9603
		MEDIDAS (mm):
		COMPRIMENTO 257 LARGURA 177 ALTURA 37 D. INTERNO D. EXTERNO ROSCA BICOS

VW	<b>FABR29S</b>	OEM: 036129620D 036129620F
		EQUIVALÊNCIAS:
		MANN C2990 MAHLE LX977 FRAM CA9519 WEGA FAP3287 TECFIL ARL6095
		MEDIDAS (mm):
		COMPRIMENTO 287 LARGURA 189 ALTURA 42 D. INTERNO D. EXTERNO ROSCA BICOS

FORD	<b>FABR30S</b>	OEM: XS5X9601DA
		EQUIVALÊNCIAS:
		MANN C2693 MAHLE LX1312 FRAM CA8736 WEGA FAP2840 TECFIL ARL9605
		MEDIDAS (mm):
		COMPRIMENTO 255 LARGURA 218 ALTURA 46 D. INTERNO D. EXTERNO ROSCA BICOS

CHEVROLET	<b>FABR31S</b>	OEM: 93260511
		EQUIVALÊNCIAS:
		MANN C1944 MAHLE LX1315 FRAM CA5981 WEGA FAP3289 TECFIL ARL8834
		MEDIDAS (mm):
		COMPRIMENTO 188 LARGURA 134 ALTURA 42 D. INTERNO D. EXTERNO ROSCA BICOS

**FABR32S**

FIAT



<b>OEM:</b>	
77229360	
<b>EQUIVALÊNCIAS:</b>	
MANN	C2496
MAHLE	LX907
FRAM	CA5325
WEGA	FAP4033
TECFIL	ARL4147
<b>MEDIDAS (mm):</b>	
COMPRIMENTO	243
LARGURA	182
ALTURA	44
D. INTERNO	
D. EXTERNO	
ROSCA	
BICOS	

**FABR34S**

VW



<b>OEM:</b>	
377129620	
<b>EQUIVALÊNCIAS:</b>	
MANN	C29108
MAHLE	LX909
FRAM	CA5513
WEGA	FAP4049
TECFIL	ARL6091
<b>MEDIDAS (mm):</b>	
COMPRIMENTO	288
LARGURA	164
ALTURA	48
D. INTERNO	
D. EXTERNO	
ROSCA	
BICOS	

**FABR35S**

VW



<b>OEM:</b>	
30129620 030129620D	
<b>EQUIVALÊNCIAS:</b>	
MANN	C2969
MAHLE	LX1779
FRAM	CA9290
WEGA	FAP2214
TECFIL	ARL6096
<b>MEDIDAS (mm):</b>	
COMPRIMENTO	276
LARGURA	188
ALTURA	29
D. INTERNO	
D. EXTERNO	
ROSCA	
BICOS	

**FABR36S**

CHEVROLET



<b>OEM:</b>	
90322262	
<b>EQUIVALÊNCIAS:</b>	
MANN	C2991/1
MAHLE	LX414
FRAM	CA4567
WEGA	FAP3226
TECFIL	ARL8836
<b>MEDIDAS (mm):</b>	
COMPRIMENTO	285
LARGURA	184
ALTURA	42
D. INTERNO	
D. EXTERNO	
ROSCA	
BICOS	

**FABR37S**

AUDI / VW



<b>OEM:</b>	
131129620 859129620	
<b>EQUIVALÊNCIAS:</b>	
MANN	C31152/1
MAHLE	LX296
FRAM	CA5301
WEGA	FAP4816
TECFIL	
<b>MEDIDAS (mm):</b>	
COMPRIMENTO	308
LARGURA	184
ALTURA	57
D. INTERNO	
D. EXTERNO	
ROSCA	
BICOS	

**FABR38S**

MINI



<b>OEM:</b>	
13717534825 1444RK	
<b>EQUIVALÊNCIAS:</b>	
MANN	C5082
MAHLE	LX1969
FRAM	CA10418
WEGA	FAP9012
TECFIL	
<b>MEDIDAS (mm):</b>	
COMPRIMENTO	493
LARGURA	84
ALTURA	58
D. INTERNO	
D. EXTERNO	
ROSCA	
BICOS	

**FABR39S**

BMW



<b>OEM:</b>	
13717542545	
<b>EQUIVALÊNCIAS:</b>	
MANN	C29132
MAHLE	LX1250
FRAM	
WEGA	FAP9031
TECFIL	
<b>MEDIDAS (mm):</b>	
COMPRIMENTO	285
LARGURA	227
ALTURA	47
D. INTERNO	
D. EXTERNO	
ROSCA	
BICOS	

**FABR40S**

VOLVO



<b>OEM:</b>	
6M5V9601AA 30637444	
<b>EQUIVALÊNCIAS:</b>	
MANN	C24137/1
MAHLE	LX1605
FRAM	CA10253
WEGA	FAP9035
TECFIL	
<b>MEDIDAS (mm):</b>	
COMPRIMENTO	234
LARGURA	206
ALTURA	62
D. INTERNO	
D. EXTERNO	
ROSCA	
BICOS	

**FABR41/2S**

MB



<b>OEM:</b>	
1310636080 6420940404	
<b>EQUIVALÊNCIAS:</b>	
MANN	C270002
MAHLE	LX1850/S
FRAM	CA10662
WEGA	FAP9036/2
TECFIL	
<b>MEDIDAS (mm):</b>	
COMPRIMENTO	tro1:274 filtro2:250
LARGURA	tro1:144 filtro2:175
ALTURA	35,5
D. INTERNO	
D. EXTERNO	
ROSCA	
BICOS	

**FABR42S**

VW



<b>OEM:</b>	
036129620C 032129620C	
<b>EQUIVALÊNCIAS:</b>	
MANN	C4287
MAHLE	LX571/1
FRAM	CA5898
WEGA	FAP9120
TECFIL	
<b>MEDIDAS (mm):</b>	
COMPRIMENTO	418
LARGURA	188
ALTURA	35
D. INTERNO	
D. EXTERNO	
ROSCA	
BICOS	



**FABR43S**

**CHEVROLET**



<b>OEM:</b>	
22676970	
<b>EQUIVALÊNCIAS:</b>	
MANN	
MAHLE	
FRAM	CA9492
WEGA	JFAW10
TECFIL	
<b>MEDIDAS (mm):</b>	
COMPRIMENTO	280
LARGURA	232
ALTURA	36
D. INTERNO	
D. EXTERNO	
ROSCA	
BICOS	

**FABR44S**

**LAND ROVER**



<b>OEM:</b>	
PHE500060	
<b>EQUIVALÊNCIAS:</b>	
MANN	C25122
MAHLE	LX2031
FRAM	CA10615
WEGA	FAP4868
TECFIL	
<b>MEDIDAS (mm):</b>	
COMPRIMENTO	247
LARGURA	197
ALTURA	68
D. INTERNO	
D. EXTERNO	
ROSCA	
BICOS	

**FABR45S**

**FORD / VOLVO**



<b>OEM:</b>	
7M519601AC	
<b>EQUIVALÊNCIAS:</b>	
MANN	C16134/1
MAHLE	LX1780/3
FRAM	CA10521
WEGA	WR192
TECFIL	ARS5196
<b>MEDIDAS (mm):</b>	
COMPRIMENTO	
LARGURA	
ALTURA	211
D. INTERNO	67
D. EXTERNO	157
ROSCA	
BICOS	

**FABR46S**

**CITROËN / MINI / PEUGEOT**



<b>OEM:</b>	
13717568728	
<b>EQUIVALÊNCIAS:</b>	
MANN	C36003
MAHLE	LX2033
FRAM	CA11096
WEGA	FAP6013
TECFIL	
<b>MEDIDAS (mm):</b>	
COMPRIMENTO	360
LARGURA	145
ALTURA	42
D. INTERNO	
D. EXTERNO	
ROSCA	
BICOS	

**FABR47S**

**SEA DOO**



<b>OEM:</b>	
4227087	
<b>EQUIVALÊNCIAS:</b>	
MANN	C2147
MAHLE	LX573
FRAM	CA3559
WEGA	FAP3275
TECFIL	
<b>MEDIDAS (mm):</b>	
COMPRIMENTO	300
LARGURA	185
ALTURA	58
D. INTERNO	
D. EXTERNO	
ROSCA	
BICOS	

**FABR48S**

**CHEVROLET**



<b>OEM:</b>	
25062055 90499582	
<b>EQUIVALÊNCIAS:</b>	
MANN	C34116/1
MAHLE	LX614
FRAM	CA5680
WEGA	FAP3262
TECFIL	ARL8839
<b>MEDIDAS (mm):</b>	
COMPRIMENTO	340
LARGURA	206
ALTURA	42
D. INTERNO	
D. EXTERNO	
ROSCA	
BICOS	

**FABR49S**

**CHEVROLET**



<b>OEM:</b>	
96815102 96628890	
<b>EQUIVALÊNCIAS:</b>	
MANN	
MAHLE	LX3018
FRAM	CA10115
WEGA	JFAW09
TECFIL	ART8826
<b>MEDIDAS (mm):</b>	
COMPRIMENTO	280
LARGURA	220
ALTURA	56
D. INTERNO	
D. EXTERNO	
ROSCA	
BICOS	

**FABR50S**

**AUDI / VW**



<b>OEM:</b>	
3C0129620 1F0129620	
<b>EQUIVALÊNCIAS:</b>	
MANN	C14130
MAHLE	LX1566
FRAM	CA9800
WEGA	WR196
TECFIL	
<b>MEDIDAS (mm):</b>	
COMPRIMENTO	
LARGURA	
ALTURA	221
D. INTERNO	72
D. EXTERNO	137
ROSCA	
BICOS	

**FABR51S**

**MB CAMINHÕES**



<b>OEM:</b>	
0010945304 3440947104	
<b>EQUIVALÊNCIAS:</b>	
MANN	C20325/2
MAHLE	LX265
FRAM	CA3291
WEGA	WAP163
TECFIL	AP9834
<b>MEDIDAS (mm):</b>	
COMPRIMENTO	
LARGURA	
ALTURA	378
D. INTERNO	103
D. EXTERNO	198
ROSCA	
BICOS	

**FABR52S**

**FORD**



<b>OEM:</b>	
BE8Z-9601-A AE81961AA	
<b>EQUIVALÊNCIAS:</b>	
MANN	C20002
MAHLE	LX3304
FRAM	CA10653
WEGA	FAP9286
TECFIL	ART9613
<b>MEDIDAS (mm):</b>	
COMPRIMENTO	195
LARGURA	165
ALTURA	60
D. INTERNO	
D. EXTERNO	
ROSCA	
BICOS	

**FABR54S**

**VW**



<b>OEM:</b>	
2H0129620A 2H0129620B	
<b>EQUIVALÊNCIAS:</b>	
MANN	C31003/1
MAHLE	LX3138
FRAM	CA10697
WEGA	FAP4046/1
TECFIL	ARL6070
<b>MEDIDAS (mm):</b>	
COMPRIMENTO	310
LARGURA	258
ALTURA	72
D. INTERNO	
D. EXTERNO	
ROSCA	
BICOS	

**FABR55S**

**LIFAN**



<b>OEM:</b>	
F1109160 11916	
<b>EQUIVALÊNCIAS:</b>	
MANN	
MAHLE	
FRAM	
WEGA	JFAL00
TECFIL	
<b>MEDIDAS (mm):</b>	
COMPRIMENTO	255
LARGURA	165
ALTURA	50
D. INTERNO	
D. EXTERNO	
ROSCA	
BICOS	

**FABR56S**

**CHANA / CN AUTO / EFFA**



<b>OEM:</b>	
HFJ1109130DB HFJ11913DB	
<b>EQUIVALÊNCIAS:</b>	
MANN	
MAHLE	
FRAM	
WEGA	JFAF31
TECFIL	
<b>MEDIDAS (mm):</b>	
COMPRIMENTO	180
LARGURA	155
ALTURA	55
D. INTERNO	
D. EXTERNO	
ROSCA	
BICOS	

**FABR57S**

**EFFA**



<b>OEM:</b>	
1378075FCO 7988433531	
<b>EQUIVALÊNCIAS:</b>	
MANN	
MAHLE	
FRAM	
WEGA	JFAF30
TECFIL	
<b>MEDIDAS (mm):</b>	
COMPRIMENTO	240
LARGURA	140
ALTURA	40
D. INTERNO	
D. EXTERNO	
ROSCA	
BICOS	

**FABR58S**

**FIAT**



<b>OEM:</b>	
51874053 51793172	
<b>EQUIVALÊNCIAS:</b>	
MANN	C14004
MAHLE	LX2088
FRAM	
WEGA	
TECFIL	
<b>MEDIDAS (mm):</b>	
COMPRIMENTO	
LARGURA	
ALTURA	345
D. INTERNO	50
D. EXTERNO	163
ROSCA	
BICOS	

**FABR59S**

**RENAULT**



<b>OEM:</b>	
5001847123 51847123	
<b>EQUIVALÊNCIAS:</b>	
MANN	C29168
MAHLE	LX1656
FRAM	CA9991
WEGA	FAP3271/2
TECFIL	
<b>MEDIDAS (mm):</b>	
COMPRIMENTO	316
LARGURA	261
ALTURA	57
D. INTERNO	
D. EXTERNO	
ROSCA	
BICOS	

**FABR60S**

**RENAULT**



<b>OEM:</b>	
7701071327 8200820869	
<b>EQUIVALÊNCIAS:</b>	
MANN	C2030
MAHLE	LX2916
FRAM	CA10760
WEGA	FAP9284
TECFIL	
<b>MEDIDAS (mm):</b>	
COMPRIMENTO	207
LARGURA	193
ALTURA	58
D. INTERNO	
D. EXTERNO	
ROSCA	
BICOS	

**FABR61S**

**HYUNDAI**



<b>OEM:</b>	
28113-1R100	
<b>EQUIVALÊNCIAS:</b>	
MANN	
MAHLE	LX2916
FRAM	CA11206
WEGA	JFAH27
TECFIL	
<b>MEDIDAS (mm):</b>	
COMPRIMENTO	257
LARGURA	146
ALTURA	54
D. INTERNO	
D. EXTERNO	
ROSCA	
BICOS	

**FABR62S**

**HYUNDAI / KIA**



<b>OEM:</b>	
281133S100 281133S1	
<b>EQUIVALÊNCIAS:</b>	
MANN	
MAHLE	
FRAM	
WEGA	JFAH25
TECFIL	
<b>MEDIDAS (mm):</b>	
COMPRIMENTO	276
LARGURA	227
ALTURA	42
D. INTERNO	
D. EXTERNO	
ROSCA	
BICOS	

**FABR64S**

**FORD**



<b>OEM:</b>	
2N1U9601AE 2NU9601AE	
<b>EQUIVALÊNCIAS:</b>	
MANN	C4280
MAHLE	LX1589
FRAM	CA9510
WEGA	FAP9008
TECFIL	ARL9609
<b>MEDIDAS (mm):</b>	
COMPRIMENTO	413
LARGURA	151
ALTURA	40
D. INTERNO	
D. EXTERNO	
ROSCA	
BICOS	



NISSAN	<b>FABR65S</b>	OEM: 165463AWA	
		EQUIVALÊNCIAS:	
		MANN	
		MAHLE	
		FRAM	JFA135
WEGA			
TECFIL			
MEDIDAS (mm):			
COMPRIMENTO	230		
LARGURA	117		
ALTURA	34		
D. INTERNO			
D. EXTERNO			
ROSCA			
BICOS			

CHEVROLET	<b>FABR66S</b>	OEM: 969599 96950990	
		EQUIVALÊNCIAS:	
		MANN	
		MAHLE	LX1997
		FRAM	
WEGA		FAP3269	
TECFIL		ARL8829	
MEDIDAS (mm):			
COMPRIMENTO	240		
LARGURA	172		
ALTURA	50		
D. INTERNO			
D. EXTERNO			
ROSCA			
BICOS			

AUDI	<b>FABR67S</b>	OEM: 8KO133843E 8R133843C	
		EQUIVALÊNCIAS:	
		MANN	C32130
		MAHLE	LX2046
		FRAM	CA10522
WEGA		FAP9053	
TECFIL			
MEDIDAS (mm):			
COMPRIMENTO	321		
LARGURA	128		
ALTURA	63		
D. INTERNO			
D. EXTERNO			
ROSCA			
BICOS			

CHEVROLET	<b>FABR68S</b>	OEM: 941651 941652	
		EQUIVALÊNCIAS:	
		MANN	C3167/1
		MAHLE	LX390
		FRAM	CA5400
WEGA		FAP1701	
TECFIL			
MEDIDAS (mm):			
COMPRIMENTO	310		
LARGURA	230		
ALTURA	27		
D. INTERNO			
D. EXTERNO			
ROSCA			
BICOS			

FIAT	<b>FABR69S</b>	OEM: 7712505	
		EQUIVALÊNCIAS:	
		MANN	C2664
		MAHLE	LX589
		FRAM	CA5495
WEGA		FAP4035	
TECFIL		ARL2505	
MEDIDAS (mm):			
COMPRIMENTO	257		
LARGURA	124		
ALTURA	47		
D. INTERNO			
D. EXTERNO			
ROSCA			
BICOS			

FIAT	<b>FABR70S</b>	OEM: 51773404	
		EQUIVALÊNCIAS:	
		MANN	C3273
		MAHLE	LX2087
		FRAM	CA10334
WEGA		FAP5307	
TECFIL			
MEDIDAS (mm):			
COMPRIMENTO	318		
LARGURA	152		
ALTURA	33		
D. INTERNO			
D. EXTERNO			
ROSCA			
BICOS			

CITROËN / PEUGEOT	<b>FABR71S</b>	OEM: 1444F2 1444J7	
		EQUIVALÊNCIAS:	
		MANN	C1184
		MAHLE	LX502
		FRAM	CA5331
WEGA		WR314	
TECFIL			
MEDIDAS (mm):			
COMPRIMENTO			
LARGURA			
ALTURA	243		
D. INTERNO	73		
D. EXTERNO	114		
ROSCA			
BICOS			

CADILLAC	<b>FABR72S</b>	OEM: 15875795	
		EQUIVALÊNCIAS:	
		MANN	
		MAHLE	
		FRAM	CA10626
WEGA		FAP9060	
TECFIL			
MEDIDAS (mm):			
COMPRIMENTO	285		
LARGURA	237		
ALTURA	56		
D. INTERNO			
D. EXTERNO			
ROSCA			
BICOS			

BMW	<b>FABR73S</b>	OEM: 13717548897	
		EQUIVALÊNCIAS:	
		MANN	C3090
		MAHLE	LX 2097
		FRAM	
WEGA		FAP9281	
TECFIL			
MEDIDAS (mm):			
COMPRIMENTO	295/171		
LARGURA	230/75		
ALTURA	38		
D. INTERNO			
D. EXTERNO			
ROSCA			
BICOS			

FORD / LINCOLN	<b>FABR74S</b>	OEM: 7C3Z9601A	
		EQUIVALÊNCIAS:	
		MANN	
		MAHLE	
		FRAM	CA10262
WEGA		FAP8995	
TECFIL			
MEDIDAS (mm):			
COMPRIMENTO	265		
LARGURA	250		
ALTURA	67		
D. INTERNO			
D. EXTERNO			
ROSCA			
BICOS			

**FABR76S**

**LAND ROVER**



<b>OEM:</b>	
PHE000050	
13717501239	
<b>EQUIVALÊNCIAS:</b>	
MANN	C18161
MAHLE	LX1460
FRAM	
WEGA	WR325
TECFIL	
<b>MEDIDAS (mm):</b>	
COMPRIMENTO	
LARGURA	
ALTURA	238
D. INTERNO	112
D. EXTERNO	179
ROSCA	
BICOS	

**FABR77S**

**MINI**



<b>OEM:</b>	
13727529261	
1372752926102	
<b>EQUIVALÊNCIAS:</b>	
MANN	C2245
MAHLE	LX1213
FRAM	CA10164
WEGA	FAP9009
TECFIL	
<b>MEDIDAS (mm):</b>	
COMPRIMENTO	218
LARGURA	165
ALTURA	46
D. INTERNO	
D. EXTERNO	
ROSCA	
BICOS	

**FABR78S**

**CHEVROLET**



<b>OEM:</b>	
94771925	
<b>EQUIVALÊNCIAS:</b>	
MANN	
MAHLE	
FRAM	CA11077
WEGA	WR295
TECFIL	ARS2870
<b>MEDIDAS (mm):</b>	
COMPRIMENTO	
LARGURA	
ALTURA	269
D. INTERNO	88
D. EXTERNO	160
ROSCA	
BICOS	

**FABR79S**

**HONDA**



<b>OEM:</b>	
17220R1AA01	
<b>EQUIVALÊNCIAS:</b>	
MANN	
MAHLE	
FRAM	
WEGA	JFA438
TECFIL	
<b>MEDIDAS (mm):</b>	
COMPRIMENTO	245
LARGURA	186
ALTURA	47
D. INTERNO	
D. EXTERNO	
ROSCA	
BICOS	

**FABR80S**

**CHEVROLET**



<b>OEM:</b>	
S111109111	
5111109111	
<b>EQUIVALÊNCIAS:</b>	
MANN	
MAHLE	
FRAM	
WEGA	JFAF02
TECFIL	
<b>MEDIDAS (mm):</b>	
COMPRIMENTO	198
LARGURA	189
ALTURA	33
D. INTERNO	
D. EXTERNO	
ROSCA	
BICOS	

**FABR81S**

**RENAULT**



<b>OEM:</b>	
8200820859	
165465434R	
<b>EQUIVALÊNCIAS:</b>	
MANN	CA25115
MAHLE	LX1748
FRAM	C10651
WEGA	FAP9283
TECFIL	
<b>MEDIDAS (mm):</b>	
COMPRIMENTO	247
LARGURA	135/192
ALTURA	66
D. INTERNO	
D. EXTERNO	
ROSCA	
BICOS	

**FABR82S**

**ALFA ROMEO / FIAT**



<b>OEM:</b>	
46481588	
46520658	
<b>EQUIVALÊNCIAS:</b>	
MANN	C25100
MAHLE	LX618
FRAM	CA5630A
WEGA	FAP5303
TECFIL	ARL2507
<b>MEDIDAS (mm):</b>	
COMPRIMENTO	245
LARGURA	168
ALTURA	57
D. INTERNO	
D. EXTERNO	
ROSCA	
BICOS	

**FABR83S**

**TOYOTA**



<b>OEM:</b>	
178010Y020	
<b>EQUIVALÊNCIAS:</b>	
MANN	
MAHLE	
FRAM	
WEGA	
TECFIL	ARL2204
<b>MEDIDAS (mm):</b>	
COMPRIMENTO	335
LARGURA	168
ALTURA	38
D. INTERNO	
D. EXTERNO	
ROSCA	
BICOS	

**FABR84S**

**MB**



<b>OEM:</b>	
A0000903751	
0000903751	
<b>EQUIVALÊNCIAS:</b>	
MANN	C4312/1
MAHLE	LX1845
FRAM	CA10330
WEGA	
TECFIL	
<b>MEDIDAS (mm):</b>	
COMPRIMENTO	354
LARGURA	264
ALTURA	56,6
D. INTERNO	
D. EXTERNO	
ROSCA	
BICOS	

**FABR85S**

**FIAT**



<b>OEM:</b>	
46817415	
55191607	
<b>EQUIVALÊNCIAS:</b>	
MANN	C25116
MAHLE	LX2642
FRAM	CA9378
WEGA	FAP9006
TECFIL	ARL4415
<b>MEDIDAS (mm):</b>	
COMPRIMENTO	247
LARGURA	193
ALTURA	42
D. INTERNO	
D. EXTERNO	
ROSCA	
BICOS	



FORD	<b>FABR86S</b>	OEM: CN159601AB	
		EQUIVALÊNCIAS:	
		MANN	
		MAHLE	LX2867
FRAM			
WEGA			
TECFIL			
MEDIDAS (mm):			
COMPRIMENTO	168		
LARGURA	154/187		
ALTURA	70		
D. INTERNO			
D. EXTERNO			
ROSCA			
BICOS			

FORD	<b>FABR87S</b>	OEM: DS7Z9601A	
		EQUIVALÊNCIAS:	
		MANN	
		MAHLE	
FRAM			
WEGA			
TECFIL			
MEDIDAS (mm):			
COMPRIMENTO	197		
LARGURA	245		
ALTURA	65		
D. INTERNO			
D. EXTERNO			
ROSCA			
BICOS			

FORD	<b>FABR88S</b>	OEM: AB399601AB	
		EQUIVALÊNCIAS:	
		MANN	
		MAHLE	
FRAM			
WEGA		WR191	
TECFIL			
MEDIDAS (mm):			
COMPRIMENTO			
LARGURA			
ALTURA	138		
D. INTERNO	136		
D. EXTERNO	220		
ROSCA			
BICOS			

CHEVROLET	<b>FABR89S</b>	OEM: 94757663	
		EQUIVALÊNCIAS:	
		MANN	
		MAHLE	
FRAM		CA10891	
WEGA			
TECFIL	ARL8830		
MEDIDAS (mm):			
COMPRIMENTO	172		
LARGURA	241		
ALTURA	48		
D. INTERNO			
D. EXTERNO			
ROSCA			
BICOS			

HONDA	<b>FABR90S</b>	OEM: 17220R6AJ00	
		EQUIVALÊNCIAS:	
		MANN	
		MAHLE	
FRAM			
WEGA			
TECFIL			
MEDIDAS (mm):			
COMPRIMENTO	245		
LARGURA	159		
ALTURA	45		
D. INTERNO			
D. EXTERNO			
ROSCA			
BICOS			

JAC	<b>FABR91S</b>	OEM: 1109130U9020	
		EQUIVALÊNCIAS:	
		MANN	
		MAHLE	
FRAM			
WEGA			
TECFIL			
MEDIDAS (mm):			
COMPRIMENTO	124		
LARGURA	250		
ALTURA	53		
D. INTERNO			
D. EXTERNO			
ROSCA			
BICOS			

AUDI	<b>FABR92S</b>	OEM: 6RO129620A	
		EQUIVALÊNCIAS:	
		MANN	C15008
		MAHLE	LX2881
FRAM		CA10822	
WEGA		WR212	
TECFIL			
MEDIDAS (mm):			
COMPRIMENTO			
LARGURA			
ALTURA	170		
D. INTERNO	74		
D. EXTERNO	49,5		
ROSCA			
BICOS			

CITROËN	<b>FABR93S</b>	OEM: 1444VK	
		EQUIVALÊNCIAS:	
		MANN	C4371
		MAHLE	
FRAM		CA10788	
WEGA		FAP4054/3	
TECFIL			
MEDIDAS (mm):			
COMPRIMENTO	425		
LARGURA	95		
ALTURA	55		
D. INTERNO			
D. EXTERNO			
ROSCA			
BICOS			

HYUNDAI / KIA	<b>FABR94S</b>	OEM: 281133X000	
		EQUIVALÊNCIAS:	
		MANN	
		MAHLE	
FRAM		CA10889	
WEGA		JFAH26	
TECFIL			
MEDIDAS (mm):			
COMPRIMENTO	259		
LARGURA	164		
ALTURA	52		
D. INTERNO			
D. EXTERNO			
ROSCA			
BICOS			

BMW	<b>FABR95S</b>	OEM: 13718507320 13717630911	
		EQUIVALÊNCIAS:	
		MANN	C24025
		MAHLE	LX2077/5
FRAM			
WEGA			
TECFIL			
MEDIDAS (mm):			
COMPRIMENTO	231		
LARGURA	205		
ALTURA	44		
D. INTERNO			
D. EXTERNO			
ROSCA			
BICOS			

**FABR96S**

**BMW**



<b>OEM:</b>	
13717571355	
<b>EQUIVALÊNCIAS:</b>	
MANN	C28125
MAHLE	LX2525
FRAM	CA11118
WEGA	FAP4819
TECFIL	
<b>MEDIDAS (mm):</b>	
COMPRIMENTO	276,5
LARGURA	261,5
ALTURA	35,5
D. INTERNO	
D. EXTERNO	
ROSCA	
BICOS	

**FABR97S**

**DODGE / JEEP / LEXUS / TOYOTA**



<b>OEM:</b>	
04861756AA 4861756AA	
<b>EQUIVALÊNCIAS:</b>	
MANN	
MAHLE	
FRAM	CA10755
WEGA	JFA993
TECFIL	
<b>MEDIDAS (mm):</b>	
COMPRIMENTO	245
LARGURA	223
ALTURA	55
D. INTERNO	
D. EXTERNO	
ROSCA	
BICOS	

**FABR98S**

**CHRYSLER / DODGE**



<b>OEM:</b>	
4861737AA 04861737AA	
<b>EQUIVALÊNCIAS:</b>	
MANN	
MAHLE	
FRAM	CA11050
WEGA	
TECFIL	
<b>MEDIDAS (mm):</b>	
COMPRIMENTO	324
LARGURA	249
ALTURA	44
D. INTERNO	
D. EXTERNO	
ROSCA	
BICOS	

**FABR99S**

**CHRYSLER / DODGE**



<b>OEM:</b>	
68081249AC	
<b>EQUIVALÊNCIAS:</b>	
MANN	
MAHLE	
FRAM	CA11170
WEGA	JFA994
TECFIL	
<b>MEDIDAS (mm):</b>	
COMPRIMENTO	235
LARGURA	228
ALTURA	47
D. INTERNO	
D. EXTERNO	
ROSCA	
BICOS	

**FABR100S**

**CHRYSLER / DODGE**



<b>OEM:</b>	
04861746AB 04861746AA	
<b>EQUIVALÊNCIAS:</b>	
MANN	
MAHLE	
FRAM	CA11257
WEGA	
TECFIL	
<b>MEDIDAS (mm):</b>	
COMPRIMENTO	362
LARGURA	231
ALTURA	37
D. INTERNO	
D. EXTERNO	
ROSCA	
BICOS	

**FABR101S**

**DODGE / FIAT**



<b>OEM:</b>	
4891916AA	
<b>EQUIVALÊNCIAS:</b>	
MANN	MA1028
MAHLE	LX3021
FRAM	CA10516
WEGA	JFA987
TECFIL	
<b>MEDIDAS (mm):</b>	
COMPRIMENTO	233
LARGURA	213
ALTURA	47
D. INTERNO	
D. EXTERNO	
ROSCA	
BICOS	

**FABR102S**

**FORD**



<b>OEM:</b>	
97KB9601AB 97KB9601BA	
<b>EQUIVALÊNCIAS:</b>	
MANN	C2982/1
MAHLE	LX962
FRAM	CA5837
WEGA	FAP3608
TECFIL	ARL9604
<b>MEDIDAS (mm):</b>	
COMPRIMENTO	287
LARGURA	156,9
ALTURA	54,5
D. INTERNO	
D. EXTERNO	
ROSCA	
BICOS	

**FABR103S**

**FIAT**



<b>OEM:</b>	
7077767 71736122	
<b>EQUIVALÊNCIAS:</b>	
MANN	C2571/1
MAHLE	LX453
FRAM	CA5140
WEGA	FAP5301
TECFIL	ARL2506
<b>MEDIDAS (mm):</b>	
COMPRIMENTO	247
LARGURA	131
ALTURA	54
D. INTERNO	
D. EXTERNO	
ROSCA	
BICOS	

**FABR104S**

**FORD**



<b>OEM:</b>	
91FF9601AA	
<b>EQUIVALÊNCIAS:</b>	
MANN	C26138/1
MAHLE	LX435
FRAM	CA5357
WEGA	FAP4831
TECFIL	ARL9601
<b>MEDIDAS (mm):</b>	
COMPRIMENTO	259
LARGURA	185
ALTURA	58,5
D. INTERNO	
D. EXTERNO	
ROSCA	
BICOS	

**FABR105S**

**MB**



<b>OEM:</b>	
2760940004	
<b>EQUIVALÊNCIAS:</b>	
MANN	C43139
MAHLE	LX3140
FRAM	
WEGA	FAP4847
TECFIL	
<b>MEDIDAS (mm):</b>	
COMPRIMENTO	424
LARGURA	198,5
ALTURA	31,5
D. INTERNO	
D. EXTERNO	
ROSCA	
BICOS	



FORD	<b>FABR106S</b>	OEM: AR3Z9601B FA1897	
		EQUIVALÊNCIAS:	
		MANN	
		MAHLE	
		FRAM	CA10781
		WEGA	
TECFIL			
MEDIDAS (mm):			
COMPRIMENTO	309/217		
LARGURA	244		
ALTURA	58		
D. INTERNO			
D. EXTERNO			
ROSCA			
BICOS			

HYUNDAI	<b>FABR107S</b>	OEM: 281133M100	
		EQUIVALÊNCIAS:	
		MANN	
		MAHLE	
		FRAM	CA10661
		WEGA	
TECFIL			
MEDIDAS (mm):			
COMPRIMENTO	298		
LARGURA	271		
ALTURA	54		
D. INTERNO			
D. EXTERNO			
ROSCA			
BICOS			

FIAT	<b>FABR108S</b>	OEM: 52022346AA 68082570AA	
		EQUIVALÊNCIAS:	
		MANN	C29005
		MAHLE	
		FRAM	CA11250
		WEGA	
TECFIL			
MEDIDAS (mm):			
COMPRIMENTO	377		
LARGURA	138,5		
ALTURA	40,5		
D. INTERNO			
D. EXTERNO			
ROSCA			
BICOS			

CHEVROLET	<b>FABR109S</b>	OEM: BD8T9601D 479981	
		EQUIVALÊNCIAS:	
		MANN	C17225/3
		MAHLE	LX236
		FRAM	CA4202
		WEGA	WAP162
TECFIL	AP2710		
MEDIDAS (mm):			
COMPRIMENTO			
LARGURA			
ALTURA	352		
D. INTERNO	87		
D. EXTERNO	164		
ROSCA			
BICOS			

CHEVROLET	<b>FABR110S</b>	OEM: 93240236 79TU9601B	
		EQUIVALÊNCIAS:	
		MANN	C15165/3
		MAHLE	LX275
		FRAM	CA3295
		WEGA	WAP161
TECFIL	AP7108		
MEDIDAS (mm):			
COMPRIMENTO			
LARGURA			
ALTURA	338		
D. INTERNO	72		
D. EXTERNO	148		
ROSCA			
BICOS			

AUDI	<b>FABR111S</b>	OEM: 4E.0129620A 4EO129620D	
		EQUIVALÊNCIAS:	
		MANN	C1343
		MAHLE	
		FRAM	
		WEGA	WR367
TECFIL			
MEDIDAS (mm):			
COMPRIMENTO			
LARGURA			
ALTURA	155		
D. INTERNO	86,5		
D. EXTERNO	152		
ROSCA			
BICOS			

AUDI	<b>FABR112S</b>	OEM: 4GO133843	
		EQUIVALÊNCIAS:	
		MANN	C16005
		MAHLE	LX2049/4
		FRAM	
		WEGA	WR369
TECFIL			
MEDIDAS (mm):			
COMPRIMENTO			
LARGURA			
ALTURA	186,5		
D. INTERNO	90,5 / 30,5		
D. EXTERNO	162		
ROSCA			
BICOS			

AUDI	<b>FABR113S</b>	OEM: 8K0133843	
		EQUIVALÊNCIAS:	
		MANN	C16114X
		MAHLE	LX2091D
		FRAM	CA10845
		WEGA	
TECFIL			
MEDIDAS (mm):			
COMPRIMENTO			
LARGURA			
ALTURA	167,5		
D. INTERNO	106		
D. EXTERNO	188		
ROSCA			
BICOS			

MB	<b>FABR114S</b>	OEM: 2750940104 2750940204	
		EQUIVALÊNCIAS:	
		MANN	C25110-2
		MAHLE	
		FRAM	
		WEGA	
TECFIL			
MEDIDAS (mm):			
COMPRIMENTO	248		
LARGURA	210		
ALTURA	50		
D. INTERNO			
D. EXTERNO			
ROSCA			
BICOS			

BMW	<b>FABR115S</b>	OEM: 13717582908	
		EQUIVALÊNCIAS:	
		MANN	C27125
		MAHLE	LX2787
		FRAM	
		WEGA	FAP9285
TECFIL			
MEDIDAS (mm):			
COMPRIMENTO	271		
LARGURA	229		
ALTURA	52		
D. INTERNO			
D. EXTERNO			
ROSCA			
BICOS			

**FABR116S**

BMW



OEM:	
13717590597	
EQUIVALÊNCIAS:	
MANN	C30003
MAHLE	LX1741
FRAM	CA11209
WEGA	
TECFIL	
MEDIDAS (mm):	
COMPRIMENTO	292
LARGURA	158,5/203
ALTURA	46
D. INTERNO	
D. EXTERNO	
ROSCA	
BICOS	

**FABR117S**

BMW



OEM:	
13717601868	
EQUIVALÊNCIAS:	
MANN	C30013
MAHLE	LX1991
FRAM	
WEGA	
TECFIL	
MEDIDAS (mm):	
COMPRIMENTO	312
LARGURA	258
ALTURA	37
D. INTERNO	
D. EXTERNO	
ROSCA	
BICOS	

**FABR118S**

BMW



OEM:	
13717521038	
13717521033	
EQUIVALÊNCIAS:	
MANN	C30139
MAHLE	LX944
FRAM	CA10022
WEGA	
TECFIL	
MEDIDAS (mm):	
COMPRIMENTO	294
LARGURA	230
ALTURA	46
D. INTERNO	
D. EXTERNO	
ROSCA	
BICOS	

**FABR119S**

BMW



OEM:	
13717521023	
13717521037	
EQUIVALÊNCIAS:	
MANN	C31149
MAHLE	LX982
FRAM	
WEGA	
TECFIL	
MEDIDAS (mm):	
COMPRIMENTO	312
LARGURA	272
ALTURA	42
D. INTERNO	
D. EXTERNO	
ROSCA	
BICOS	

**FABR120S**

MB



OEM:	
1120940404	
EQUIVALÊNCIAS:	
MANN	C3170/1-2
MAHLE	LX1466/S
FRAM	
WEGA	FAP4030
TECFIL	
MEDIDAS (mm):	
COMPRIMENTO	307
LARGURA	120
ALTURA	42
D. INTERNO	
D. EXTERNO	
ROSCA	
BICOS	

**FABR121S**

MB



OEM:	
2710940304	
EQUIVALÊNCIAS:	
MANN	C3210
MAHLE	LX2813
FRAM	CA10878
WEGA	
TECFIL	
MEDIDAS (mm):	
COMPRIMENTO	311,5
LARGURA	101/143,7
ALTURA	52
D. INTERNO	
D. EXTERNO	
ROSCA	
BICOS	

**FABR122S**

MB



OEM:	
1560940504	
EQUIVALÊNCIAS:	
MANN	C3361-2
MAHLE	
FRAM	
WEGA	FAP9016
TECFIL	
MEDIDAS (mm):	
COMPRIMENTO	300
LARGURA	155
ALTURA	25
D. INTERNO	
D. EXTERNO	
ROSCA	
BICOS	

**FABR123S**

BMW



OEM:	
13717556961	
EQUIVALÊNCIAS:	
MANN	C36004
MAHLE	LX1564
FRAM	CA10676
WEGA	FAP2415
TECFIL	
MEDIDAS (mm):	
COMPRIMENTO	286
LARGURA	356
ALTURA	37
D. INTERNO	
D. EXTERNO	
ROSCA	
BICOS	

**FABR124S**

AUDI / VW



OEM:	
1K0129620	
EQUIVALÊNCIAS:	
MANN	C36188
MAHLE	LX1500
FRAM	CA10328
WEGA	FAP9039
TECFIL	
MEDIDAS (mm):	
COMPRIMENTO	344
LARGURA	222
ALTURA	51
D. INTERNO	
D. EXTERNO	
ROSCA	
BICOS	

**FABR125S**

JEEP



OEM:	
4593914AB	
EQUIVALÊNCIAS:	
MANN	
MAHLE	
FRAM	CA11048
WEGA	
TECFIL	
MEDIDAS (mm):	
COMPRIMENTO	
LARGURA	
ALTURA	173
D. INTERNO	80
D. EXTERNO	37
ROSCA	
BICOS	



**CHEVROLET**

**FABR126S**



<b>OEM:</b>	
15106528	
<b>EQUIVALÊNCIAS:</b>	
MANN	C40135
MAHLE	LX1316
FRAM	CA3914
WEGA	FAP3266
TECFIL	ARL8841
<b>MEDIDAS (mm):</b>	
COMPRIMENTO	405
LARGURA	200
ALTURA	50
D. INTERNO	
D. EXTERNO	
ROSCA	
BICOS	

**MB**

**FABR127S**



<b>OEM:</b>	
1370940104	
<b>EQUIVALÊNCIAS:</b>	
MANN	C2995/2
MAHLE	
FRAM	
WEGA	FAP9114
TECFIL	
<b>MEDIDAS (mm):</b>	
COMPRIMENTO	257
LARGURA	207
ALTURA	38
D. INTERNO	
D. EXTERNO	
ROSCA	
BICOS	

**MB**

**FABR128S**



<b>OEM:</b>	
30945404	
20948704	
<b>EQUIVALÊNCIAS:</b>	
MANN	C41173
MAHLE	LX114
FRAM	CA4964
WEGA	FAP4013
TECFIL	
<b>MEDIDAS (mm):</b>	
COMPRIMENTO	
LARGURA	
ALTURA	84
D. INTERNO	326
D. EXTERNO	408
ROSCA	
BICOS	

**MINI**

**FABR129S**



<b>OEM:</b>	
13717558382	
13720395826	
<b>EQUIVALÊNCIAS:</b>	
MANN	
MAHLE	LX1628
FRAM	CA11283
WEGA	
TECFIL	
<b>MEDIDAS (mm):</b>	
COMPRIMENTO	
LARGURA	
ALTURA	206
D. INTERNO	86
D. EXTERNO	118
ROSCA	
BICOS	

**BMW**

**FABR130S**



<b>OEM:</b>	
13717577458	
<b>EQUIVALÊNCIAS:</b>	
MANN	
MAHLE	LX1684/5
FRAM	
WEGA	
TECFIL	
<b>MEDIDAS (mm):</b>	
COMPRIMENTO	399
LARGURA	295
ALTURA	104
D. INTERNO	
D. EXTERNO	
ROSCA	
BICOS	

**BMW**

**FABR131S**



<b>OEM:</b>	
13717577457	
<b>EQUIVALÊNCIAS:</b>	
MANN	
MAHLE	LX1685/5
FRAM	
WEGA	
TECFIL	
<b>MEDIDAS (mm):</b>	
COMPRIMENTO	399
LARGURA	295
ALTURA	104
D. INTERNO	
D. EXTERNO	
ROSCA	
BICOS	

**HYUNDAI**

**FABR132S**



<b>OEM:</b>	
281131S100	
<b>EQUIVALÊNCIAS:</b>	
MANN	
MAHLE	LX3452
FRAM	
WEGA	
TECFIL	
<b>MEDIDAS (mm):</b>	
COMPRIMENTO	234
LARGURA	138
ALTURA	54
D. INTERNO	
D. EXTERNO	
ROSCA	
BICOS	

**FIAT**

**FABR133S**



<b>OEM:</b>	
7528122	
<b>EQUIVALÊNCIAS:</b>	
MANN	C13100
MAHLE	LX961
FRAM	CA5356
WEGA	
TECFIL	AR4148
<b>MEDIDAS (mm):</b>	
COMPRIMENTO	
LARGURA	
ALTURA	283
D. INTERNO	74,5
D. EXTERNO	123,5
ROSCA	
BICOS	

**BMW**

**FABR134S**



<b>OEM:</b>	
13717589642	
<b>EQUIVALÊNCIAS:</b>	
MANN	
MAHLE	LX1824/1
FRAM	
WEGA	
TECFIL	
<b>MEDIDAS (mm):</b>	
COMPRIMENTO	323
LARGURA	105
ALTURA	83
D. INTERNO	
D. EXTERNO	
ROSCA	
BICOS	

**MB**

**FABR135S**



<b>OEM:</b>	
0010942704	
<b>EQUIVALÊNCIAS:</b>	
MANN	C36157
MAHLE	LX211
FRAM	CA2735
WEGA	
TECFIL	
<b>MEDIDAS (mm):</b>	
COMPRIMENTO	
LARGURA	
ALTURA	81
D. INTERNO	251
D. EXTERNO	360
ROSCA	
BICOS	

**FABR136S**

MB



<b>OEM:</b>	
6170940004 10948604	
<b>EQUIVALÊNCIAS:</b>	
MANN	C15120
MAHLE	LX228
FRAM	CA3156
WEGA	
TECFIL	
<b>MEDIDAS (mm):</b>	
COMPRIMENTO	
LARGURA	
ALTURA	222
D. INTERNO	88
D. EXTERNO	152
ROSCA	
BICOS	

**FABR137S**

SCANIA CAMINHÕES

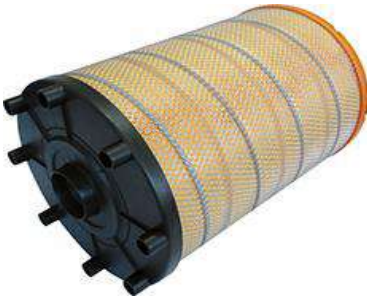

<b>OEM:</b>	
1869995 1728667	
<b>EQUIVALÊNCIAS:</b>	
MANN	
MAHLE	
FRAM	
WEGA	
TECFIL	ARS1184
<b>MEDIDAS (mm):</b>	
COMPRIMENTO	
LARGURA	
ALTURA	445
D. INTERNO	170
D. EXTERNO	300
ROSCA	
BICOS	

**FABR138S**

VOLVO CAMINHÕES

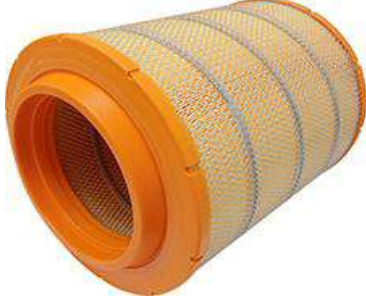

<b>OEM:</b>	
21115483	
<b>EQUIVALÊNCIAS:</b>	
MANN	C331460
MAHLE	LX3141
FRAM	
WEGA	
TECFIL	ARS5574
<b>MEDIDAS (mm):</b>	
COMPRIMENTO	
LARGURA	
ALTURA	425
D. INTERNO	200
D. EXTERNO	330
ROSCA	
BICOS	

**FABR139S**

VOLVO CAMINHÕES



<b>OEM:</b>	
1665898	
<b>EQUIVALÊNCIAS:</b>	
MANN	C321500
MAHLE	LX832
FRAM	
WEGA	
TECFIL	
<b>MEDIDAS (mm):</b>	
COMPRIMENTO	
LARGURA	
ALTURA	416
D. INTERNO	203
D. EXTERNO	332
ROSCA	
BICOS	

**FAH01S**

HYUNDAI



<b>OEM:</b>	
281304A001 HE1923603	
<b>EQUIVALÊNCIAS:</b>	
MANN	C24196
MAHLE	
FRAM	CA9551
WEGA	JFAH01
TECFIL	
<b>MEDIDAS (mm):</b>	
COMPRIMENTO	227/170
LARGURA	137/74,5
ALTURA	189
D. INTERNO	
D. EXTERNO	
ROSCA	
BICOS	

**FAH02S**

HYUNDAI



<b>OEM:</b>	
2811322600	
<b>EQUIVALÊNCIAS:</b>	
MANN	C2562
MAHLE	LX336
FRAM	CA3997
WEGA	FAP3276
TECFIL	
<b>MEDIDAS (mm):</b>	
COMPRIMENTO	248,6
LARGURA	170
ALTURA	40,5
D. INTERNO	
D. EXTERNO	
ROSCA	
BICOS	

**FAH03S**

HYUNDAI / KIA



<b>OEM:</b>	
2811337101 254709130132	
<b>EQUIVALÊNCIAS:</b>	
MANN	C2469
MAHLE	LX1039
FRAM	CA8766
WEGA	JFAH03
TECFIL	
<b>MEDIDAS (mm):</b>	
COMPRIMENTO	236,2
LARGURA	190,8
ALTURA	42
D. INTERNO	
D. EXTERNO	
ROSCA	
BICOS	

**FAH04S**

HYUNDAI / JAC



<b>OEM:</b>	
2811326000 2811026000	
<b>EQUIVALÊNCIAS:</b>	
MANN	C2632/1
MAHLE	LX1041
FRAM	CA9441
WEGA	JFAH04
TECFIL	
<b>MEDIDAS (mm):</b>	
COMPRIMENTO	259
LARGURA	179
ALTURA	50
D. INTERNO	
D. EXTERNO	
ROSCA	
BICOS	

**FAH05S**

HYUNDAI



<b>OEM:</b>	
2811317500	
<b>EQUIVALÊNCIAS:</b>	
MANN	C2421
MAHLE	LX1840
FRAM	CA10117
WEGA	JFAH05
TECFIL	
<b>MEDIDAS (mm):</b>	
COMPRIMENTO	241,5/158,2
LARGURA	193/59
ALTURA	34
D. INTERNO	
D. EXTERNO	
ROSCA	
BICOS	

**FAH06S**

HYUNDAI



<b>OEM:</b>	
28113H1915	
<b>EQUIVALÊNCIAS:</b>	
MANN	C2542
MAHLE	LX2821
FRAM	CA9792
WEGA	JFAH06
TECFIL	
<b>MEDIDAS (mm):</b>	
COMPRIMENTO	245,2
LARGURA	210
ALTURA	43
D. INTERNO	
D. EXTERNO	
ROSCA	
BICOS	



**FAH07S**



**OEM:**  
2811339000

**EQUIVALÊNCIAS:**

MANN	
MAHLE	LX1040
FRAM	
WEGA	JFAH07
TECFIL	

**MEDIDAS (mm):**

COMPRIMENTO	243
LARGURA	197
ALTURA	51
D. INTERNO	
D. EXTERNO	
ROSCA	
BICOS	

KIA

**FAH10S**



**OEM:**  
281132D000  
281132D001

**EQUIVALÊNCIAS:**

MANN	C2676
MAHLE	LX1030
FRAM	CA9392
WEGA	JFAH10
TECFIL	

**MEDIDAS (mm):**

COMPRIMENTO	252
LARGURA	172,5
ALTURA	41,2
D. INTERNO	
D. EXTERNO	
ROSCA	
BICOS	

HYUNDAI / KIA

**FAH12S**



**OEM:**  
2811308000  
281132F250

**EQUIVALÊNCIAS:**

MANN	C2631
MAHLE	LX1785
FRAM	CA10086
WEGA	JFAH12
TECFIL	ARL2331

**MEDIDAS (mm):**

COMPRIMENTO	253,5
LARGURA	172
ALTURA	43,6
D. INTERNO	
D. EXTERNO	
ROSCA	
BICOS	

HYUNDAI / JAC / KIA

**FAH14S**



**OEM:**  
281132B000

**EQUIVALÊNCIAS:**

MANN	C2735
MAHLE	LX2832
FRAM	CA10539
WEGA	JFAH14
TECFIL	

**MEDIDAS (mm):**

COMPRIMENTO	269
LARGURA	174
ALTURA	61
D. INTERNO	
D. EXTERNO	
ROSCA	
BICOS	

HYUNDAI / KIA

**FAH19S**



**OEM:**  
281133J100

**EQUIVALÊNCIAS:**

MANN	
MAHLE	
FRAM	CA10540
WEGA	JFAH17
TECFIL	

**MEDIDAS (mm):**

COMPRIMENTO	285
LARGURA	155
ALTURA	29
D. INTERNO	
D. EXTERNO	
ROSCA	
BICOS	

HYUNDAI

**FAH20S**



**OEM:**  
281133K200

**EQUIVALÊNCIAS:**

MANN	C23006
MAHLE	LX2648
FRAM	CA10084
WEGA	JFAH16
TECFIL	

**MEDIDAS (mm):**

COMPRIMENTO	233
LARGURA	224
ALTURA	55
D. INTERNO	
D. EXTERNO	
ROSCA	
BICOS	

HYUNDAI

**FAH21S**



**OEM:**  
281134F000  
263304X000

**EQUIVALÊNCIAS:**

MANN	
MAHLE	LX3236
FRAM	CA10564
WEGA	JFAH13
TECFIL	AR8113

**MEDIDAS (mm):**

COMPRIMENTO	250
LARGURA	157
ALTURA	135
D. INTERNO	
D. EXTERNO	
ROSCA	
BICOS	

HYUNDAI

**FAH22S**



**OEM:**  
281134H  
281134H000

**EQUIVALÊNCIAS:**

MANN	
MAHLE	LX 2994
FRAM	
WEGA	
TECFIL	

**MEDIDAS (mm):**

COMPRIMENTO	267
LARGURA	189
ALTURA	51
D. INTERNO	
D. EXTERNO	
ROSCA	
BICOS	

HYUNDAI

**FAH23S**



**OEM:**  
281132S000  
2811332100

**EQUIVALÊNCIAS:**

MANN	C26013
MAHLE	LX2869
FRAM	CA10889
WEGA	JFAH21
TECFIL	

**MEDIDAS (mm):**

COMPRIMENTO	259
LARGURA	164
ALTURA	54
D. INTERNO	
D. EXTERNO	
ROSCA	
BICOS	

HYUNDAI

**FAK01S**



**OEM:**  
NK71E23603  
OK71E23603

**EQUIVALÊNCIAS:**

MANN	C22181
MAHLE	LX1068
FRAM	CA5812
WEGA	JFAK01
TECFIL	AP1002

**MEDIDAS (mm):**

COMPRIMENTO	
LARGURA	
ALTURA	100,3
D. INTERNO	132/8
D. EXTERNO	223,6
ROSCA	
BICOS	

ASIA / KIA

**FAK02S**



**OEM:**  
OK55223603A  
OK55223603A

**EQUIVALÊNCIAS:**

MANN	C3065
MAHLE	LX1943
FRAM	CA9658
WEGA	JFAK04/1
TECFIL	

**MEDIDAS (mm):**

COMPRIMENTO	305
LARGURA	196,3
ALTURA	60,8
D. INTERNO	
D. EXTERNO	
ROSCA	
BICOS	

**FAK06S**



**OEM:**  
OK30C13Z40A  
K30C13Z40A

**EQUIVALÊNCIAS:**

MANN	C2658
MAHLE	LX1625
FRAM	CA9277
WEGA	JFAK10
TECFIL	

**MEDIDAS (mm):**

COMPRIMENTO	262,8
LARGURA	144,5
ALTURA	38,6
D. INTERNO	
D. EXTERNO	
ROSCA	
BICOS	

**FAK07S**



**OEM:**  
OK2A513Z40A  
OK2A513Z40

**EQUIVALÊNCIAS:**

MANN	C34100
MAHLE	LX1818
FRAM	CA8548
WEGA	JFAK07
TECFIL	

**MEDIDAS (mm):**

COMPRIMENTO	340
LARGURA	172,5
ALTURA	41,8
D. INTERNO	
D. EXTERNO	
ROSCA	
BICOS	

**FAK08S**



**OEM:**  
OK55813Z40

**EQUIVALÊNCIAS:**

MANN	
MAHLE	LX1942
FRAM	CA9658
WEGA	JFAK08
TECFIL	

**MEDIDAS (mm):**

COMPRIMENTO	270,2
LARGURA	191,4
ALTURA	39,5
D. INTERNO	
D. EXTERNO	
ROSCA	
BICOS	

**FAK10S**



**OEM:**  
281133E500  
281133E000

**EQUIVALÊNCIAS:**

MANN	C3033
MAHLE	LX1955
FRAM	CA9525
WEGA	JFAK10
TECFIL	

**MEDIDAS (mm):**

COMPRIMENTO	297
LARGURA	238,6
ALTURA	32,4
D. INTERNO	
D. EXTERNO	
ROSCA	
BICOS	

**FAK11S**



**OEM:**  
2811307100

**EQUIVALÊNCIAS:**

MANN	C2617
MAHLE	LX2865
FRAM	CA10683
WEGA	JFAK11
TECFIL	ARL2346

**MEDIDAS (mm):**

COMPRIMENTO	253
LARGURA	115
ALTURA	39
D. INTERNO	
D. EXTERNO	
ROSCA	
BICOS	

**FAK12S**



**OEM:**  
AA70A23603A  
OK72C23603

**EQUIVALÊNCIAS:**

MANN	C21105
MAHLE	LX1094
FRAM	CA8840
WEGA	JFA983/1
TECFIL	AP1012

**MEDIDAS (mm):**

COMPRIMENTO	
LARGURA	
ALTURA	130
D. INTERNO	127
D. EXTERNO	206
ROSCA	
BICOS	

**FAK13S**



**OEM:**  
OK60A23603A  
OK60A23603

**EQUIVALÊNCIAS:**

MANN	C182184
MAHLE	LX2972
FRAM	
WEGA	JFAK09/1
TECFIL	

**MEDIDAS (mm):**

COMPRIMENTO	
LARGURA	
ALTURA	202
D. INTERNO	113,8/12
D. EXTERNO	179
ROSCA	
BICOS	

**FAK14S**



**OEM:**  
281134E000

**EQUIVALÊNCIAS:**

MANN	
MAHLE	LX2689
FRAM	
WEGA	JFAK14
TECFIL	ARL2332

**MEDIDAS (mm):**

COMPRIMENTO	
LARGURA	
ALTURA	270
D. INTERNO	111,5
D. EXTERNO	166,5
ROSCA	
BICOS	

**FAK19S**



**OEM:**  
281134D000

**EQUIVALÊNCIAS:**

MANN	
MAHLE	LX2640
FRAM	CA10271
WEGA	JFAK19
TECFIL	

**MEDIDAS (mm):**

COMPRIMENTO	304
LARGURA	160
ALTURA	55
D. INTERNO	
D. EXTERNO	
ROSCA	
BICOS	



KIA	<b>FAK20S</b>	OEM: 281132G000	
		EQUIVALÊNCIAS:	
		MANN	
		MAHLE	
		FRAM	CA10191
WEGA		JFAH09	
MEDIDAS (mm):			
COMPRIMENTO	256		
LARGURA	202		
ALTURA	44		
D. INTERNO			
D. EXTERNO			
ROSCA			
BICOS			

HYUNDAI	<b>FAK21S</b>	OEM: 281132H000	
		EQUIVALÊNCIAS:	
		MANN	C2029
		MAHLE	LX2752
		FRAM	CA10470
WEGA		JFAK21	
MEDIDAS (mm):			
COMPRIMENTO	199		
LARGURA	189		
ALTURA	50		
D. INTERNO			
D. EXTERNO			
ROSCA			
BICOS			

KIA	<b>FAK22S</b>	OEM: 281131J000 281132K000	
		EQUIVALÊNCIAS:	
		MANN	C20014
		MAHLE	LX2739
		FRAM	CA10699
WEGA		JFAK22	
MEDIDAS (mm):			
COMPRIMENTO	247		
LARGURA	130		
ALTURA	54		
D. INTERNO			
D. EXTERNO			
ROSCA			
BICOS			

KIA	<b>FAK23S</b>	OEM: K74R23603	
		EQUIVALÊNCIAS:	
		MANN	
		MAHLE	
		FRAM	
WEGA		JFA983/2	
MEDIDAS (mm):			
COMPRIMENTO			
LARGURA			
ALTURA	129		
D. INTERNO	127		
D. EXTERNO	218		
ROSCA			
BICOS			

KIA	<b>FAK24S</b>	OEM: 281132F800	
		EQUIVALÊNCIAS:	
		MANN	
		MAHLE	LX2890
		FRAM	
WEGA		JFAK18	
MEDIDAS (mm):			
COMPRIMENTO	250		
LARGURA	171		
ALTURA	44,5		
D. INTERNO			
D. EXTERNO			
ROSCA			
BICOS			

KIA	<b>FAK25S</b>	OEM: 281132J000	
		EQUIVALÊNCIAS:	
		MANN	
		MAHLE	
		FRAM	
WEGA		JFAK23	
MEDIDAS (mm):			
COMPRIMENTO	295		
LARGURA	211		
ALTURA	36,5		
D. INTERNO			
D. EXTERNO			
ROSCA			
BICOS			

KIA	<b>FAK26S</b>	OEM: 0K6B023603 NK6B023603	
		EQUIVALÊNCIAS:	
		MANN	
		MAHLE	
		FRAM	
WEGA		JFA983/3	
MEDIDAS (mm):			
COMPRIMENTO			
LARGURA			
ALTURA	244		
D. INTERNO	111		
D. EXTERNO	178		
ROSCA			
BICOS			

HYUNDAI / KIA	<b>FAK27S</b>	OEM: 281132P100	
		EQUIVALÊNCIAS:	
		MANN	C28010
		MAHLE	LX2957
		FRAM	CA10881
WEGA		JFAH24	
MEDIDAS (mm):			
COMPRIMENTO	277		
LARGURA	227		
ALTURA	41		
D. INTERNO			
D. EXTERNO			
ROSCA			
BICOS			

HYUNDAI / KIA	<b>FAK29S</b>	OEM: 2811304000	
		EQUIVALÊNCIAS:	
		MANN	C22019
		MAHLE	LX3271
		FRAM	
WEGA		JFAK16	
MEDIDAS (mm):			
COMPRIMENTO	214		
LARGURA	133		
ALTURA	34		
D. INTERNO			
D. EXTERNO			
ROSCA			
BICOS			

KIA	<b>FAK32S</b>	OEM: 281134E500	
		EQUIVALÊNCIAS:	
		MANN	
		MAHLE	
		FRAM	
WEGA			
MEDIDAS (mm):			
COMPRIMENTO	110		
LARGURA	250		
ALTURA	167		
D. INTERNO			
D. EXTERNO			
ROSCA			
BICOS			

**FAL01S**

LAND ROVER



OEM:	
ESR4238	
EQUIVALÊNCIAS:	
MANN	C25146
MAHLE	LX886
FRAM	CA5891
WEGA	FAP4870
TECFIL	
MEDIDAS (mm):	
COMPRIMENTO	247
LARGURA	207
ALTURA	58
D. INTERNO	
D. EXTERNO	
ROSCA	
BICOS	

**FAL02S**

LAND ROVER



OEM:	
PHE000112 5H2Z9601AA	
EQUIVALÊNCIAS:	
MANN	C31196
MAHLE	LX1764
FRAM	CA9993
WEGA	FAP9023
TECFIL	
MEDIDAS (mm):	
COMPRIMENTO	300
LARGURA	225
ALTURA	58,5
D. INTERNO	
D. EXTERNO	
ROSCA	
BICOS	

**FAL03S**

LAND ROVER



OEM:	
ESR1445	
EQUIVALÊNCIAS:	
MANN	C26126
MAHLE	LX821
FRAM	CA5522
WEGA	FAP4849
TECFIL	
MEDIDAS (mm):	
COMPRIMENTO	263
LARGURA	203
ALTURA	57
D. INTERNO	
D. EXTERNO	
ROSCA	
BICOS	

**FAL05S**

LAND ROVER



OEM:	
13712246997 LR007478	
EQUIVALÊNCIAS:	
MANN	C15105/1
MAHLE	LX823
FRAM	CA8934
WEGA	WR362
TECFIL	
MEDIDAS (mm):	
COMPRIMENTO	
LARGURA	
ALTURA	376
D. INTERNO	88,1
D. EXTERNO	145,1/122
ROSCA	
BICOS	

**FAL06S**

LAND ROVER



OEM:	
13712247444 PHE000040	
EQUIVALÊNCIAS:	
MANN	C15143/1
MAHLE	LX818
FRAM	
WEGA	WR278
TECFIL	
MEDIDAS (mm):	
COMPRIMENTO	
LARGURA	
ALTURA	498
D. INTERNO	89/42
D. EXTERNO	146/99
ROSCA	
BICOS	

**FAL07S**

LAND ROVER



OEM:	
ESR341 ESR0341	
EQUIVALÊNCIAS:	
MANN	C25135
MAHLE	LX980
FRAM	CA5602
WEGA	FAP4852
TECFIL	
MEDIDAS (mm):	
COMPRIMENTO	254
LARGURA	227,5
ALTURA	57,2
D. INTERNO	
D. EXTERNO	
ROSCA	
BICOS	

**FAL09S**

LAND ROVER



OEM:	
ESR1049	
EQUIVALÊNCIAS:	
MANN	C14168
MAHLE	LX822
FRAM	CA5359
WEGA	
TECFIL	
MEDIDAS (mm):	
COMPRIMENTO	
LARGURA	
ALTURA	293,4
D. INTERNO	72/16,2
D. EXTERNO	173,8/138,4
ROSCA	
BICOS	

**FAL10S**

LAND ROVER



OEM:	
ESR4103 PHE100330	
EQUIVALÊNCIAS:	
MANN	C2874
MAHLE	LX719
FRAM	CA5657
WEGA	FAP4850
TECFIL	
MEDIDAS (mm):	
COMPRIMENTO	271
LARGURA	121
ALTURA	58
D. INTERNO	
D. EXTERNO	
ROSCA	
BICOS	

**FAL11S**

LAND ROVER



OEM:	
NTC1435	
EQUIVALÊNCIAS:	
MANN	C14179/2
MAHLE	LX872
FRAM	CA4333
WEGA	
TECFIL	
MEDIDAS (mm):	
COMPRIMENTO	
LARGURA	
ALTURA	285,5
D. INTERNO	72 / 16,5
D. EXTERNO	138
ROSCA	
BICOS	

**FAL12S**

LAND ROVER



OEM:	
ESR2623 ESR2102	
EQUIVALÊNCIAS:	
MANN	C14160
MAHLE	LX952
FRAM	CA5572
WEGA	
TECFIL	
MEDIDAS (mm):	
COMPRIMENTO	
LARGURA	
ALTURA	286
D. INTERNO	70/16,5
D. EXTERNO	131,5
ROSCA	
BICOS	



**FAL14S**

CADILLAC / LAND ROVER



OEM:	
LR005816	
LR003011	
EQUIVALÊNCIAS:	
MANN	C28155
MAHLE	LX1957
FRAM	CA10432
WEGA	FAP4858
TECFIL	
MEDIDAS (mm):	
COMPRIMENTO	273
LARGURA	182
ALTURA	57
D. INTERNO	
D. EXTERNO	
ROSCA	
BICOS	

**FAL17S**

LAND ROVER



OEM:	
LR11593	
EQUIVALÊNCIAS:	
MANN	C35126
MAHLE	
FRAM	CA11062
WEGA	FAP4860
TECFIL	
MEDIDAS (mm):	
COMPRIMENTO	345
LARGURA	163
ALTURA	50
D. INTERNO	
D. EXTERNO	
ROSCA	
BICOS	

**FAL18S**

LAND ROVER



OEM:	
LR029078	
BJ329601AA	
EQUIVALÊNCIAS:	
MANN	C29006
MAHLE	LX3246
FRAM	
WEGA	FAP9287
TECFIL	
MEDIDAS (mm):	
COMPRIMENTO	286
LARGURA	180
ALTURA	59
D. INTERNO	
D. EXTERNO	
ROSCA	
BICOS	

**FAM00S**

SMART



OEM:	
0001024V001	
0003123V007	
EQUIVALÊNCIAS:	
MANN	C1036/1
MAHLE	LX1805
FRAM	CA9429
WEGA	WR224
TECFIL	
MEDIDAS (mm):	
COMPRIMENTO	
LARGURA	
ALTURA	137,4
D. INTERNO	47,5
D. EXTERNO	90,2
ROSCA	
BICOS	

**FAM01S**

SMART



OEM:	
1500A045	
8200792661	
EQUIVALÊNCIAS:	
MANN	C2561
MAHLE	LX1008/1
FRAM	CA10599
WEGA	
TECFIL	
MEDIDAS (mm):	
COMPRIMENTO	247,5
LARGURA	116
ALTURA	62,2
D. INTERNO	
D. EXTERNO	
ROSCA	
BICOS	

**FAM02S**

SMART



OEM:	
0009997V001	
1600940104	
EQUIVALÊNCIAS:	
MANN	C1036/2
MAHLE	LX1792
FRAM	CA9768
WEGA	
TECFIL	
MEDIDAS (mm):	
COMPRIMENTO	
LARGURA	
ALTURA	136
D. INTERNO	50
D. EXTERNO	93
ROSCA	
BICOS	

**FAM03S**

SMART



OEM:	
A0010940301	
EQUIVALÊNCIAS:	
MANN	C2716
MAHLE	
FRAM	CA10290
WEGA	FAP4018
TECFIL	
MEDIDAS (mm):	
COMPRIMENTO	268
LARGURA	111
ALTURA	36
D. INTERNO	
D. EXTERNO	
ROSCA	
BICOS	

**FAS01S**

MB / SSANGYONG



OEM:	
2319008400	
278909130106	
EQUIVALÊNCIAS:	
MANN	C36168
MAHLE	LX536
FRAM	
WEGA	JFAS01
TECFIL	
MEDIDAS (mm):	
COMPRIMENTO	361
LARGURA	170
ALTURA	60
D. INTERNO	
D. EXTERNO	
ROSCA	
BICOS	

**FAS02S**

SSANGYONG



OEM:	
2319008040	
EQUIVALÊNCIAS:	
MANN	
MAHLE	
FRAM	
WEGA	JFAS02
TECFIL	
MEDIDAS (mm):	
COMPRIMENTO	361
LARGURA	204,5
ALTURA	60,6
D. INTERNO	
D. EXTERNO	
ROSCA	
BICOS	

**FAS03S**

SSANGYONG



OEM:	
2319021000	
2319021001	
EQUIVALÊNCIAS:	
MANN	C30171
MAHLE	LX2048
FRAM	
WEGA	JFAS03
TECFIL	
MEDIDAS (mm):	
COMPRIMENTO	300
LARGURA	239,5
ALTURA	59
D. INTERNO	
D. EXTERNO	
ROSCA	
BICOS	

**SSANGYONG**

**FAS04S**



<b>OEM:</b>	
2311334100 2311334101	
<b>EQUIVALÊNCIAS:</b>	
MANN	
MAHLE	
FRAM	
WEGA	FAP9291
TECFIL	
<b>MEDIDAS (mm):</b>	
COMPRIMENTO	219
LARGURA	145
ALTURA	57
D. INTERNO	
D. EXTERNO	
ROSCA	
BICOS	

**DAEWOO**

**FAW00S**



<b>OEM:</b>	
1378078B 1378078B00	
<b>EQUIVALÊNCIAS:</b>	
MANN	C2212
MAHLE	
FRAM	CA9300
WEGA	JFAW00
TECFIL	
<b>MEDIDAS (mm):</b>	
COMPRIMENTO	
LARGURA	
ALTURA	30,7
D. INTERNO	33
D. EXTERNO	222,5
ROSCA	
BICOS	

**DAEWOO**

**FAW01S**



<b>OEM:</b>	
96351225	
<b>EQUIVALÊNCIAS:</b>	
MANN	C2634/2
MAHLE	LX828
FRAM	CA8731
WEGA	JFAW01
TECFIL	
<b>MEDIDAS (mm):</b>	
COMPRIMENTO	258
LARGURA	222,2
ALTURA	34
D. INTERNO	
D. EXTERNO	
ROSCA	
BICOS	

**DAEWOO**

**FAW02S**



<b>OEM:</b>	
96314494 DA742	
<b>EQUIVALÊNCIAS:</b>	
MANN	C2119
MAHLE	LX877
FRAM	CA8797
WEGA	JFAW02
TECFIL	
<b>MEDIDAS (mm):</b>	
COMPRIMENTO	203,5
LARGURA	190,5
ALTURA	35,5
D. INTERNO	
D. EXTERNO	
ROSCA	
BICOS	

**CHEVROLET**

**FAW11S**



<b>OEM:</b>	
13272717 835056	
<b>EQUIVALÊNCIAS:</b>	
MANN	C26106
MAHLE	LX 2882
FRAM	CA10879
WEGA	FAP3261
TECFIL	ARL8828
<b>MEDIDAS (mm):</b>	
COMPRIMENTO	249
LARGURA	255
ALTURA	35
D. INTERNO	
D. EXTERNO	
ROSCA	
BICOS	

**CHEVROLET**

**FAW13S**



<b>OEM:</b>	
96827723	
<b>EQUIVALÊNCIAS:</b>	
MANN	C36013
MAHLE	LX3152
FRAM	CA11071
WEGA	
TECFIL	
<b>MEDIDAS (mm):</b>	
COMPRIMENTO	360
LARGURA	157
ALTURA	33
D. INTERNO	
D. EXTERNO	
ROSCA	
BICOS	

**FIAT / MINI**

**FO007S**



<b>OEM:</b>	
5015901AA 55231651	
<b>EQUIVALÊNCIAS:</b>	
MANN	HU816/2X
MAHLE	OX175D
FRAM	CH9584
WEGA	WOE222
TECFIL	PEL119
<b>MEDIDAS (mm):</b>	
COMPRIMENTO	
LARGURA	
ALTURA	83
D. INTERNO	33,4/22
D. EXTERNO	70,5
ROSCA	
BICOS	

**SUZUKI**

**FO010S**



<b>OEM:</b>	
104884900AB 4884900AB	
<b>EQUIVALÊNCIAS:</b>	
MANN	
MAHLE	OC614
FRAM	PH10125
WEGA	
TECFIL	
<b>MEDIDAS (mm):</b>	
COMPRIMENTO	
LARGURA	
ALTURA	76
D. INTERNO	64
D. EXTERNO	81
ROSCA	M22x1,5
BICOS	

**MAHINDRA**

**FO012S**



<b>OEM:</b>	
9420000073	
<b>EQUIVALÊNCIAS:</b>	
MANN	
MAHLE	
FRAM	
WEGA	JFOM00
TECFIL	
<b>MEDIDAS (mm):</b>	
COMPRIMENTO	
LARGURA	
ALTURA	117
D. INTERNO	70
D. EXTERNO	93
ROSCA	M20x1,5
BICOS	

**CADILLAC / CHEVROLET / HUMMER**

**FO013S**



<b>OEM:</b>	
89017342	
<b>EQUIVALÊNCIAS:</b>	
MANN	
MAHLE	
FRAM	PH9837
WEGA	
TECFIL	
<b>MEDIDAS (mm):</b>	
COMPRIMENTO	
LARGURA	
ALTURA	104
D. INTERNO	70
D. EXTERNO	75
ROSCA	13/16x16
BICOS	



CADILLAC / CHEVROLET / CADILLAC / HUMMER

### FO014S



<b>OEM:</b>	
88984215 8889842150	
<b>EQUIVALÊNCIAS:</b>	
MANN	ML1013
MAHLE	
FRAM	PH3506
WEGA	JFO103
TECFIL	
<b>MEDIDAS (mm):</b>	
<b>COMPRIMENTO</b>	
<b>LARGURA</b>	
ALTURA	88
D. INTERNO	70
D. EXTERNO	75
ROSCA	13/16x16
BICOS	

CHERY

### FO015S



<b>OEM:</b>	
481H1012010	
<b>EQUIVALÊNCIAS:</b>	
MANN	
MAHLE	
FRAM	
WEGA	JFOF02
TECFIL	
<b>MEDIDAS (mm):</b>	
<b>COMPRIMENTO</b>	
<b>LARGURA</b>	
ALTURA	103
D. INTERNO	86
D. EXTERNO	90
ROSCA	M20x1,5
BICOS	

DODGE / GMC / JEEP

### FO097S



<b>OEM:</b>	
05003558AA 72674028	
<b>EQUIVALÊNCIAS:</b>	
MANN	W719/14
MAHLE	OC247
FRAM	PH4478
WEGA	
TECFIL	
<b>MEDIDAS (mm):</b>	
<b>COMPRIMENTO</b>	
<b>LARGURA</b>	
ALTURA	120
D. INTERNO	73
D. EXTERNO	77,8
ROSCA	3/4" x 16
BICOS	

GMC

### FO098S



<b>OEM:</b>	
25014233 ACPF1225	
<b>EQUIVALÊNCIAS:</b>	
MANN	
MAHLE	
FRAM	
WEGA	
TECFIL	
<b>MEDIDAS (mm):</b>	
<b>COMPRIMENTO</b>	
<b>LARGURA</b>	
ALTURA	92
D. INTERNO	71,5
D. EXTERNO	73,7
ROSCA	M18x1,5
BICOS	

NISSAN

### FO110S



<b>OEM:</b>	
1520843G00 1520865005	
<b>EQUIVALÊNCIAS:</b>	
MANN	W932/81
MAHLE	OC67
FRAM	PH2850
WEGA	JFO101
TECFIL	PSL714
<b>MEDIDAS (mm):</b>	
<b>COMPRIMENTO</b>	
<b>LARGURA</b>	
ALTURA	131
D. INTERNO	73
D. EXTERNO	94,5
ROSCA	3/4"x16
BICOS	

NISSAN

### FO111S



<b>OEM:</b>	
1520871J00 1520860V00	
<b>EQUIVALÊNCIAS:</b>	
MANN	W818/82
MAHLE	OC109
FRAM	PH3682
WEGA	JFO111
TECFIL	PSL133
<b>MEDIDAS (mm):</b>	
<b>COMPRIMENTO</b>	
<b>LARGURA</b>	
ALTURA	102,4
D. INTERNO	63
D. EXTERNO	80
ROSCA	3/4"x16
BICOS	

NISSAN

### FO112E



<b>OEM:</b>	
152089C600 710020002	
<b>EQUIVALÊNCIAS:</b>	
MANN	W920/14
MAHLE	OC140
FRAM	PH2978
WEGA	JFO113
TECFIL	
<b>MEDIDAS (mm):</b>	
<b>COMPRIMENTO</b>	
<b>LARGURA</b>	
ALTURA	100
D. INTERNO	71
D. EXTERNO	94
ROSCA	3/4"x16
BICOS	

NISSAN

### FO112S



<b>OEM:</b>	
93156669 NO248	
<b>EQUIVALÊNCIAS:</b>	
MANN	W920/14
MAHLE	OC140
FRAM	PH2978
WEGA	
TECFIL	
<b>MEDIDAS (mm):</b>	
<b>COMPRIMENTO</b>	
<b>LARGURA</b>	
ALTURA	101
D. INTERNO	73
D. EXTERNO	94,4
ROSCA	3/4"x16
BICOS	

JAC / NISSAN / RENAULT

### FO120S



<b>OEM:</b>	
7700112686 8200257642	
<b>EQUIVALÊNCIAS:</b>	
MANN	W67/80
MAHLE	OC205
FRAM	PH6607
WEGA	JFO197
TECFIL	PSL78
<b>MEDIDAS (mm):</b>	
<b>COMPRIMENTO</b>	
<b>LARGURA</b>	
ALTURA	71,5
D. INTERNO	61,5
D. EXTERNO	65,4
ROSCA	M20x1,5
BICOS	

NISSAN / RENAULT

### FO121S



<b>OEM:</b>	
1520800QAG 8200257642	
<b>EQUIVALÊNCIAS:</b>	
MANN	W66
MAHLE	OC475
FRAM	PH9928
WEGA	
TECFIL	
<b>MEDIDAS (mm):</b>	
<b>COMPRIMENTO</b>	
<b>LARGURA</b>	
ALTURA	59,5
D. INTERNO	62
D. EXTERNO	69
ROSCA	M20x1,5
BICOS	

**FO189S**

SUZUKI



<b>OEM:</b>	
152086F901 1651066600	
<b>EQUIVALÊNCIAS:</b>	
MANN	
MAHLE	
FRAM	
WEGA	
TECFIL	
<b>MEDIDAS (mm):</b>	
COMPRIMENTO	
LARGURA	
ALTURA	88
D. INTERNO	
D. EXTERNO	77
ROSCA	M20x1,5
BICOS	

**FO198S**

INFINITY / MAZDA / NISSAN / VOLVO



<b>OEM:</b>	
1520831U00	
<b>EQUIVALÊNCIAS:</b>	
MANN	W610/3
MAHLE	OC194
FRAM	
WEGA	JFO198
TECFIL	
<b>MEDIDAS (mm):</b>	
COMPRIMENTO	
LARGURA	
ALTURA	86
D. INTERNO	61,5
D. EXTERNO	65,4
ROSCA	M20x1,5
BICOS	

**FO206S**

FORD / NISSAN / TOYOTA



<b>OEM:</b>	
1560041010 1560041020	
<b>EQUIVALÊNCIAS:</b>	
MANN	W940/81
MAHLE	OC67
FRAM	PH8A
WEGA	JFO206
TECFIL	PSL714
<b>MEDIDAS (mm):</b>	
COMPRIMENTO	
LARGURA	
ALTURA	140
D. INTERNO	72
D. EXTERNO	94,3
ROSCA	3/4"x16
BICOS	

**FO210S**

LIFAN / TOYOTA



<b>OEM:</b>	
909151003 90915YZZA3	
<b>EQUIVALÊNCIAS:</b>	
MANN	W68/80
MAHLE	OC216
FRAM	PH4967A
WEGA	JFO210
TECFIL	PSL129
<b>MEDIDAS (mm):</b>	
COMPRIMENTO	
LARGURA	
ALTURA	76,2
D. INTERNO	62
D. EXTERNO	65,5
ROSCA	3/4"x16
BICOS	

**FO210/1S**

TOYOTA



<b>OEM:</b>	
909151003 90915YZZA3	
<b>EQUIVALÊNCIAS:</b>	
MANN	W68/80
MAHLE	OC216
FRAM	PH4967
WEGA	JFO210/1
TECFIL	PSL134
<b>MEDIDAS (mm):</b>	
COMPRIMENTO	
LARGURA	
ALTURA	76,2
D. INTERNO	62
D. EXTERNO	65,5
ROSCA	3/4"x16
BICOS	

**FO213S**

MAZDA / TOYOTA



<b>OEM:</b>	
9091530002 9091503006	
<b>EQUIVALÊNCIAS:</b>	
MANN	WP928/80
MAHLE	OC275
FRAM	PH5123
WEGA	JFO213
TECFIL	PSL128
<b>MEDIDAS (mm):</b>	
COMPRIMENTO	
LARGURA	
ALTURA	121,5
D. INTERNO	80
D. EXTERNO	100
ROSCA	M20x1,5
BICOS	

**FO214S**

TOYOTA



<b>OEM:</b>	
9091503004 909151002	
<b>EQUIVALÊNCIAS:</b>	
MANN	W610/1
MAHLE	OC217
FRAM	PH4386
WEGA	JFO214
TECFIL	
<b>MEDIDAS (mm):</b>	
COMPRIMENTO	
LARGURA	
ALTURA	91
D. INTERNO	62
D. EXTERNO	65,4
ROSCA	3/4"x16
BICOS	

**FO215S**

TOYOTA



<b>OEM:</b>	
WLY414302 9091503005	
<b>EQUIVALÊNCIAS:</b>	
MANN	W713/36
MAHLE	OC615
FRAM	PH4985
WEGA	JFO215
TECFIL	
<b>MEDIDAS (mm):</b>	
COMPRIMENTO	
LARGURA	
ALTURA	102
D. INTERNO	70
D. EXTERNO	73,5
ROSCA	3/4"x16
BICOS	

**FO279S**

CHERY / CRYSLER / CHRY / TOYOTA



<b>OEM:</b>	
9091503002 9091520001	
<b>EQUIVALÊNCIAS:</b>	
MANN	W711/80
MAHLE	OC988
FRAM	PH3614
WEGA	JFO211
TECFIL	PSL145
<b>MEDIDAS (mm):</b>	
COMPRIMENTO	
LARGURA	
ALTURA	87,2
D. INTERNO	71,4
D. EXTERNO	76,5
ROSCA	3/4"x16
BICOS	

**FO306S**

KIA



<b>OEM:</b>	
263212W000 825923802	
<b>EQUIVALÊNCIAS:</b>	
MANN	W1114/80
MAHLE	OC239
FRAM	P3828
WEGA	JFO306
TECFIL	PSL322
<b>MEDIDAS (mm):</b>	
COMPRIMENTO	
LARGURA	
ALTURA	84,3
D. INTERNO	98,5
D. EXTERNO	101,4
ROSCA	M20x1,5
BICOS	



**ASIA / KIA / MAZDA / NISSAN**

**F0313S**



OEM:	
0B63114302 B6Y114302A	
EQUIVALÊNCIAS:	
MANN	W67/80
MAHLE	OC195
FRAM	PH6607
WEGA	JFO313
TECFIL	PSL78
MEDIDAS (mm):	
COMPRIMENTO	
LARGURA	
ALTURA	67
D. INTERNO	63
D. EXTERNO	68
ROSCA	M20x1,5
BICOS	

**CHEVROLET / MAZDA / SUZUKI**

**F0314S**



OEM:	
1651678E00 1560187308	
EQUIVALÊNCIAS:	
MANN	WP920/80
MAHLE	OC326
FRAM	PH5190
WEGA	JFO895
TECFIL	
MEDIDAS (mm):	
COMPRIMENTO	
LARGURA	
ALTURA	125
D. INTERNO	86
D. EXTERNO	89,8
ROSCA	M26x1,5
BICOS	

**KIA / MITSUBISHI / NISSAN**

**F0315S**



OEM:	
0FE3R14302 FEY014302	
EQUIVALÊNCIAS:	
MANN	W67/1
MAHLE	OC194
FRAM	PH5317
WEGA	JFO315
TECFIL	PSL152
MEDIDAS (mm):	
COMPRIMENTO	
LARGURA	
ALTURA	86,4
D. INTERNO	64
D. EXTERNO	68,1
ROSCA	M20x1,5
BICOS	

**MAZDA / MITSUBISHI**

**F0316S**



OEM:	
MZ690115 8FG1238029A	
EQUIVALÊNCIAS:	
MANN	W610/3
MAHLE	OC196
FRAM	PH5343
WEGA	
TECFIL	PSL152
MEDIDAS (mm):	
COMPRIMENTO	
LARGURA	
ALTURA	86,6
D. INTERNO	63
D. EXTERNO	68
ROSCA	M20x1,5
BICOS	

**FORD / MAZDA**

**F0394S**



OEM:	
LF10143029A 1218846	
EQUIVALÊNCIAS:	
MANN	W712/73
MAHLE	OC466
FRAM	PH9566
WEGA	
TECFIL	
MEDIDAS (mm):	
COMPRIMENTO	
LARGURA	
ALTURA	97
D. INTERNO	
D. EXTERNO	71,3
ROSCA	3/4"x16
BICOS	

**CHEVROLET / FIAT / DAEWOO / PONTIAC**

**F0398S**



OEM:	
92142009 94797406	
EQUIVALÊNCIAS:	
MANN	W712/22
MAHLE	OC90
FRAM	PH4722
WEGA	WO130
TECFIL	PSL619
MEDIDAS (mm):	
COMPRIMENTO	
LARGURA	
ALTURA	86
D. INTERNO	71
D. EXTERNO	76
ROSCA	M18x1,5
BICOS	

**HONDA**

**F0406S**



OEM:	
15400PC6004 15400PR3004	
EQUIVALÊNCIAS:	
MANN	
MAHLE	OC115
FRAM	PH5317
WEGA	JFO409
TECFIL	PSL131
MEDIDAS (mm):	
COMPRIMENTO	
LARGURA	
ALTURA	102,3
D. INTERNO	63
D. EXTERNO	78
ROSCA	M20x1,5
BICOS	

**HONDA**

**F0407S**



OEM:	
15400P12004 15400PL2004	
EQUIVALÊNCIAS:	
MANN	W815/82
MAHLE	OC256
FRAM	PH8212
WEGA	
TECFIL	
MEDIDAS (mm):	
COMPRIMENTO	
LARGURA	
ALTURA	112
D. INTERNO	77
D. EXTERNO	80
ROSCA	M22x1,5
BICOS	

**FIAT**

**F0410B**



OEM:	
46751179 71736161	
EQUIVALÊNCIAS:	
MANN	W610
MAHLE	OC259
FRAM	PH5949
WEGA	WO120
TECFIL	PSL55
MEDIDAS (mm):	
COMPRIMENTO	
LARGURA	
ALTURA	86
D. INTERNO	
D. EXTERNO	65
ROSCA	M20x1,5
BICOS	

**HONDA**

**F0410S**



OEM:	
15400PLC003 15400PLC004	
EQUIVALÊNCIAS:	
MANN	W610/82
MAHLE	OC196
FRAM	PH8999
WEGA	JFO410
TECFIL	
MEDIDAS (mm):	
COMPRIMENTO	
LARGURA	
ALTURA	86,7
D. INTERNO	62,7
D. EXTERNO	65
ROSCA	M20x1,5
BICOS	

**LAND ROVER**

**FO497S**



<b>OEM:</b>	
ERR5542 15400PDDE00	
<b>EQUIVALÊNCIAS:</b>	
MANN	W920/11
MAHLE	OC269
FRAM	PH4908
WEGA	WO560
TECFIL	
<b>MEDIDAS (mm):</b>	
<b>COMPRIMENTO</b>	
LARGURA	
ALTURA	82
D. INTERNO	89
D. EXTERNO	94
ROSCA	13/16x16
BICOS	

**HONDA**

**FO498S**



<b>OEM:</b>	
15400PH1F01 15400PH1F02	
<b>EQUIVALÊNCIAS:</b>	
MANN	W610/6
MAHLE	OC115
FRAM	PH3593A
WEGA	JFO409
TECFIL	PSL131
<b>MEDIDAS (mm):</b>	
<b>COMPRIMENTO</b>	
LARGURA	
ALTURA	92
D. INTERNO	62
D. EXTERNO	76
ROSCA	M20x1,5
BICOS	

**ASIA / MAZDA / MITSUBISHI / VOLVO**

**FO502S**



<b>OEM:</b>	
2630021010 4316591	
<b>EQUIVALÊNCIAS:</b>	
MANN	W811/80
MAHLE	
FRAM	PH3950
WEGA	JFO501
TECFIL	
<b>MEDIDAS (mm):</b>	
<b>COMPRIMENTO</b>	
LARGURA	
ALTURA	81
D. INTERNO	63
D. EXTERNO	90
ROSCA	M20x1,5
BICOS	

**HYUNDAI / KIA / MAZDA / MITSUBISHI**

**FO505P**



<b>OEM:</b>	
MD069782 2630042010	
<b>EQUIVALÊNCIAS:</b>	
MANN	WP928/81
MAHLE	OC274
FRAM	PH6355A
WEGA	JFO506
TECFIL	PSL320
<b>MEDIDAS (mm):</b>	
<b>COMPRIMENTO</b>	
LARGURA	
ALTURA	126
D. INTERNO	72
D. EXTERNO	99,7
ROSCA	M26x1,5
BICOS	

**HYUNDAI / KIA / MAZDA / MITSUBISHI**

**FO505S**



<b>OEM:</b>	
MD069782 2630042010	
<b>EQUIVALÊNCIAS:</b>	
MANN	WP928/81
MAHLE	OC274
FRAM	PH6355
WEGA	JFO505
TECFIL	PSL327
<b>MEDIDAS (mm):</b>	
<b>COMPRIMENTO</b>	
LARGURA	
ALTURA	127,4
D. INTERNO	73
D. EXTERNO	102,4
ROSCA	M26x1,5
BICOS	

**MITSUBISHI**

**FO510S**



<b>OEM:</b>	
MD322508 MD136466	
<b>EQUIVALÊNCIAS:</b>	
MANN	
MAHLE	
FRAM	PH5317
WEGA	
TECFIL	
<b>MEDIDAS (mm):</b>	
<b>COMPRIMENTO</b>	
LARGURA	
ALTURA	67
D. INTERNO	63
D. EXTERNO	80,3
ROSCA	M20x1,5
BICOS	

**HYUNDAI / KIA**

**FO593S**



<b>OEM:</b>	
2630002500 2630002501	
<b>EQUIVALÊNCIAS:</b>	
MANN	W67/1
MAHLE	OC195
FRAM	PH5343
WEGA	JFO593
TECFIL	PSL134
<b>MEDIDAS (mm):</b>	
<b>COMPRIMENTO</b>	
LARGURA	
ALTURA	77,6
D. INTERNO	64
D. EXTERNO	68
ROSCA	M20x1,5
BICOS	

**MITSUBISHI**

**FO597S**



<b>OEM:</b>	
ME013307 ME013343	
<b>EQUIVALÊNCIAS:</b>	
MANN	WP1045
MAHLE	OC297
FRAM	PH5529
WEGA	JFO597
TECFIL	PSL158
<b>MEDIDAS (mm):</b>	
<b>COMPRIMENTO</b>	
LARGURA	
ALTURA	152
D. INTERNO	71,6
D. EXTERNO	102,3
ROSCA	M26x1,5
BICOS	

**HYUNDAI / JAC / KIA**

**FO599S**



<b>OEM:</b>	
2630002750 2630035056	
<b>EQUIVALÊNCIAS:</b>	
MANN	W811/80
MAHLE	OC205
FRAM	PH3593
WEGA	JFO598
TECFIL	PSL818
<b>MEDIDAS (mm):</b>	
<b>COMPRIMENTO</b>	
LARGURA	
ALTURA	76
D. INTERNO	64
D. EXTERNO	80
ROSCA	M20x1,5
BICOS	

**DAEWOO / SUBARU / SUZUKI**

**FO601S**



<b>OEM:</b>	
1651073002 1651087203	
<b>EQUIVALÊNCIAS:</b>	
MANN	W811/81
MAHLE	OC215
FRAM	PH2951
WEGA	JFO601
TECFIL	PSL132
<b>MEDIDAS (mm):</b>	
<b>COMPRIMENTO</b>	
LARGURA	
ALTURA	77
D. INTERNO	63
D. EXTERNO	80
ROSCA	3/4"-16UNF
BICOS	



CHANA / CN AUTO / DAIHATSU / EFA / SUZUKI

### FO604S



<b>OEM:</b>	
1560187204	
1560187107	
<b>EQUIVALÊNCIAS:</b>	
MANN	W67/2
MAHLE	OC215
FRAM	PH4997
WEGA	JFO604
TECFIL	PSL134
<b>MEDIDAS (mm):</b>	
<b>COMPRIMENTO</b>	
LARGURA	
ALTURA	67
D. INTERNO	64
D. EXTERNO	68
ROSCA	3/4"x16
BICOS	

### FO699S



<b>OEM:</b>	
1109N2	
493063	
<b>EQUIVALÊNCIAS:</b>	
MANN	W712/8
MAHLE	OC100
FRAM	PH5566
WEGA	
TECFIL	PSL135
<b>MEDIDAS (mm):</b>	
<b>COMPRIMENTO</b>	
LARGURA	
ALTURA	87,4
D. INTERNO	71
D. EXTERNO	76
ROSCA	M20x1,5
BICOS	

PEUGEOT

MITSUBISHI / SUBARU

### FO703S



<b>OEM:</b>	
15400PR3004	
2630021000	
<b>EQUIVALÊNCIAS:</b>	
MANN	W814/80
MAHLE	OC115
FRAM	PH6811
WEGA	JFO301
TECFIL	PSL131
<b>MEDIDAS (mm):</b>	
<b>COMPRIMENTO</b>	
LARGURA	
ALTURA	77
D. INTERNO	63
D. EXTERNO	80
ROSCA	M20x1,5
BICOS	

### FO705S



<b>OEM:</b>	
15208AA020	
15208AA021	
<b>EQUIVALÊNCIAS:</b>	
MANN	W811/85
MAHLE	OC115
FRAM	PH3593A
WEGA	JFO705
TECFIL	PSL818
<b>MEDIDAS (mm):</b>	
<b>COMPRIMENTO</b>	
LARGURA	
ALTURA	72,7
D. INTERNO	63
D. EXTERNO	80,5
ROSCA	M20x1,5
BICOS	

SUBARU

SUBARU

### FO706S



<b>OEM:</b>	
15208AA031	
<b>EQUIVALÊNCIAS:</b>	
MANN	W811/80
MAHLE	OC500
FRAM	PH3593
WEGA	
TECFIL	
<b>MEDIDAS (mm):</b>	
<b>COMPRIMENTO</b>	
LARGURA	
ALTURA	76
D. INTERNO	62
D. EXTERNO	80
ROSCA	M20x1,5
BICOS	

### FO800S



<b>OEM:</b>	
1651083000	
1651083001	
<b>EQUIVALÊNCIAS:</b>	
MANN	W818/84
MAHLE	OC217/5
FRAM	PH2951
WEGA	JFO898
TECFIL	
<b>MEDIDAS (mm):</b>	
<b>COMPRIMENTO</b>	
LARGURA	
ALTURA	102
D. INTERNO	63
D. EXTERNO	80
ROSCA	3/4"-16UNF
BICOS	

SUZUKI

NISSAN / PEUGEOT / RENAULT

### FO891S



<b>OEM:</b>	
8200033408	
1651084CT0	
<b>EQUIVALÊNCIAS:</b>	
MANN	W75/2
MAHLE	OC309
FRAM	PH5796
WEGA	WO200
TECFIL	PSL77
<b>MEDIDAS (mm):</b>	
<b>COMPRIMENTO</b>	
LARGURA	
ALTURA	57
D. INTERNO	71,4
D. EXTERNO	76
ROSCA	M20x1,5
BICOS	

### FO898S



<b>OEM:</b>	
1651061A01	
<b>EQUIVALÊNCIAS:</b>	
MANN	W610/1
MAHLE	OC216
FRAM	PH4967
WEGA	JFO898
TECFIL	
<b>MEDIDAS (mm):</b>	
<b>COMPRIMENTO</b>	
LARGURA	
ALTURA	87
D. INTERNO	62,6
D. EXTERNO	68
ROSCA	3/4"-16UNF
BICOS	

CHEVROLET / SUZUKI

ASIA / CITROËN

### FO900S



<b>OEM:</b>	
OK41023802A	
K41023802	
<b>EQUIVALÊNCIAS:</b>	
MANN	W1035
MAHLE	OC299
FRAM	PH4853
WEGA	JFO984
TECFIL	PSL323
<b>MEDIDAS (mm):</b>	
<b>COMPRIMENTO</b>	
LARGURA	
ALTURA	127
D. INTERNO	98
D. EXTERNO	101
ROSCA	M20x1,5
BICOS	

### FO913S



<b>OEM:</b>	
04781452AA	
4781452AA	
<b>EQUIVALÊNCIAS:</b>	
MANN	
MAHLE	
FRAM	
WEGA	
TECFIL	
<b>MEDIDAS (mm):</b>	
<b>COMPRIMENTO</b>	
LARGURA	
ALTURA	122
D. INTERNO	72
D. EXTERNO	75,5
ROSCA	3/4"-16UNF
BICOS	

CHRYSLER / DODGE / FORD / JAGUAR / JEEP

**F0985S**

**LADA**



<b>OEM:</b>	
41152002A 21011012005	
<b>EQUIVALÊNCIAS:</b>	
MANN	W920/21
MAHLE	OC136
FRAM	PH2809
WEGA	
TECFIL	
<b>MEDIDAS (mm):</b>	
COMPRIMENTO	
LARGURA	
ALTURA	97
D. INTERNO	72
D. EXTERNO	94
ROSCA	3/4"-16UNF
BICOS	

**F0986S**

**ALFA ROMEO / CRYSLER / JEEP**



<b>OEM:</b>	
5281090 25322830	
<b>EQUIVALÊNCIAS:</b>	
MANN	W920/6
MAHLE	OC236
FRAM	PH16
WEGA	WO250
TECFIL	PSL171
<b>MEDIDAS (mm):</b>	
COMPRIMENTO	
LARGURA	
ALTURA	100
D. INTERNO	73
D. EXTERNO	94
ROSCA	3/4"-16UNF
BICOS	

**F0997S**

**MB / SSANGYONG**



<b>OEM:</b>	
6011800009 6011800109	
<b>EQUIVALÊNCIAS:</b>	
MANN	PF 1050/1N
MAHLE	OX38D
FRAM	CH4536
WEGA	JFO997
TECFIL	
<b>MEDIDAS (mm):</b>	
COMPRIMENTO	
LARGURA	
ALTURA	168
D. INTERNO	27/14
D. EXTERNO	82,7
ROSCA	
BICOS	

**FOH01S**

**HYUNDAI**



<b>OEM:</b>	
2631027420	
<b>EQUIVALÊNCIAS:</b>	
MANN	
MAHLE	OC1035
FRAM	
WEGA	
TECFIL	
<b>MEDIDAS (mm):</b>	
COMPRIMENTO	
LARGURA	
ALTURA	146,5
D. INTERNO	70
D. EXTERNO	89
ROSCA	3/4" x 16
BICOS	

**FOH04S**

**HYUNDAI / JEEP**



<b>OEM:</b>	
05072720AA 2632027200	
<b>EQUIVALÊNCIAS:</b>	
MANN	HU718X
MAHLE	OX384D
FRAM	CH9685
WEGA	W0E900
TECFIL	
<b>MEDIDAS (mm):</b>	
COMPRIMENTO	
LARGURA	
ALTURA	118
D. INTERNO	33
D. EXTERNO	62
ROSCA	
BICOS	

**FOK00S**

**ASIA / KIA**



<b>OEM:</b>	
0K41023802A K41023802	
<b>EQUIVALÊNCIAS:</b>	
MANN	W1035
MAHLE	OC299
FRAM	PH4826
WEGA	JFOK00
TECFIL	PSL323
<b>MEDIDAS (mm):</b>	
COMPRIMENTO	
LARGURA	
ALTURA	148
D. INTERNO	99
D. EXTERNO	102
ROSCA	M20x1,5
BICOS	

**FOK01/1S**

**ASIA / PEUGEOT**



<b>OEM:</b>	
0K80023802CH K80023802	
<b>EQUIVALÊNCIAS:</b>	
MANN	W950/35
MAHLE	OC2
FRAM	PH4826
WEGA	JFOK01/1
TECFIL	PSL325
<b>MEDIDAS (mm):</b>	
COMPRIMENTO	
LARGURA	
ALTURA	170
D. INTERNO	
D. EXTERNO	93
ROSCA	M20x1,5
BICOS	

**FOK01/2S**

**KIA**



<b>OEM:</b>	
K62023802 K67023802	
<b>EQUIVALÊNCIAS:</b>	
MANN	
MAHLE	
FRAM	PH2849A
WEGA	JFOK01/2
TECFIL	PSL324
<b>MEDIDAS (mm):</b>	
COMPRIMENTO	
LARGURA	
ALTURA	148
D. INTERNO	
D. EXTERNO	80
ROSCA	M20x1,5
BICOS	

**FOK02S**

**KIA**



<b>OEM:</b>	
46751179 2630002750	
<b>EQUIVALÊNCIAS:</b>	
MANN	
MAHLE	
FRAM	
WEGA	
TECFIL	
<b>MEDIDAS (mm):</b>	
COMPRIMENTO	
LARGURA	
ALTURA	87,3
D. INTERNO	64
D. EXTERNO	68
ROSCA	M20x1,5
BICOS	

**FOK05S**

**HYUNDAI / KIA**



<b>OEM:</b>	
263304X000	
<b>EQUIVALÊNCIAS:</b>	
MANN	W930/20
MAHLE	
FRAM	PH5596
WEGA	JFO505P
TECFIL	PSL332
<b>MEDIDAS (mm):</b>	
COMPRIMENTO	
LARGURA	
ALTURA	118
D. INTERNO	71
D. EXTERNO	94,6
ROSCA	M26x1,5
BICOS	



**FOK06S**

KIA



OEM:	
263104A000	
EQUIVALÊNCIAS:	
MANN	W933/4
MAHLE	OC526
FRAM	
WEGA	JFOK06
TECFIL	
MEDIDAS (mm):	
COMPRIMENTO	
LARGURA	
ALTURA	134
D. INTERNO	72
D. EXTERNO	93,5
ROSCA	M26x1,5
BICOS	

**FOL02S**

FORD / MB / LAND ROVER



OEM:	
ERR3340 000HS017	
EQUIVALÊNCIAS:	
MANN	W920
MAHLE	OC236
FRAM	PH5106
WEGA	WO250
TECFIL	
MEDIDAS (mm):	
COMPRIMENTO	
LARGURA	
ALTURA	110
D. INTERNO	71,7
D. EXTERNO	93,3
ROSCA	3/4" x 16
BICOS	

**FOL03S**

LAND ROVER



OEM:	
STC974 AAU8435	
EQUIVALÊNCIAS:	
MANN	W713/28
MAHLE	OC237/1
FRAM	PH4952
WEGA	WO550
TECFIL	
MEDIDAS (mm):	
COMPRIMENTO	
LARGURA	
ALTURA	94
D. INTERNO	73
D. EXTERNO	76
ROSCA	13/16 x 16
BICOS	

**FOL05S**

LAND ROVER



OEM:	
LPX100590	
EQUIVALÊNCIAS:	
MANN	W713/9
MAHLE	OC298
FRAM	PH5889
WEGA	WO561
TECFIL	
MEDIDAS (mm):	
COMPRIMENTO	
LARGURA	
ALTURA	106,5
D. INTERNO	73
D. EXTERNO	76,5
ROSCA	3/4" x 16
BICOS	

**FOL08S**

JAGUAR / LAND ROVER



OEM:	
4H236714CA 4508334	
EQUIVALÊNCIAS:	
MANN	W713/29
MAHLE	OC602
FRAM	PH9010
WEGA	WO551
TECFIL	
MEDIDAS (mm):	
COMPRIMENTO	
LARGURA	
ALTURA	108
D. INTERNO	73
D. EXTERNO	78,5
ROSCA	1-12 UNF
BICOS	

**FOM00S**

SMART



OEM:	
0003041V003 0003041V004	
EQUIVALÊNCIAS:	
MANN	HU68X
MAHLE	OX346D
FRAM	CH9024
WEGA	
TECFIL	
MEDIDAS (mm):	
COMPRIMENTO	
LARGURA	
ALTURA	54
D. INTERNO	29
D. EXTERNO	53
ROSCA	
BICOS	

**FOM01S**

SMART



OEM:	
MR984204 A0001802810	
EQUIVALÊNCIAS:	
MANN	
MAHLE	
FRAM	
WEGA	
TECFIL	
MEDIDAS (mm):	
COMPRIMENTO	
LARGURA	
ALTURA	86,5
D. INTERNO	63
D. EXTERNO	68
ROSCA	M20x1,5
BICOS	

**FOM02S**

SMART



OEM:	
1321800010 1230A040	
EQUIVALÊNCIAS:	
MANN	W6011
MAHLE	OC607
FRAM	PH11016
WEGA	JFOS00
TECFIL	
MEDIDAS (mm):	
COMPRIMENTO	
LARGURA	
ALTURA	52
D. INTERNO	63
D. EXTERNO	68
ROSCA	M20x1,5
BICOS	

**FOM03S**

SMART



OEM:	
A639184010 A6391840101	
EQUIVALÊNCIAS:	
MANN	W713/35
MAHLE	OC369
FRAM	
WEGA	
TECFIL	
MEDIDAS (mm):	
COMPRIMENTO	
LARGURA	
ALTURA	101
D. INTERNO	71,6
D. EXTERNO	76
ROSCA	M20x1,5
BICOS	

**FOMT01S**

MOTO



OEM:	
15412KF000	
EQUIVALÊNCIAS:	
MANN	MH54X
MAHLE	OX410/D
FRAM	CH6015
WEGA	JFO0014
TECFIL	PL153
MEDIDAS (mm):	
COMPRIMENTO	
LARGURA	
ALTURA	32
D. INTERNO	13
D. EXTERNO	40
ROSCA	
BICOS	

**FOMT02S**



**OEM:**  
15410MCJ003

**EQUIVALÊNCIAS:**

MANN	MW64
MAHLE	OC575
FRAM	
WEGA	JFO411
TECFIL	PSL638

**MEDIDAS (mm):**

COMPRIMENTO	
LARGURA	
ALTURA	72
D. INTERNO	
D. EXTERNO	65
ROSCA	M20x1,5
BICOS	

MOTO

**FOMT03S**



**OEM:**  
1651016B00

**EQUIVALÊNCIAS:**

MANN	MW65
MAHLE	OC574
FRAM	
WEGA	JFO890
TECFIL	

**MEDIDAS (mm):**

COMPRIMENTO	
LARGURA	
ALTURA	66
D. INTERNO	
D. EXTERNO	67
ROSCA	M20x1,0
BICOS	

MOTO

**FOMT04S**



**OEM:**  
2630002501

**EQUIVALÊNCIAS:**

MANN	MW67/1
MAHLE	OC1018
FRAM	
WEGA	JFO593
TECFIL	

**MEDIDAS (mm):**

COMPRIMENTO	
LARGURA	
ALTURA	76
D. INTERNO	
D. EXTERNO	68
ROSCA	M20x1,5
BICOS	

MOTO

**FOW02S**



**OEM:**  
25181616  
96475855

**EQUIVALÊNCIAS:**

MANN	
MAHLE	
FRAM	
WEGA	
TECFIL	

**MEDIDAS (mm):**

COMPRIMENTO	
LARGURA	
ALTURA	72
D. INTERNO	63
D. EXTERNO	68
ROSCA	M18x1,5
BICOS	

CHEVROLET

**FOBR1S**



**OEM:**  
89017524  
04892339AA

**EQUIVALÊNCIAS:**

MANN	ML1030
MAHLE	OC614
FRAM	PH10060
WEGA	WO133
TECFIL	PSL615

**MEDIDAS (mm):**

COMPRIMENTO	
LARGURA	
ALTURA	84
D. INTERNO	
D. EXTERNO	75
ROSCA	M22x1,5
BICOS	

CADILLAC / CHEVROLET / DODGE / FIAT

**FOBR2S**



**OEM:**  
7700860823  
98472349

**EQUIVALÊNCIAS:**

MANN	WP1144
MAHLE	OC248
FRAM	PH4847
WEGA	WO330
TECFIL	PSL156

**MEDIDAS (mm):**

COMPRIMENTO	
LARGURA	
ALTURA	145
D. INTERNO	
D. EXTERNO	109
ROSCA	3/4"X16UNF-2B
BICOS	

CITROËN / FIAT / IVECO

**FOBR3S**



**OEM:**  
152086S300  
905411880018

**EQUIVALÊNCIAS:**

MANN	W1323
MAHLE	OC404
FRAM	PH9503
WEGA	WO540
TECFIL	PSL340

**MEDIDAS (mm):**

COMPRIMENTO	
LARGURA	
ALTURA	97
D. INTERNO	100
D. EXTERNO	139
ROSCA	11/2"x16UNF-2B
BICOS	

AGRALE / CHEVROLET / NISSAN / TROLLER

**FOBR4S**



**OEM:**  
F1AZ6731BD  
F1AE6714BC

**EQUIVALÊNCIAS:**

MANN	W920/45
MAHLE	OC288
FRAM	PH2
WEGA	WO261
TECFIL	

**MEDIDAS (mm):**

COMPRIMENTO	
LARGURA	
ALTURA	91
D. INTERNO	55
D. EXTERNO	93
ROSCA	M22x1,5
BICOS	

CHRYSLER / DODGE / FORD / JEEP

**FOBR5S**



**OEM:**  
030115561P  
030115561K

**EQUIVALÊNCIAS:**

MANN	W712/53
MAHLE	OC250
FRAM	PH5548
WEGA	WO340
TECFIL	PSL560

**MEDIDAS (mm):**

COMPRIMENTO	
LARGURA	
ALTURA	102
D. INTERNO	62,9
D. EXTERNO	76,8
ROSCA	3/4"X16unf
BICOS	

VW

**FOBR6S**



**OEM:**  
504091563  
2995811

**EQUIVALÊNCIAS:**

MANN	W914/28
MAHLE	OC616
FRAM	PH10268
WEGA	WO421
TECFIL	PSL657

**MEDIDAS (mm):**

COMPRIMENTO	
LARGURA	
ALTURA	78
D. INTERNO	
D. EXTERNO	96
ROSCA	M22x1,5
BICOS	

CITROËN / FIAT / PEUGEOT



**IVECO**

**FOBR7S**



OEM:	
2995655	
MK666096	
EQUIVALÊNCIAS:	
MANN	W940/69
MAHLE	OC613
FRAM	
WEGA	WO331
TECFIL	PSL655
MEDIDAS (mm):	
COMPRIMENTO	
LARGURA	
ALTURA	142
D. INTERNO	
D. EXTERNO	96
ROSCA	M22x1,5
BICOS	

**FORD**

**FOBR8S**



OEM:	
XS6E6714C1A	
1026285	
EQUIVALÊNCIAS:	
MANN	W712/43
MAHLE	OC235
FRAM	PH5713
WEGA	WO150
TECFIL	PSL145
MEDIDAS (mm):	
COMPRIMENTO	
LARGURA	
ALTURA	72
D. INTERNO	62
D. EXTERNO	76
ROSCA	3/4"x16UNF-2B
BICOS	

**CITROËN / PEUGEOT / RENAULT**

**FOBR9S**



OEM:	
1109N2	
493063	
EQUIVALÊNCIAS:	
MANN	W712/8
MAHLE	OC100
FRAM	PH5566
WEGA	WO160
TECFIL	PSL135
MEDIDAS (mm):	
COMPRIMENTO	
LARGURA	
ALTURA	87,5
D. INTERNO	62
D. EXTERNO	76
ROSCA	M20x1,5
BICOS	

**FORD / LAND ROVER**

**FOBR10S**



OEM:	
04781452AA	
4781452AA	
EQUIVALÊNCIAS:	
MANN	W719/27
MAHLE	OC266
FRAM	PH5803
WEGA	WO180
TECFIL	PSL144
MEDIDAS (mm):	
COMPRIMENTO	
LARGURA	
ALTURA	125
D. INTERNO	70
D. EXTERNO	76
ROSCA	3/4"-16UNF
BICOS	

**AUDI / FORD / SEAT**

**FOBR12S**



OEM:	
261155612	
561155611	
EQUIVALÊNCIAS:	
MANN	W719/5
MAHLE	OC47
FRAM	PH2870A
WEGA	WO370
TECFIL	PSI561
MEDIDAS (mm):	
COMPRIMENTO	
LARGURA	
ALTURA	118
D. INTERNO	62
D. EXTERNO	76
ROSCA	3/4"-16UNF-2B
BICOS	

**ALFA ROMEO / FIAT**

**FOBR13S**



OEM:	
82360558	
82361657	
EQUIVALÊNCIAS:	
MANN	W920/31
MAHLE	OC23
FRAM	PH2863
WEGA	WO460
TECFIL	PSL47
MEDIDAS (mm):	
COMPRIMENTO	
LARGURA	
ALTURA	94,5
D. INTERNO	62
D. EXTERNO	93,2
ROSCA	3/4"-16UNF-2B
BICOS	

**CHEVROLET**

**FOBR14S**



OEM:	
25010908	
25012760	
EQUIVALÊNCIAS:	
MANN	W719/31
MAHLE	OC81
FRAM	PH3980
WEGA	WO530
TECFIL	PSL620
MEDIDAS (mm):	
COMPRIMENTO	
LARGURA	
ALTURA	118
D. INTERNO	62
D. EXTERNO	76
ROSCA	M18x1,5
BICOS	

**ALFA ROMEO / FIAT**

**FOBR15S**



OEM:	
46787007	
50008507	
EQUIVALÊNCIAS:	
MANN	W713/16
MAHLE	OC66
FRAM	PH4558
WEGA	WO170
TECFIL	PSL45
MEDIDAS (mm):	
COMPRIMENTO	
LARGURA	
ALTURA	93,5
D. INTERNO	62
D. EXTERNO	76
ROSCA	M20x1,5
BICOS	

**CHEVROLET**

**FOBR16S**



OEM:	
93312933	
EQUIVALÊNCIAS:	
MANN	W75/5
MAHLE	OC728
FRAM	PH9648
WEGA	WO131
TECFIL	
MEDIDAS (mm):	
COMPRIMENTO	
LARGURA	
ALTURA	60
D. INTERNO	62
D. EXTERNO	76
ROSCA	M18x1,5-6H
BICOS	

**FORD / VW**

**FOBR17S**



OEM:	
90AU6714AA	
90VU6714AA	
EQUIVALÊNCIAS:	
MANN	W915/9
MAHLE	OC300
FRAM	PH927A
WEGA	WO240
TECFIL	PSL565
MEDIDAS (mm):	
COMPRIMENTO	
LARGURA	
ALTURA	65
D. INTERNO	76
D. EXTERNO	95
ROSCA	
BICOS	

**FOBR18S**

**FORD**



<b>OEM:</b>	
BG8T6731AA	
<b>EQUIVALÊNCIAS:</b>	
MANN	W719/50
MAHLE	OC1055
FRAM	
WEGA	WO541
TECFIL	PSL541
<b>MEDIDAS (mm):</b>	
<b>COMPRIMENTO</b>	
LARGURA	
ALTURA	137,3
D. INTERNO	
D. EXTERNO	76
ROSCA	3/4"-16UNF-2B
BICOS	

**FOBR19S**

**VW CAMINHÕES**



<b>OEM:</b>	
3401544	
<b>EQUIVALÊNCIAS:</b>	
MANN	WP12121
MAHLE	OC482
FRAM	PH11009
WEGA	WO711
TECFIL	PSL909
<b>MEDIDAS (mm):</b>	
<b>COMPRIMENTO</b>	
LARGURA	
ALTURA	302
D. INTERNO	102
D. EXTERNO	118
ROSCA	21/4"-12UNS
BICOS	

**FOBR20S**

**IVECO CAMINHÕES**



<b>OEM:</b>	
1903629 1903715	
<b>EQUIVALÊNCIAS:</b>	
MANN	WP1169
MAHLE	OC267
FRAM	PH5103
WEGA	WO600
TECFIL	
<b>MEDIDAS (mm):</b>	
<b>COMPRIMENTO</b>	
LARGURA	
ALTURA	213
D. INTERNO	93
D. EXTERNO	108
ROSCA	M30x2,0
BICOS	

**FOBR21S**

**ASIA / CHEVROLET / PEUGEOT**



<b>OEM:</b>	
7700730077 770730077	
<b>EQUIVALÊNCIAS:</b>	
MANN	W920/25
MAHLE	OC223
FRAM	PH2992
WEGA	WO500
TECFIL	PSL321
<b>MEDIDAS (mm):</b>	
<b>COMPRIMENTO</b>	
LARGURA	
ALTURA	95
D. INTERNO	
D. EXTERNO	96
ROSCA	M20x1,5
BICOS	

**FOBR22S**

**CHEVROLET**



<b>OEM:</b>	
7323959 5578052	
<b>EQUIVALÊNCIAS:</b>	
MANN	W936/8
MAHLE	OC114
FRAM	PH13
WEGA	WO510
TECFIL	PSL959
<b>MEDIDAS (mm):</b>	
<b>COMPRIMENTO</b>	
LARGURA	
ALTURA	139
D. INTERNO	76
D. EXTERNO	93
ROSCA	13/16-16UN
BICOS	

**FOBR23S**

**CHEVROLET / FORD**



<b>OEM:</b>	
BF5T6731A	
<b>EQUIVALÊNCIAS:</b>	
MANN	W923/1
MAHLE	OC261
FRAM	PH5443
WEGA	WO290
TECFIL	PSL902
<b>MEDIDAS (mm):</b>	
<b>COMPRIMENTO</b>	
LARGURA	
ALTURA	110
D. INTERNO	62
D. EXTERNO	93
ROSCA	3/4"-16UNF-2B
BICOS	

**FOBR24S**

**CHEVROLET / FORD**



<b>OEM:</b>	
9558048280 1160025DUT	
<b>EQUIVALÊNCIAS:</b>	
MANN	W962
MAHLE	OC60
FRAM	PH2801B
WEGA	WO480
TECFIL	PSL962
<b>MEDIDAS (mm):</b>	
<b>COMPRIMENTO</b>	
LARGURA	
ALTURA	212
D. INTERNO	62
D. EXTERNO	93
ROSCA	1"x12UNF-2B
BICOS	

**FOBR25S**

**DODGE / FORD / JEEP**



<b>OEM:</b>	
ZZC423802 AA5Z6714A	
<b>EQUIVALÊNCIAS:</b>	
MANN	
MAHLE	
FRAM	PH10575
WEGA	WO151
TECFIL	
<b>MEDIDAS (mm):</b>	
<b>COMPRIMENTO</b>	
LARGURA	
ALTURA	105
D. INTERNO	
D. EXTERNO	75
ROSCA	M22x1,5-6H
BICOS	

**FOBR26S**

**VOLVO**



<b>OEM:</b>	
LF10143029A 1218846	
<b>EQUIVALÊNCIAS:</b>	
MANN	W712/73
MAHLE	OC466
FRAM	PH9566
WEGA	WO140
TECFIL	
<b>MEDIDAS (mm):</b>	
<b>COMPRIMENTO</b>	
LARGURA	
ALTURA	93
D. INTERNO	62
D. EXTERNO	76
ROSCA	3/4"-16UNF
BICOS	

**FOBR30S**

**LEXUS / TOYOTA**



<b>OEM:</b>	
04152YZZA1 415231090	
<b>EQUIVALÊNCIAS:</b>	
MANN	ML1031
MAHLE	OX413D1
FRAM	CH9972
WEGA	WOE802
TECFIL	
<b>MEDIDAS (mm):</b>	
<b>COMPRIMENTO</b>	
LARGURA	
ALTURA	65
D. INTERNO	27
D. EXTERNO	70
ROSCA	
BICOS	



**FOBR31S**

**AUDI / VW**



<b>OEM:</b>	
06H115403 06J115561B	
<b>EQUIVALÊNCIAS:</b>	
MANN	W719/45
MAHLE	OC456
FRAM	
WEGA	WO592
TECFIL	
<b>MEDIDAS (mm):</b>	
<b>COMPRIMENTO</b>	
LARGURA	
ALTURA	123
D. INTERNO	62
D. EXTERNO	76
ROSCA	M27 x 1,5
BICOS	

**FOBR32S**

**DODGE / FORD CAMINHÕES**



<b>OEM:</b>	
3903264 3932217	
<b>EQUIVALÊNCIAS:</b>	
MANN	W950/18
MAHLE	OC320
FRAM	PH3976
WEGA	WO680
TECFIL	PSL280
<b>MEDIDAS (mm):</b>	
<b>COMPRIMENTO</b>	
LARGURA	
ALTURA	170
D. INTERNO	62
D. EXTERNO	93
ROSCA	1-16UN
BICOS	

**FOBR33S**

**FORD CAMINHÕES**



<b>OEM:</b>	
3318853 1288430	
<b>EQUIVALÊNCIAS:</b>	
MANN	WP12300
MAHLE	OC482
FRAM	HPH6349A
WEGA	WO710
TECFIL	PSL300
<b>MEDIDAS (mm):</b>	
<b>COMPRIMENTO</b>	
LARGURA	
ALTURA	294
D. INTERNO	104
D. EXTERNO	118
ROSCA	2 1/4"-12UN
BICOS	

**FOBR34S**

**HYUNDAI / KIA**



<b>OEM:</b>	
263203CAA0	
<b>EQUIVALÊNCIAS:</b>	
MANN	OX417D
MAHLE	CH10855
FRAM	CH10855
WEGA	WOE913
TECFIL	
<b>MEDIDAS (mm):</b>	
<b>COMPRIMENTO</b>	
LARGURA	
ALTURA	117,5
D. INTERNO	36/26
D. EXTERNO	71,5
ROSCA	
BICOS	

**FOBR35S**

**CHEVROLET / FORD**



<b>OEM:</b>	
71054 DNONN6714A	
<b>EQUIVALÊNCIAS:</b>	
MANN	W940/1
MAHLE	OC324
FRAM	PH2821C
WEGA	WO280
TECFIL	PSL900
<b>MEDIDAS (mm):</b>	
<b>COMPRIMENTO</b>	
LARGURA	
ALTURA	142
D. INTERNO	62,5
D. EXTERNO	93
ROSCA	3/4"
BICOS	

**FOBR36S**

**FORD**



<b>OEM:</b>	
8511220031 6005000929	
<b>EQUIVALÊNCIAS:</b>	
MANN	W940/18
MAHLE	OC26
FRAM	PH36
WEGA	WO470
TECFIL	PSL123
<b>MEDIDAS (mm):</b>	
<b>COMPRIMENTO</b>	
LARGURA	
ALTURA	142
D. INTERNO	62
D. EXTERNO	93
ROSCA	1" x 12 UNF - 2B
BICOS	

**FOBR37S**

**VOLVO CAMINHÕES**



<b>OEM:</b>	
6439392 IR0739	
<b>EQUIVALÊNCIAS:</b>	
MANN	W11102/4
MAHLE	OC121
FRAM	PH4849
WEGA	WO630
TECFIL	PSL417
<b>MEDIDAS (mm):</b>	
<b>COMPRIMENTO</b>	
LARGURA	
ALTURA	260,4
D. INTERNO	91
D. EXTERNO	108
ROSCA	
BICOS	

**FOBR38S**

**MB CAMINHÕES**



<b>OEM:</b>	
31843301 12709262	
<b>EQUIVALÊNCIAS:</b>	
MANN	W1168/5
MAHLE	OC303
FRAM	PH7136
WEGA	WO650
TECFIL	PSL301
<b>MEDIDAS (mm):</b>	
<b>COMPRIMENTO</b>	
LARGURA	
ALTURA	184
D. INTERNO	62,6
D. EXTERNO	108
ROSCA	
BICOS	

**FOBR39S**

**SCANIA CAMINHÕES**



<b>OEM:</b>	
1498021 7961367	
<b>EQUIVALÊNCIAS:</b>	
MANN	W920/7
MAHLE	OC18
FRAM	PH5106
WEGA	
TECFIL	PSL171
<b>MEDIDAS (mm):</b>	
<b>COMPRIMENTO</b>	
LARGURA	
ALTURA	95
D. INTERNO	62
D. EXTERNO	93
ROSCA	
BICOS	

**FOBR40S**

**CHEVROLET**



<b>OEM:</b>	
7323958	
<b>EQUIVALÊNCIAS:</b>	
MANN	W930/6
MAHLE	OC301
FRAM	PH2845
WEGA	WO741
TECFIL	PSL958
<b>MEDIDAS (mm):</b>	
<b>COMPRIMENTO</b>	
LARGURA	
ALTURA	127
D. INTERNO	76
D. EXTERNO	93
ROSCA	
BICOS	

**FOBR41S**

**AUDI / VW**



<b>OEM:</b>	
034115561AA 06A115561	
<b>EQUIVALÊNCIAS:</b>	
MANN	W719/30
MAHLE	OC264
FRAM	PH5552
WEGA	WO181
TECFIL	PSL564
<b>MEDIDAS (mm):</b>	
COMPRIMENTO	
LARGURA	
ALTURA	123
D. INTERNO	62
D. EXTERNO	76
ROSCA	3/4" - 16UNF
BICOS	

**FOBR42S**

**VW**



<b>OEM:</b>	
07Z115466A 07Z115562	
<b>EQUIVALÊNCIAS:</b>	
MANN	
MAHLE	OX556D
FRAM	CH9813
WEGA	
TECFIL	
<b>MEDIDAS (mm):</b>	
COMPRIMENTO	
LARGURA	
ALTURA	144
D. INTERNO	34
D. EXTERNO	91,5
ROSCA	
BICOS	

**FOBR43S**

**CHRYSLER / DODGE / JEEP**



<b>OEM:</b>	
68079744AA 68079744AA	
<b>EQUIVALÊNCIAS:</b>	
MANN	
MAHLE	OX786D
FRAM	CH10955
WEGA	
TECFIL	
<b>MEDIDAS (mm):</b>	
COMPRIMENTO	
LARGURA	
ALTURA	137,5
D. INTERNO	22
D. EXTERNO	52
ROSCA	
BICOS	

**FOBR44S**

**FORD**



<b>OEM:</b>	
AA6E6714AA 7STG6714AA	
<b>EQUIVALÊNCIAS:</b>	
MANN	
MAHLE	
FRAM	
WEGA	WO153
TECFIL	
<b>MEDIDAS (mm):</b>	
COMPRIMENTO	
LARGURA	
ALTURA	85
D. INTERNO	
D. EXTERNO	76,5
ROSCA	3/4"
BICOS	

**FOBR45S**

**CHEVROLET**



<b>OEM:</b>	
12636838	
<b>EQUIVALÊNCIAS:</b>	
MANN	
MAHLE	
FRAM	
WEGA	W0E314
TECFIL	
<b>MEDIDAS (mm):</b>	
COMPRIMENTO	
LARGURA	
ALTURA	162,5
D. INTERNO	28/16,7
D. EXTERNO	64
ROSCA	
BICOS	

**FOBR46S**

**DODGE / JEEP**



<b>OEM:</b>	
5184231AA 1-05184231AA	
<b>EQUIVALÊNCIAS:</b>	
MANN	
MAHLE	
FRAM	PH10590
WEGA	JFO989
TECFIL	
<b>MEDIDAS (mm):</b>	
COMPRIMENTO	
LARGURA	
ALTURA	120
D. INTERNO	
D. EXTERNO	72
ROSCA	M22x1,5 - 6H
BICOS	

**FOBR47S**

**TOYOTA**



<b>OEM:</b>	
90915TA0015	
<b>EQUIVALÊNCIAS:</b>	
MANN	
MAHLE	
FRAM	
WEGA	
TECFIL	
<b>MEDIDAS (mm):</b>	
COMPRIMENTO	
LARGURA	
ALTURA	63
D. INTERNO	54,5
D. EXTERNO	
ROSCA	3/4"
BICOS	

**FOBR48S**

**AUDI**



<b>OEM:</b>	
03C115561D	
<b>EQUIVALÊNCIAS:</b>	
MANN	W712/91
MAHLE	OC593/3
FRAM	PH10757
WEGA	WQ342
TECFIL	
<b>MEDIDAS (mm):</b>	
COMPRIMENTO	
LARGURA	
ALTURA	79
D. INTERNO	
D. EXTERNO	76
ROSCA	3/4"-16UNF
BICOS	

**FOBR49S**

**KIA**



<b>OEM:</b>	
NK41023802A	
<b>EQUIVALÊNCIAS:</b>	
MANN	
MAHLE	
FRAM	
WEGA	
TECFIL	PSL330
<b>MEDIDAS (mm):</b>	
COMPRIMENTO	
LARGURA	
ALTURA	137
D. INTERNO	
D. EXTERNO	95,5
ROSCA	M20x1,5
BICOS	

**FOBR50S**

**BMW**



<b>OEM:</b>	
11427580676 11427583220	
<b>EQUIVALÊNCIAS:</b>	
MANN	HU8007Z
MAHLE	OX353/7D
FRAM	
WEGA	W0E251
TECFIL	
<b>MEDIDAS (mm):</b>	
COMPRIMENTO	
LARGURA	
ALTURA	110
D. INTERNO	29
D. EXTERNO	75
ROSCA	
BICOS	



**FOBR51S**

JAGUAR / LAND ROVER



OEM:	
LR011279 C2D3670	
EQUIVALÊNCIAS:	
MANN	HU8008Z
MAHLE	OX774D
FRAM	
WEGA	
TECFIL	
MEDIDAS (mm):	
COMPRIMENTO	
LARGURA	
ALTURA	153
D. INTERNO	25,2
D. EXTERNO	75
ROSCA	
BICOS	

**FOBR52S**

MB



OEM:	
2761800009 2761840025	
EQUIVALÊNCIAS:	
MANN	
MAHLE	OX814D
FRAM	CH11060
WEGA	WOE454
TECFIL	
MEDIDAS (mm):	
COMPRIMENTO	
LARGURA	
ALTURA	166
D. INTERNO	24,5
D. EXTERNO	64,8
ROSCA	
BICOS	

**FOBR54S**

PORSCHE



OEM:	
94810722200	
EQUIVALÊNCIAS:	
MANN	HU9001X
MAHLE	OX254D4
FRAM	
WEGA	WOE890
TECFIL	
MEDIDAS (mm):	
COMPRIMENTO	
LARGURA	
ALTURA	108
D. INTERNO	38
D. EXTERNO	83
ROSCA	
BICOS	

**FOBR55S**

MB



OEM:	
1021800109 1021840325	
EQUIVALÊNCIAS:	
MANN	H614N
MAHLE	OX34D
FRAM	CH4797
WEGA	
TECFIL	
MEDIDAS (mm):	
COMPRIMENTO	
LARGURA	
ALTURA	106
D. INTERNO	9/19
D. EXTERNO	59
ROSCA	
BICOS	

**FOBR56S**

MB



OEM:	
0001800309 0001800509	
EQUIVALÊNCIAS:	
MANN	H929X
MAHLE	OX32D
FRAM	CH4748
WEGA	WEO0511
TECFIL	
MEDIDAS (mm):	
COMPRIMENTO	
LARGURA	
ALTURA	121
D. INTERNO	23,4
D. EXTERNO	84
ROSCA	
BICOS	

**FOBR57S**

MB



OEM:	
1191800009 1191801510	
EQUIVALÊNCIAS:	
MANN	H829/1X
MAHLE	OX92D
FRAM	CH6847
WEGA	WEO0591/1
TECFIL	
MEDIDAS (mm):	
COMPRIMENTO	
LARGURA	
ALTURA	155
D. INTERNO	22/9,5
D. EXTERNO	71
ROSCA	
BICOS	

**FOBR58S**

VW



OEM:	
021115562 021115561A	
EQUIVALÊNCIAS:	
MANN	H932/5X
MAHLE	OX99
FRAM	CH5478
WEGA	WEO0600
TECFIL	
MEDIDAS (mm):	
COMPRIMENTO	
LARGURA	
ALTURA	106
D. INTERNO	23/30
D. EXTERNO	84
ROSCA	
BICOS	

**FOBR59S**

BMW



OEM:	
11427605342 11427611969	
EQUIVALÊNCIAS:	
MANN	HU7003X
MAHLE	OX825D
FRAM	
WEGA	
TECFIL	
MEDIDAS (mm):	
COMPRIMENTO	
LARGURA	
ALTURA	82
D. INTERNO	31
D. EXTERNO	64
ROSCA	
BICOS	

**FOBR60S**

BMW



OEM:	
11421712698	
EQUIVALÊNCIAS:	
MANN	H952X
MAHLE	OX121D
FRAM	CH6846
WEGA	
TECFIL	
MEDIDAS (mm):	
COMPRIMENTO	
LARGURA	
ALTURA	193
D. INTERNO	28
D. EXTERNO	83
ROSCA	
BICOS	

**FOBR61S**

MB



OEM:	
0001802209 0001802309	
EQUIVALÊNCIAS:	
MANN	HU718/5X
MAHLE	OX345/7D
FRAM	CH8902
WEGA	
TECFIL	
MEDIDAS (mm):	
COMPRIMENTO	
LARGURA	
ALTURA	115
D. INTERNO	31
D. EXTERNO	64
ROSCA	
BICOS	

**FOBR62S**

**AUDI**



<b>OEM:</b>	
068115561F	
<b>EQUIVALÊNCIAS:</b>	
MANN	W940/66
MAHLE	OC470
FRAM	PH3569A
WEGA	WO343
TECFIL	
<b>MEDIDAS (mm):</b>	
COMPRIMENTO	
LARGURA	
ALTURA	150
D. INTERNO	63/72
D. EXTERNO	93
ROSCA	3/4"X16unf
BICOS	

**FOBR63S**

**AUDI / VW**



<b>OEM:</b>	
078115561J	
<b>EQUIVALÊNCIAS:</b>	
MANN	W930/21
MAHLE	OC485
FRAM	PH5833
WEGA	WO344
TECFIL	
<b>MEDIDAS (mm):</b>	
COMPRIMENTO	
LARGURA	
ALTURA	114
D. INTERNO	62/71
D. EXTERNO	93
ROSCA	3/4"-16
BICOS	

**FOBR64S**

**FORD**



<b>OEM:</b>	
BB3Q6744BA	
<b>EQUIVALÊNCIAS:</b>	
MANN	
MAHLE	
FRAM	
WEGA	WOE131
TECFIL	
<b>MEDIDAS (mm):</b>	
COMPRIMENTO	
LARGURA	
ALTURA	69
D. INTERNO	32
D. EXTERNO	64
ROSCA	
BICOS	

**FOBR65S**

**FORD**



<b>OEM:</b>	
3908616	
<b>EQUIVALÊNCIAS:</b>	
MANN	W940/34
MAHLE	OC333
FRAM	PH3900
WEGA	WO670
TECFIL	PSL282
<b>MEDIDAS (mm):</b>	
COMPRIMENTO	
LARGURA	
ALTURA	138
D. INTERNO	
D. EXTERNO	92,7
ROSCA	1"x16UN-2B
BICOS	

**FOBR66S**

**FORD**



<b>OEM:</b>	
4897898 2992242	
<b>EQUIVALÊNCIAS:</b>	
MANN	W950/56
MAHLE	OC502
FRAM	PH9617
WEGA	WO612
TECFIL	PSL283
<b>MEDIDAS (mm):</b>	
COMPRIMENTO	
LARGURA	
ALTURA	174,5
D. INTERNO	
D. EXTERNO	93,5
ROSCA	M27x2
BICOS	

**FOBR67S**

**FORD / MB**



<b>OEM:</b>	
9W7Z6731A	
<b>EQUIVALÊNCIAS:</b>	
MANN	
MAHLE	
FRAM	
WEGA	
TECFIL	
<b>MEDIDAS (mm):</b>	
COMPRIMENTO	
LARGURA	
ALTURA	90
D. INTERNO	60,7
D. EXTERNO	76
ROSCA	3/4"
BICOS	

**FOECO001**

**MB CAMINHÕES**



<b>OEM:</b>	
5411800009 5411800209	
<b>EQUIVALÊNCIAS:</b>	
MANN	HU12140X
MAHLE	OX168D
FRAM	CH5933ECO
WEGA	WOE420
TECFIL	PEL2001
<b>MEDIDAS (mm):</b>	
COMPRIMENTO	
LARGURA	
ALTURA	313
D. INTERNO	56
D. EXTERNO	117
ROSCA	
BICOS	

**FOECO003**

**MB**



<b>OEM:</b>	
1661800009 1840525	
<b>EQUIVALÊNCIAS:</b>	
MANN	HU610X
MAHLE	OX135/1D
FRAM	CH8776ECO
WEGA	WOE410
TECFIL	PEL109
<b>MEDIDAS (mm):</b>	
COMPRIMENTO	
LARGURA	
ALTURA	79
D. INTERNO	20
D. EXTERNO	52,5
ROSCA	
BICOS	

**FOECO004**

**BMW**



<b>OEM:</b>	
11421432097 11421716121	
<b>EQUIVALÊNCIAS:</b>	
MANN	HU715/4X
MAHLE	OX127/1D
FRAM	CH8087
WEGA	WOE230
TECFIL	
<b>MEDIDAS (mm):</b>	
COMPRIMENTO	
LARGURA	
ALTURA	105
D. INTERNO	21
D. EXTERNO	65
ROSCA	
BICOS	

**FOECO005**

**PORSCHE**



<b>OEM:</b>	
99610722552 99610722553	
<b>EQUIVALÊNCIAS:</b>	
MANN	HU719/5X
MAHLE	OX128/1D
FRAM	CH8278
WEGA	WOE631
TECFIL	
<b>MEDIDAS (mm):</b>	
COMPRIMENTO	
LARGURA	
ALTURA	115
D. INTERNO	28
D. EXTERNO	65
ROSCA	
BICOS	



**CHRYSLER / LAND ROVER / MB**

### FOECO006



<b>OEM:</b>	
1121840025 5086301AA	
<b>EQUIVALÊNCIAS:</b>	
MANN	HU718/1X
MAHLE	OX153/7D
FRAM	
WEGA	WOE300/2
TECFIL	
<b>MEDIDAS (mm):</b>	
COMPRIMENTO	
LARGURA	
ALTURA	115
D. INTERNO	27
D. EXTERNO	65
ROSCA	
BICOS	

**MB / SSANGYONG**

### FOECO009



<b>OEM:</b>	
1041800109 1621803009	
<b>EQUIVALÊNCIAS:</b>	
MANN	HU727/1X
MAHLE	OX133D
FRAM	CH6848
WEGA	WOE430
TECFIL	
<b>MEDIDAS (mm):</b>	
COMPRIMENTO	
LARGURA	
ALTURA	161
D. INTERNO	18,5
D. EXTERNO	62
ROSCA	
BICOS	

**LAND ROVER**

### FOECO011



<b>OEM:</b>	
11422246131	
<b>EQUIVALÊNCIAS:</b>	
MANN	HU848/1X
MAHLE	OX126DECO
FRAM	CH5979ECO
WEGA	WOE210
TECFIL	
<b>MEDIDAS (mm):</b>	
COMPRIMENTO	
LARGURA	
ALTURA	165
D. INTERNO	33
D. EXTERNO	83
ROSCA	
BICOS	

**BMW / LAND ROVER / VOLVO**

### FOECO012



<b>OEM:</b>	
11421427908 11421740534	
<b>EQUIVALÊNCIAS:</b>	
MANN	HU925/4X
MAHLE	OX154/1D
FRAM	CH8081
WEGA	WOE220
TECFIL	
<b>MEDIDAS (mm):</b>	
COMPRIMENTO	
LARGURA	
ALTURA	106
D. INTERNO	38
D. EXTERNO	83
ROSCA	
BICOS	

**AUDI / JEEP / PORSCHE / VW**

### FOECO013



<b>OEM:</b>	
021115562A 021115561B	
<b>EQUIVALÊNCIAS:</b>	
MANN	HU932/6N
MAHLE	OX160D
FRAM	CH8158
WEGA	WOE620
TECFIL	
<b>MEDIDAS (mm):</b>	
COMPRIMENTO	
LARGURA	
ALTURA	113
D. INTERNO	36 / 20
D. EXTERNO	83
ROSCA	
BICOS	

**BMW**

### FOECO014



<b>OEM:</b>	
11421745390 LPW000010	
<b>EQUIVALÊNCIAS:</b>	
MANN	HU938/4X
MAHLE	OX152/1D
FRAM	CH8213ECO
WEGA	WOE240
TECFIL	
<b>MEDIDAS (mm):</b>	
COMPRIMENTO	
LARGURA	
ALTURA	161
D. INTERNO	36 / 25
D. EXTERNO	86,6
ROSCA	
BICOS	

**RENAULT**

### FOECO015



<b>OEM:</b>	
51055040096 02931093	
<b>EQUIVALÊNCIAS:</b>	
MANN	HU947/2X
MAHLE	OX155D
FRAM	
WEGA	
TECFIL	
<b>MEDIDAS (mm):</b>	
COMPRIMENTO	
LARGURA	
ALTURA	216
D. INTERNO	36
D. EXTERNO	83
ROSCA	
BICOS	

**CHEVROLET / PONTIAC**

### FOECO019



<b>OEM:</b>	
21018801 90537280	
<b>EQUIVALÊNCIAS:</b>	
MANN	HU69/2X
MAHLE	OX258
FRAM	CH9018
WEGA	WOE312
TECFIL	
<b>MEDIDAS (mm):</b>	
COMPRIMENTO	
LARGURA	
ALTURA	90
D. INTERNO	28,5
D. EXTERNO	62
ROSCA	
BICOS	

**MB CAMINHÕES**

### FOECO020



<b>OEM:</b>	
9041800009 9041800210	
<b>EQUIVALÊNCIAS:</b>	
MANN	HU931/5X
MAHLE	OX161D
FRAM	CH8751
WEGA	WOE440
TECFIL	PEL2003
<b>MEDIDAS (mm):</b>	
COMPRIMENTO	
LARGURA	
ALTURA	152
D. INTERNO	35 / 9
D. EXTERNO	83,2
ROSCA	
BICOS	

**JEEP / MB**

### FOECO021



<b>OEM:</b>	
6111800009 0011849425	
<b>EQUIVALÊNCIAS:</b>	
MANN	HU718/1K
MAHLE	OX153D3
FRAM	CH9301ECO
WEGA	WOE300/1
TECFIL	PEL311
<b>MEDIDAS (mm):</b>	
COMPRIMENTO	
LARGURA	
ALTURA	116
D. INTERNO	31
D. EXTERNO	64
ROSCA	
BICOS	

**FOECO023**

**AUDI / VW**

**OEM:**  
045115466  
045118466

**EQUIVALÊNCIAS:**

MANN	HU719/7X
MAHLE	OX188D
FRAM	CH9461
WEGA	WOE630
TECFIL	

**MEDIDAS (mm):**

COMPRIMENTO	
LARGURA	
ALTURA	141
D. INTERNO	29,4 / 23
D. EXTERNO	71,4
ROSCA	
BICOS	

**FOECO024**

**RENAULT**

**OEM:**  
7701206705

**EQUIVALÊNCIAS:**

MANN	HU611X
MAHLE	OX209DECO
FRAM	CH9580ECO
WEGA	WOE500
TECFIL	PEL705

**MEDIDAS (mm):**

COMPRIMENTO	
LARGURA	
ALTURA	87
D. INTERNO	25
D. EXTERNO	53
ROSCA	
BICOS	

**FOECO030**

**RENAULT**

**OEM:**  
7700109402  
7701472321

**EQUIVALÊNCIAS:**

MANN	HU923X
MAHLE	OX210D
FRAM	CH9462ECO
WEGA	WOE510
TECFIL	PEL312

**MEDIDAS (mm):**

COMPRIMENTO	
LARGURA	
ALTURA	93
D. INTERNO	33
D. EXTERNO	91
ROSCA	
BICOS	

**FOECO031**

**MB / SsangYOUNG**

**OEM:**  
51055040105  
6061800009

**EQUIVALÊNCIAS:**

MANN	HU951X
MAHLE	OX123/1D
FRAM	CH5640
WEGA	WEO0610
TECFIL	

**MEDIDAS (mm):**

COMPRIMENTO	
LARGURA	
ALTURA	174
D. INTERNO	33
D. EXTERNO	83
ROSCA	
BICOS	

**FOECO032**

**VOLVO**

**OEM:**  
8642570  
30757157

**EQUIVALÊNCIAS:**

MANN	HU719/8X
MAHLE	OX370D
FRAM	CH9496
WEGA	WOE810
TECFIL	

**MEDIDAS (mm):**

COMPRIMENTO	
LARGURA	
ALTURA	125
D. INTERNO	28
D. EXTERNO	65
ROSCA	
BICOS	

**FOECO033**

**VOLVO**

**OEM:**  
1275810  
1275811

**EQUIVALÊNCIAS:**

MANN	HU819X
MAHLE	OX149D
FRAM	CH8905
WEGA	WOE800
TECFIL	

**MEDIDAS (mm):**

COMPRIMENTO	
LARGURA	
ALTURA	79
D. INTERNO	23
D. EXTERNO	73
ROSCA	
BICOS	

**FOECO034**

**MB CAMINHÕES**

**OEM:**  
2931095  
4252248

**EQUIVALÊNCIAS:**

MANN	HU945/2X
MAHLE	OX174D
FRAM	CH9389
WEGA	WOE450
TECFIL	PEL2002

**MEDIDAS (mm):**

COMPRIMENTO	
LARGURA	
ALTURA	213
D. INTERNO	36/9
D. EXTERNO	83,4
ROSCA	
BICOS	

**FOECO035**

**LAND ROVER**

**OEM:**  
1457429118  
11422247392

**EQUIVALÊNCIAS:**

MANN	HU818X
MAHLE	OX156D
FRAM	CH9348
WEGA	WOE212
TECFIL	

**MEDIDAS (mm):**

COMPRIMENTO	
LARGURA	
ALTURA	78
D. INTERNO	24
D. EXTERNO	73
ROSCA	
BICOS	

**FOECO036**

**FORD**

**OEM:**  
1124160  
IS7J6744BA

**EQUIVALÊNCIAS:**

MANN	HU711X
MAHLE	OX203D
FRAM	CH10502
WEGA	WOE120
TECFIL	PEL106

**MEDIDAS (mm):**

COMPRIMENTO	
LARGURA	
ALTURA	74
D. INTERNO	28
D. EXTERNO	65
ROSCA	
BICOS	

**FOECO037**

**CITROËN / PEUGEOT**

**OEM:**  
1109R7  
9463704780

**EQUIVALÊNCIAS:**

MANN	HU612X
MAHLE	OX193D
FRAM	CH9443
WEGA	WOE700
TECFIL	PEL110

**MEDIDAS (mm):**

COMPRIMENTO	
LARGURA	
ALTURA	140
D. INTERNO	22
D. EXTERNO	59
ROSCA	
BICOS	



**FOECO040**

**MB**



<b>OEM:</b>	
1201800009	
1201840225	
<b>EQUIVALÊNCIAS:</b>	
MANN	HU736X
MAHLE	OX147D
FRAM	CH7338
WEGA	WOE303
TECFIL	
<b>MEDIDAS (mm):</b>	
COMPRIMENTO	
LARGURA	
ALTURA	216
D. INTERNO	19
D. EXTERNO	62
ROSCA	
BICOS	

**FOECO041**

**MB CAMINHÕES**



<b>OEM:</b>	
6131800009	
6131840025	
<b>EQUIVALÊNCIAS:</b>	
MANN	HU721/2X
MAHLE	OX179D
FRAM	CH9232ECO
WEGA	WOE242
TECFIL	PEL107
<b>MEDIDAS (mm):</b>	
COMPRIMENTO	
LARGURA	
ALTURA	137
D. INTERNO	31,5
D. EXTERNO	65
ROSCA	
BICOS	

**FOECO042**

**BMW**



<b>OEM:</b>	
11427506677	
11427511161	
<b>EQUIVALÊNCIAS:</b>	
MANN	HU715/5X
MAHLE	OX367D
FRAM	CH9955
WEGA	WOE214
TECFIL	
<b>MEDIDAS (mm):</b>	
COMPRIMENTO	
LARGURA	
ALTURA	104
D. INTERNO	34/9
D. EXTERNO	73
ROSCA	
BICOS	

**FOECO044**

**FIAT**



<b>OEM:</b>	
73500049	
1651185	
<b>EQUIVALÊNCIAS:</b>	
MANN	HU713/1X
MAHLE	OX371DECO
FRAM	CH9713
WEGA	WOE909
TECFIL	PEL118
<b>MEDIDAS (mm):</b>	
COMPRIMENTO	
LARGURA	
ALTURA	81
D. INTERNO	24
D. EXTERNO	65,5
ROSCA	
BICOS	

**FOECO048**

**JAGUAR / LAND ROVER**



<b>OEM:</b>	
1311289	
<b>EQUIVALÊNCIAS:</b>	
MANN	HU934/1X
MAHLE	OX205/2D
FRAM	CH10035ECO
WEGA	WOE243
TECFIL	
<b>MEDIDAS (mm):</b>	
COMPRIMENTO	
LARGURA	
ALTURA	151
D. INTERNO	25,5
D. EXTERNO	88,5
ROSCA	
BICOS	

**FOECO053**

**JEEP / MB**



<b>OEM:</b>	
05175571AA	
10517571AA	
<b>EQUIVALÊNCIAS:</b>	
MANN	HU821X
MAHLE	OX380DECO
FRAM	CH10323
WEGA	WOE304
TECFIL	
<b>MEDIDAS (mm):</b>	
COMPRIMENTO	
LARGURA	
ALTURA	94,5
D. INTERNO	31
D. EXTERNO	71
ROSCA	
BICOS	

**FOECO054**

**LEXUS**



<b>OEM:</b>	
04152YZZA1	
415231090	
<b>EQUIVALÊNCIAS:</b>	
MANN	HU7009Z
MAHLE	OX413D1
FRAM	CH9972
WEGA	
TECFIL	
<b>MEDIDAS (mm):</b>	
COMPRIMENTO	
LARGURA	
ALTURA	82
D. INTERNO	29
D. EXTERNO	70
ROSCA	
BICOS	

**FOECO056**

**HYUNDAI**



<b>OEM:</b>	
2632027400	
2632027401	
<b>EQUIVALÊNCIAS:</b>	
MANN	HU822/5X
MAHLE	OX436D
FRAM	CH10473ECO
WEGA	
TECFIL	
<b>MEDIDAS (mm):</b>	
COMPRIMENTO	
LARGURA	
ALTURA	110
D. INTERNO	33
D. EXTERNO	72
ROSCA	
BICOS	

**FOECO060**

**CITROËN / FORD / MINI / PEUGEOT**



<b>OEM:</b>	
13034761109X4	
30650798	
<b>EQUIVALÊNCIAS:</b>	
MANN	HU711/51X
MAHLE	OX339/2D
FRAM	CH9973
WEGA	WOE710
TECFIL	PEL108
<b>MEDIDAS (mm):</b>	
COMPRIMENTO	
LARGURA	
ALTURA	70
D. INTERNO	24
D. EXTERNO	67
ROSCA	
BICOS	

**FOECO061**

**MB**



<b>OEM:</b>	
2711800109	
2711800009	
<b>EQUIVALÊNCIAS:</b>	
MANN	HU514X
MAHLE	OX183/1D
FRAM	CH9918
WEGA	WOE460
TECFIL	PEL719
<b>MEDIDAS (mm):</b>	
COMPRIMENTO	
LARGURA	
ALTURA	155
D. INTERNO	20
D. EXTERNO	47
ROSCA	
BICOS	

**BMW**

**FOECO062**

OEM:  
11427541827  
11427566327

EQUIVALÊNCIAS:

MANN	HU816X
MAHLE	OX387D
FRAM	CH10075ECO
WEGA	WOE221
TECFIL	

MEDIDAS (mm):

COMPRIMENTO	
LARGURA	
ALTURA	80
D. INTERNO	36
D. EXTERNO	73
ROSCA	
BICOS	

**AUDI / VW**

**FOECO063**

OEM:  
06D115562  
06D115466

EQUIVALÊNCIAS:

MANN	HU719/6X
MAHLE	OX379D
FRAM	CH9911
WEGA	WOE640
TECFIL	PEL313

MEDIDAS (mm):

COMPRIMENTO	
LARGURA	
ALTURA	124
D. INTERNO	28
D. EXTERNO	65
ROSCA	
BICOS	

**FORD / MB / TROLLER**

**FOECO064**

OEM:  
6281800009  
71180

EQUIVALÊNCIAS:

MANN	HU934X
MAHLE	OX169/1D
FRAM	CH9801ECO
WEGA	WOE130
TECFIL	PEL310

MEDIDAS (mm):

COMPRIMENTO	
LARGURA	
ALTURA	150
D. INTERNO	34
D. EXTERNO	83
ROSCA	
BICOS	

**RENAULT**

**FOECO068**

OEM:  
1520900Q0A  
8200362442

EQUIVALÊNCIAS:

MANN	HU618X
MAHLE	OX441D
FRAM	CH11208ECO
WEGA	WOE505
TECFIL	

MEDIDAS (mm):

COMPRIMENTO	
LARGURA	
ALTURA	113
D. INTERNO	24
D. EXTERNO	58
ROSCA	
BICOS	

**AUDI / LAND ROVER**

**FOECO069**

OEM:  
LR002338  
70308198

EQUIVALÊNCIAS:

MANN	HU8003X
MAHLE	OX196/1D1
FRAM	
WEGA	WOE246
TECFIL	

MEDIDAS (mm):

COMPRIMENTO	
LARGURA	
ALTURA	196
D. INTERNO	28/29
D. EXTERNO	75
ROSCA	
BICOS	

**CADILLAC / CHEVROLET / PONTIAC**

**FOECO070**

OEM:  
25177917  
71741042

EQUIVALÊNCIAS:

MANN	ML1044
MAHLE	OX399D
FRAM	CH8765
WEGA	WEO0309
TECFIL	

MEDIDAS (mm):

COMPRIMENTO	
LARGURA	
ALTURA	96
D. INTERNO	18
D. EXTERNO	53
ROSCA	
BICOS	

**TOYOTA**

**FOECO071**

OEM:  
0415238020  
04152-YZZA4

EQUIVALÊNCIAS:

MANN	OX 554D2
MAHLE	CH10295ECO
FRAM	
WEGA	
TECFIL	

MEDIDAS (mm):

COMPRIMENTO	
LARGURA	
ALTURA	117
D. INTERNO	28
D. EXTERNO	70
ROSCA	
BICOS	

**CHEVROLET**

**FOECO073**

OEM:  
93185674  
55353324

EQUIVALÊNCIAS:

MANN	HU612/2X
MAHLE	OX401D
FRAM	CH10246
WEGA	WOE313
TECFIL	PEL674

MEDIDAS (mm):

COMPRIMENTO	
LARGURA	
ALTURA	106
D. INTERNO	23/9
D. EXTERNO	57
ROSCA	
BICOS	

**MB**

**FOECO074**

OEM:  
2661800009  
2661840325

EQUIVALÊNCIAS:

MANN	HU612/1X
MAHLE	OX382D
FRAM	CH10054
WEGA	WOE308
TECFIL	

MEDIDAS (mm):

COMPRIMENTO	
LARGURA	
ALTURA	81
D. INTERNO	27/10
D. EXTERNO	57
ROSCA	
BICOS	

**HYUNDAI / KIA**

**FOECO075**

OEM:  
263203C100

EQUIVALÊNCIAS:

MANN	HU824X
MAHLE	OX773D
FRAM	
WEGA	WOE903
TECFIL	

MEDIDAS (mm):

COMPRIMENTO	
LARGURA	
ALTURA	132
D. INTERNO	40
D. EXTERNO	73
ROSCA	
BICOS	



**HYUNDAI / KIA**

### FOECO076

<b>OEM:</b>	
263303C300 263202A500	
<b>EQUIVALÊNCIAS:</b>	
MANN	HU7001X
MAHLE	OX351D
FRAM	CH10670ECO
WEGA	WOE904
TECFIL	
<b>MEDIDAS (mm):</b>	
COMPRIMENTO	
LARGURA	
ALTURA	104
D. INTERNO	20
D. EXTERNO	65
ROSCA	
BICOS	

**LEXUS / TOYOTA**

### FOECO078

<b>OEM:</b>	
415237010	
<b>EQUIVALÊNCIAS:</b>	
MANN	
MAHLE	OX416D
FRAM	
WEGA	WOE803
TECFIL	
<b>MEDIDAS (mm):</b>	
COMPRIMENTO	
LARGURA	
ALTURA	56
D. INTERNO	28
D. EXTERNO	60
ROSCA	
BICOS	

**BMW**

### FOECO079

<b>OEM:</b>	
11427501676	
<b>EQUIVALÊNCIAS:</b>	
MANN	HU815/2X
MAHLE	OX166/1D
FRAM	
WEGA	WOE211
TECFIL	
<b>MEDIDAS (mm):</b>	
COMPRIMENTO	
LARGURA	
ALTURA	80
D. INTERNO	32
D. EXTERNO	72
ROSCA	
BICOS	

**BMW**

### FOECO080

<b>OEM:</b>	
11421709856 11421727300	
<b>EQUIVALÊNCIAS:</b>	
MANN	HU921X
MAHLE	OX91D
FRAM	CH5151
WEGA	WEO0523
TECFIL	
<b>MEDIDAS (mm):</b>	
COMPRIMENTO	
LARGURA	
ALTURA	87,5
D. INTERNO	28
D. EXTERNO	82
ROSCA	
BICOS	

**BMW**

### FOECO081

<b>OEM:</b>	
11427521008 11427542021	
<b>EQUIVALÊNCIAS:</b>	
MANN	HU823X
MAHLE	OX636D
FRAM	
WEGA	WOE241
TECFIL	
<b>MEDIDAS (mm):</b>	
COMPRIMENTO	
LARGURA	
ALTURA	103
D. INTERNO	32/14
D. EXTERNO	76,5
ROSCA	
BICOS	

**BMW**

### FOECO082

<b>OEM:</b>	
11427834734 11427840594	
<b>EQUIVALÊNCIAS:</b>	
MANN	HU926/5X
MAHLE	OX254D2
FRAM	CH11038
WEGA	WOE402
TECFIL	
<b>MEDIDAS (mm):</b>	
COMPRIMENTO	
LARGURA	
ALTURA	108
D. INTERNO	30
D. EXTERNO	82
ROSCA	
BICOS	

**BMW**

### FOECO083

<b>OEM:</b>	
11427833242 11427833769	
<b>EQUIVALÊNCIAS:</b>	
MANN	HU926/4X
MAHLE	OX187D
FRAM	CH5320
WEGA	WEO0522
TECFIL	
<b>MEDIDAS (mm):</b>	
COMPRIMENTO	
LARGURA	
ALTURA	108,5
D. INTERNO	28
D. EXTERNO	82
ROSCA	
BICOS	

**MB CAMINHÕES**

### FOECO084

<b>OEM:</b>	
0001802109 0001802909	
<b>EQUIVALÊNCIAS:</b>	
MANN	HU12110X
MAHLE	OX348D
FRAM	CH9558
WEGA	WOE451
TECFIL	PEL2004
<b>MEDIDAS (mm):</b>	
COMPRIMENTO	
LARGURA	
ALTURA	265
D. INTERNO	54/14
D. EXTERNO	120,8
ROSCA	
BICOS	

**AUDI**

### FOECO085

<b>OEM:</b>	
079115561B 079198405A	
<b>EQUIVALÊNCIAS:</b>	
MANN	HU835/1Z
MAHLE	OX358D
FRAM	
WEGA	WOE650
TECFIL	
<b>MEDIDAS (mm):</b>	
COMPRIMENTO	
LARGURA	
ALTURA	144
D. INTERNO	36/9
D. EXTERNO	73
ROSCA	
BICOS	

**VW**

### FOECO086

<b>OEM:</b>	
077115561H 077115562	
<b>EQUIVALÊNCIAS:</b>	
MANN	HU932/7X
MAHLE	OX356D
FRAM	
WEGA	WOE670
TECFIL	
<b>MEDIDAS (mm):</b>	
COMPRIMENTO	
LARGURA	
ALTURA	112
D. INTERNO	37/21
D. EXTERNO	83
ROSCA	
BICOS	

**FOECO087**

**AUDI / VW**



<b>OEM:</b>	
079115561F 079198405B	
<b>EQUIVALÊNCIAS:</b>	
MANN	HU7005X
MAHLE	OX350D
FRAM	
WEGA	W0E660
TECFIL	
<b>MEDIDAS (mm):</b>	
COMPRIMENTO	
LARGURA	
ALTURA	128
D. INTERNO	26/20
D. EXTERNO	68
ROSCA	
BICOS	

**FOECO088**

**MB**



<b>OEM:</b>	
2751800009 2751840025	
<b>EQUIVALÊNCIAS:</b>	
MANN	HU721/3X
MAHLE	OX383D
FRAM	
WEGA	W0E306
TECFIL	
<b>MEDIDAS (mm):</b>	
COMPRIMENTO	
LARGURA	
ALTURA	135
D. INTERNO	31
D. EXTERNO	64
ROSCA	
BICOS	

**FOECO089**

**AUDI**



<b>OEM:</b>	
077115561F 077198563	
<b>EQUIVALÊNCIAS:</b>	
MANN	H1032/1X
MAHLE	OX122D
FRAM	
WEGA	WEO0620
TECFIL	
<b>MEDIDAS (mm):</b>	
COMPRIMENTO	
LARGURA	
ALTURA	85
D. INTERNO	24,5
D. EXTERNO	94,6
ROSCA	
BICOS	

**FOECO090**

**BMW**



<b>OEM:</b>	
11421729628 11421731634	
<b>EQUIVALÊNCIAS:</b>	
MANN	H943/7X
MAHLE	OX103D
FRAM	CH8157
WEGA	WEO0517/1
TECFIL	
<b>MEDIDAS (mm):</b>	
COMPRIMENTO	
LARGURA	
ALTURA	160,5
D. INTERNO	38/24,5
D. EXTERNO	83
ROSCA	
BICOS	

**FOECO091**

**BMW**



<b>OEM:</b>	
11421267268 11421269373	
<b>EQUIVALÊNCIAS:</b>	
MANN	HU930/3X
MAHLE	OX41D
FRAM	CH2965
WEGA	WEO0517
TECFIL	
<b>MEDIDAS (mm):</b>	
COMPRIMENTO	
LARGURA	
ALTURA	127
D. INTERNO	28
D. EXTERNO	82
ROSCA	
BICOS	

**FOECO093**

**HYUNDAI / KIA**



<b>OEM:</b>	
263203C250	
<b>EQUIVALÊNCIAS:</b>	
MANN	
MAHLE	
FRAM	CH10515
WEGA	W0E905
TECFIL	
<b>MEDIDAS (mm):</b>	
COMPRIMENTO	
LARGURA	
ALTURA	106
D. INTERNO	65
D. EXTERNO	26
ROSCA	
BICOS	

**FOECO094**

**TOYOTA**



<b>OEM:</b>	
0415251010	
<b>EQUIVALÊNCIAS:</b>	
MANN	
MAHLE	OX554D1
FRAM	CH10295
WEGA	
TECFIL	
<b>MEDIDAS (mm):</b>	
COMPRIMENTO	
LARGURA	
ALTURA	117
D. INTERNO	28
D. EXTERNO	70
ROSCA	
BICOS	

**FOECO096**

**HYUNDAI / KIA**



<b>OEM:</b>	
263202F000 263202F010	
<b>EQUIVALÊNCIAS:</b>	
MANN	
MAHLE	OX377D
FRAM	
WEGA	
TECFIL	
<b>MEDIDAS (mm):</b>	
COMPRIMENTO	
LARGURA	
ALTURA	130
D. INTERNO	20
D. EXTERNO	65
ROSCA	
BICOS	

**FOECO098**

**VW**



<b>OEM:</b>	
03L115466 03L115562	
<b>EQUIVALÊNCIAS:</b>	
MANN	HU7008Z
MAHLE	OX388D
FRAM	CH10759ECO
WEGA	W0E680
TECFIL	
<b>MEDIDAS (mm):</b>	
COMPRIMENTO	
LARGURA	
ALTURA	101
D. INTERNO	21
D. EXTERNO	65
ROSCA	
BICOS	

**FOECO099**

**LAND ROVER**



<b>OEM:</b>	
9X2Q6744AA LR013148	
<b>EQUIVALÊNCIAS:</b>	
MANN	HU826X
MAHLE	OX776D
FRAM	CH11015
WEGA	W0E245
TECFIL	
<b>MEDIDAS (mm):</b>	
COMPRIMENTO	
LARGURA	
ALTURA	95
D. INTERNO	38
D. EXTERNO	78
ROSCA	
BICOS	



SSANGYONG	<b>FOECO105</b>	OEM: 6711803009
	EQUIVALÊNCIAS:	
	MANN	
	MAHLE	
	FRAM	
WEGA		
TECFIL		
MEDIDAS (mm):		
COMPRIMENTO		
LARGURA		
ALTURA	125	
D. INTERNO	25	
D. EXTERNO	62	
ROSCA		
BICOS		



AUDI	<b>FOECO108</b>	OEM: 06E115466 06E115562
	EQUIVALÊNCIAS:	
	MANN	HU722Z
	MAHLE	OX381D
	FRAM	CH10160ECO
WEGA	WOE612	
TECFIL		
MEDIDAS (mm):		
COMPRIMENTO		
LARGURA		
ALTURA	155	
D. INTERNO	31	
D. EXTERNO	64	
ROSCA		
BICOS		



BMW	<b>FOECO112</b>	OEM: 11427837997
	EQUIVALÊNCIAS:	
	MANN	HU926/5Z
	MAHLE	OX254D3
	FRAM	
WEGA	WOE403	
TECFIL		
MEDIDAS (mm):		
COMPRIMENTO		
LARGURA		
ALTURA	108	
D. INTERNO	32	
D. EXTERNO	83	
ROSCA		
BICOS		



MB	<b>FOECO115</b>	OEM: 6291800109
	EQUIVALÊNCIAS:	
	MANN	HU926/5Y
	MAHLE	OX254D1
	FRAM	
WEGA		
TECFIL		
MEDIDAS (mm):		
COMPRIMENTO		
LARGURA		
ALTURA	108	
D. INTERNO	34	
D. EXTERNO	83	
ROSCA		
BICOS		



RENAULT	<b>FOECO119</b>	OEM: 15209-00Q0D 93168068
	EQUIVALÊNCIAS:	
	MANN	
	MAHLE	OX389/1D
	FRAM	
WEGA		
TECFIL		
MEDIDAS (mm):		
COMPRIMENTO		
LARGURA		
ALTURA	112	
D. INTERNO	18	
D. EXTERNO	57	
ROSCA		
BICOS		



KIA	<b>FOECO121</b>	OEM: 263203A000 263203A001
	EQUIVALÊNCIAS:	
	MANN	
	MAHLE	OX775D
	FRAM	
WEGA	WOE910	
TECFIL		
MEDIDAS (mm):		
COMPRIMENTO		
LARGURA		
ALTURA	183,5	
D. INTERNO	32	
D. EXTERNO	66	
ROSCA		
BICOS		



JEEP	<b>FOECO122</b>	OEM: 68109834AA
	EQUIVALÊNCIAS:	
	MANN	
	MAHLE	
	FRAM	
WEGA		
TECFIL		
MEDIDAS (mm):		
COMPRIMENTO		
LARGURA		
ALTURA	124	
D. INTERNO	25	
D. EXTERNO	66	
ROSCA		
BICOS		



PLURIFILTER	<b>P1</b>	OEM:
	EQUIVALÊNCIAS:	
	MANN	W7MULTI18
	MAHLE	OC504
	FRAM	PH10905MIX19
WEGA	WUNIO003	
TECFIL	TM3	
MEDIDAS (mm):		
COMPRIMENTO		
LARGURA		
ALTURA	88,4	
D. INTERNO	62	
D. EXTERNO	76	
ROSCA	M18x1,5	
BICOS		



PLURIFILTER	<b>P2</b>	OEM:
	EQUIVALÊNCIAS:	
	MANN	W7MULTI20
	MAHLE	OC505
	FRAM	PH10906MIX20
WEGA	WUNIO004	
TECFIL	TM4	
MEDIDAS (mm):		
COMPRIMENTO		
LARGURA		
ALTURA	88,4	
D. INTERNO	62	
D. EXTERNO	76	
ROSCA	M20x1,5	
BICOS		



PLURIFILTER	<b>P3</b>	OEM:
	EQUIVALÊNCIAS:	
	MANN	W7MULTI3/4S
	MAHLE	OC506
	FRAM	PH10907MIX3/4
WEGA	WUNIO001	
TECFIL	TM1	
MEDIDAS (mm):		
COMPRIMENTO		
LARGURA		
ALTURA	88,4	
D. INTERNO	62	
D. EXTERNO	76	
ROSCA	3/4"	
BICOS		



**P4**

PLURIFILTER



OEM:	
EQUIVALÊNCIAS:	
MANN	W7MULTI3/4D
MAHLE	OC522
FRAM	PH10908MIX3/4-2
WEGA	WUN10002
TECFIL	TM2
MEDIDAS (mm):	
COMPRIMENTO	
LARGURA	
ALTURA	102
D. INTERNO	62
D. EXTERNO	76
ROSCA	3/4"
BICOS	

**P5**

PLURIFILTER



OEM:	
EQUIVALÊNCIAS:	
MANN	W6MULTI20
MAHLE	OC600
FRAM	PH10904MIX20-2
WEGA	WUN10005
TECFIL	TM5
MEDIDAS (mm):	
COMPRIMENTO	
LARGURA	
ALTURA	86,5
D. INTERNO	54,5
D. EXTERNO	65,1
ROSCA	M20x1,5
BICOS	

**FC002S**

CHEVROLET / GMC / HUMMER



OEM:	
88983068	
15015509	
EQUIVALÊNCIAS:	
MANN	
MAHLE	
FRAM	G9344
WEGA	FCI1120
TECFIL	
MEDIDAS (mm):	
COMPRIMENTO	119
D. INTERNO	
D. EXTERNO	55
ROSCA IN	
ROSCA OUT	
BICOS IN	IN:9,5
BICOS OUT	OUT:9,5

**FC012S**

JEEP / MB



OEM:	
05117492AA	
05175425AB	
EQUIVALÊNCIAS:	
MANN	WK842/23X
MAHLE	KL228/2D
FRAM	P10148
WEGA	FCD2163
TECFIL	
MEDIDAS (mm):	
COMPRIMENTO	125
D. INTERNO	
D. EXTERNO	91
ROSCA IN	
ROSCA OUT	
BICOS IN	IN:10
BICOS OUT	OUT:8

**FC016S**

CADILLAC



OEM:	
25763176	
EQUIVALÊNCIAS:	
MANN	
MAHLE	KL847
FRAM	G11296
WEGA	
TECFIL	
MEDIDAS (mm):	
COMPRIMENTO	156
D. INTERNO	
D. EXTERNO	55
ROSCA IN	M16X1,5
ROSCA OUT	
BICOS IN	IN:8
BICOS OUT	OUT:9,5

**FC018S**

CHERY



OEM:	
T111117110	
EQUIVALÊNCIAS:	
MANN	
MAHLE	
FRAM	
WEGA	JFCF02
TECFIL	
MEDIDAS (mm):	
COMPRIMENTO	143
D. INTERNO	
D. EXTERNO	56
ROSCA IN	
ROSCA OUT	
BICOS IN	IN:8
BICOS OUT	OUT:8

**FC020S**

CHERY



OEM:	
B141117110	
702060143	
EQUIVALÊNCIAS:	
MANN	
MAHLE	
FRAM	JFCF00
WEGA	G106/7
TECFIL	
MEDIDAS (mm):	
COMPRIMENTO	172
D. INTERNO	
D. EXTERNO	77
ROSCA IN	
ROSCA OUT	
BICOS IN	IN:8
BICOS OUT	OUT:8

**FC100S**

NISSAN



OEM:	
16400EC00A	
EQUIVALÊNCIAS:	
MANN	WK920/6
MAHLE	KL440/6
FRAM	P10533
WEGA	JFC199
TECFIL	
MEDIDAS (mm):	
COMPRIMENTO	139
D. INTERNO	
D. EXTERNO	93
ROSCA IN	
ROSCA OUT	
BICOS IN	IN:10
BICOS OUT	OUT:10

**FC102S**

NISSAN



OEM:	
8942075330	
8942394930	
EQUIVALÊNCIAS:	
MANN	WK79/80
MAHLE	KL186
FRAM	G4194
WEGA	JFC102
TECFIL	
MEDIDAS (mm):	
COMPRIMENTO	118,5
D. INTERNO	
D. EXTERNO	78
ROSCA IN	
ROSCA OUT	
BICOS IN	IN:8
BICOS OUT	OUT:8

**FC109S**

NISSAN



OEM:	
16400V7200	
1640359	
EQUIVALÊNCIAS:	
MANN	WK940/6
MAHLE	KC67
FRAM	P5138
WEGA	JFC109
TECFIL	
MEDIDAS (mm):	
COMPRIMENTO	144
D. INTERNO	73
D. EXTERNO	99
ROSCA IN	IN:3/4"X16
ROSCA OUT	OUT:34,5
BICOS IN	
BICOS OUT	



**FC111S**

NISSAN



<b>OEM:</b>	
164000W010	
1640041B00	
<b>EQUIVALÊNCIAS:</b>	
MANN	WK66
MAHLE	KL171
FRAM	G4777
WEGA	JFC111
<b>MEDIDAS (mm):</b>	
COMPRIMENTO	118
D. INTERNO	
D. EXTERNO	61
ROSCA IN	
ROSCA OUT	
BICOS IN	IN:8
BICOS OUT	OUT:8

**FC119S**

NISSAN



<b>OEM:</b>	
1640502N10	
<b>EQUIVALÊNCIAS:</b>	
MANN	WK932/80
MAHLE	
FRAM	P5163
WEGA	JFC119
<b>MEDIDAS (mm):</b>	
COMPRIMENTO	125
D. INTERNO	73
D. EXTERNO	97
ROSCA IN	3/4"x16
ROSCA OUT	
BICOS IN	
BICOS OUT	

**FC124S**

NISSAN



<b>OEM:</b>	
164002Y501	
164002Y505	
<b>EQUIVALÊNCIAS:</b>	
MANN	
MAHLE	
FRAM	
WEGA	JFC150
TECFIL	
<b>MEDIDAS (mm):</b>	
COMPRIMENTO	133
D. INTERNO	
D. EXTERNO	86
ROSCA IN	
ROSCA OUT	
BICOS IN	IN:18
BICOS OUT	OUT:18

**FC128S**

NISSAN



<b>OEM:</b>	
16400EC00B	
16400JD50C	
<b>EQUIVALÊNCIAS:</b>	
MANN	WK9011
MAHLE	KL440/4
FRAM	P11235
WEGA	JFC199/1
TECFIL	
<b>MEDIDAS (mm):</b>	
COMPRIMENTO	123
D. INTERNO	93
D. EXTERNO	
ROSCA IN	
ROSCA OUT	
BICOS IN	IN:10
BICOS OUT	OUT:10

**FC190S**

NISSAN



<b>OEM:</b>	
164037F400	
164037F401	
<b>EQUIVALÊNCIAS:</b>	
MANN	WK940/22
MAHLE	KC189
FRAM	PS9638
WEGA	FCD2066/3
TECFIL	
<b>MEDIDAS (mm):</b>	
COMPRIMENTO	153
D. INTERNO	72
D. EXTERNO	97
ROSCA IN	3/4"x16
ROSCA OUT	
BICOS IN	
BICOS OUT	

**FC192S**

FIAT



<b>OEM:</b>	
7711130026	
7700974993	
<b>EQUIVALÊNCIAS:</b>	
MANN	WK830
MAHLE	KL2
FRAM	G3829
WEGA	
TECFIL	GI01/1
<b>MEDIDAS (mm):</b>	
COMPRIMENTO	162,6
D. INTERNO	
D. EXTERNO	80
ROSCA IN	
ROSCA OUT	
BICOS IN	IN:8
BICOS OUT	OUT:8

**FC197S**

NISSAN



<b>OEM:</b>	
1640501T70	
1640306J60	
<b>EQUIVALÊNCIAS:</b>	
MANN	WK850/1
MAHLE	KC239
FRAM	P5162
WEGA	JFC197
TECFIL	
<b>MEDIDAS (mm):</b>	
COMPRIMENTO	180
D. INTERNO	62
D. EXTERNO	83
ROSCA IN	34,5
ROSCA OUT	
BICOS IN	
BICOS OUT	

**FC198S**

INFINITY / NISSAN



<b>OEM:</b>	
1640053J10	
1640072L00	
<b>EQUIVALÊNCIAS:</b>	
MANN	WK56
MAHLE	KL202
FRAM	
WEGA	JFC694
TECFIL	
<b>MEDIDAS (mm):</b>	
COMPRIMENTO	120
D. INTERNO	
D. EXTERNO	64
ROSCA IN	
ROSCA OUT	
BICOS IN	IN:8
BICOS OUT	OUT:8

**FC200S**

NISSAN



<b>OEM:</b>	
233900L010	
2339030200	
<b>EQUIVALÊNCIAS:</b>	
MANN	PU835X
MAHLE	KX268D
FRAM	C10353ECO
WEGA	JFC207/2
TECFIL	PC949
<b>MEDIDAS (mm):</b>	
COMPRIMENTO	76
D. INTERNO	9
D. EXTERNO	84
ROSCA IN	
ROSCA OUT	
BICOS IN	
BICOS OUT	

**FC212/3S**

DODGE



<b>OEM:</b>	
5015581AA	
5015581AC	
<b>EQUIVALÊNCIAS:</b>	
MANN	P938
MAHLE	
FRAM	CS8941
WEGA	FCD0651
TECFIL	FC164
<b>MEDIDAS (mm):</b>	
COMPRIMENTO	103
D. INTERNO	20
D. EXTERNO	86
ROSCA IN	
ROSCA OUT	
BICOS IN	
BICOS OUT	

**FC215S**

MAZDA / TOYOTA



OEM:  
2330364010  
1770A053

EQUIVALÊNCIAS:

MANN	WK828
MAHLE	KC83
FRAM	P4922
WEGA	JFC215
TECFIL	PSC999

MEDIDAS (mm):

COMPRIMENTO	140
D. INTERNO	64
D. EXTERNO	93,6
ROSCA IN	IN:3/4"x16
ROSCA OUT	OUT:34,5
BICOS IN	
BICOS OUT	

**FC215MP**

MAZDA / TOYOTA



OEM:  
2330364010  
1770A053

EQUIVALÊNCIAS:

MANN	WK828
MAHLE	KC83
FRAM	P4922
WEGA	
TECFIL	PSC999

MEDIDAS (mm):

COMPRIMENTO	140
D. INTERNO	64
D. EXTERNO	93,6
ROSCA IN	IN:3/4"x16
ROSCA OUT	OUT:34,5
BICOS IN	
BICOS OUT	

**FC216S**

SUZUKI



OEM:  
1541061A00  
2330043020

EQUIVALÊNCIAS:

MANN	WK614/8
MAHLE	KL203
FRAM	G7196
WEGA	JFC811
TECFIL	

MEDIDAS (mm):

COMPRIMENTO	131
D. INTERNO	
D. EXTERNO	70
ROSCA IN	IN:12x1,25
ROSCA OUT	OUT:12x1,25
BICOS IN	
BICOS OUT	

**FC234S**

TOYOTA



OEM:  
2330021010

EQUIVALÊNCIAS:

MANN	
MAHLE	
FRAM	
WEGA	JFC235/1
TECFIL	

MEDIDAS (mm):

COMPRIMENTO	136
D. INTERNO	
D. EXTERNO	95
ROSCA IN	
ROSCA OUT	
BICOS IN	IN:13
BICOS OUT	OUT:14,5

**FC235S**

TOYOTA



OEM:  
2330019295

EQUIVALÊNCIAS:

MANN	WK614/36X
MAHLE	KL140
FRAM	G7612
WEGA	JFC235
TECFIL	

MEDIDAS (mm):

COMPRIMENTO	123
D. INTERNO	
D. EXTERNO	71
ROSCA IN	IN:14x1,5
ROSCA OUT	OUT:M12x1,25
BICOS IN	
BICOS OUT	

**FC240S**

TOYOTA



OEM:  
2339064480

EQUIVALÊNCIAS:

MANN	
MAHLE	KC135
FRAM	
WEGA	JFC240
TECFIL	PSC999

MEDIDAS (mm):

COMPRIMENTO	134
D. INTERNO	66
D. EXTERNO	95
ROSCA IN	IN:3/4"x16
ROSCA OUT	OUT:34
BICOS IN	
BICOS OUT	

**FC244S**

TOYOTA



OEM:  
2330022040  
2330022050

EQUIVALÊNCIAS:

MANN	WK614/24X
MAHLE	KL246
FRAM	G9995
WEGA	
TECFIL	

MEDIDAS (mm):

COMPRIMENTO	153
D. INTERNO	
D. EXTERNO	65,6
ROSCA IN	IN:M14x1,5
ROSCA OUT	OUT:8
BICOS IN	
BICOS OUT	

**FC247S**

HYUNDAI / LEXUS / TOYOTA



OEM:  
2330050020  
2330053020

EQUIVALÊNCIAS:

MANN	WK614/11
MAHLE	KL522
FRAM	G6680
WEGA	JFC247
TECFIL	

MEDIDAS (mm):

COMPRIMENTO	113,3
D. INTERNO	
D. EXTERNO	70,3
ROSCA IN	IN:M14x1,5
ROSCA OUT	OUT:M14x1,5
BICOS IN	
BICOS OUT	

**FC248S**

TOYOTA



OEM:  
2330356040

EQUIVALÊNCIAS:

MANN	WK828
MAHLE	KC83
FRAM	P4922
WEGA	JFC248
TECFIL	PSC999

MEDIDAS (mm):

COMPRIMENTO	173
D. INTERNO	64
D. EXTERNO	93,5
ROSCA IN	IN:3/4"x16
ROSCA OUT	OUT:34,4
BICOS IN	
BICOS OUT	

**FC255S**

TOYOTA



OEM:  
2330028040  
2330028030

EQUIVALÊNCIAS:

MANN	
MAHLE	
FRAM	
WEGA	JFC285
TECFIL	

MEDIDAS (mm):

COMPRIMENTO	141
D. INTERNO	
D. EXTERNO	94
ROSCA IN	
ROSCA OUT	
BICOS IN	IN:13
BICOS OUT	OUT:15



TOYOTA	<b>FC284S</b>	OEM: 2330023040 2330028030
	EQUIVALÊNCIAS:	
	MANN	
	MAHLE	
	FRAM	
WEGA	JFC284	
TECFIL		
MEDIDAS (mm):		
COMPRIMENTO	137	
D. INTERNO		
D. EXTERNO	97	
ROSCA IN		
ROSCA OUT		
BICOS IN	IN:15	
BICOS OUT	OUT:15,5	



TOYOTA	<b>FC288S</b>	OEM: 2330016330 2330074310
	EQUIVALÊNCIAS:	
	MANN	WK68/82
	MAHLE	KL513
	FRAM	G9809
WEGA		
TECFIL		
MEDIDAS (mm):		
COMPRIMENTO	125	
D. INTERNO		
D. EXTERNO	65,5	
ROSCA IN		
ROSCA OUT		
BICOS IN	IN:14x1,5	
BICOS OUT	OUT:8	



MITSUBISHI / TOYOTA	<b>FC292S</b>	OEM: 2330049195 2330079455
	EQUIVALÊNCIAS:	
	MANN	WK614/24X
	MAHLE	KL435
	FRAM	G7770
WEGA	JFC227	
TECFIL		
MEDIDAS (mm):		
COMPRIMENTO	99	
D. INTERNO		
D. EXTERNO	64	
ROSCA IN	IN:M14x1,5	
ROSCA OUT	OUT:M12x1,25	
BICOS IN		
BICOS OUT		



MITSUBISHI / TOYOTA	<b>FC298S</b>	OEM: 2330079285 2330076080
	EQUIVALÊNCIAS:	
	MANN	WK614/25
	MAHLE	
	FRAM	G7072
WEGA	JFC298	
TECFIL		
MEDIDAS (mm):		
COMPRIMENTO	132,3	
D. INTERNO		
D. EXTERNO	72	
ROSCA IN	IN:M12x1,25	
ROSCA OUT	OUT:M12x1,25	
BICOS IN		
BICOS OUT		



KIA / MAZDA	<b>FC303S</b>	OEM: PN4713ZA5 RF0313850A
	EQUIVALÊNCIAS:	
	MANN	WK920/3
	MAHLE	KC59
	FRAM	P3726
WEGA	JFC303	
TECFIL	PSC998	
MEDIDAS (mm):		
COMPRIMENTO	123	
D. INTERNO	73	
D. EXTERNO	98,5	
ROSCA IN	M20x1,5	
ROSCA OUT		
BICOS IN		
BICOS OUT		



KIA / MAZDA	<b>FC313S</b>	OEM: 0K55W20490 0K55820490
	EQUIVALÊNCIAS:	
	MANN	WK614/48
	MAHLE	
	FRAM	
WEGA	JFC313 / JFCK10	
TECFIL		
MEDIDAS (mm):		
COMPRIMENTO	136	
D. INTERNO		
D. EXTERNO	71	
ROSCA IN		
ROSCA OUT		
BICOS IN	IN:8	
BICOS OUT	OUT:8	



KIA / MAZDA	<b>FC315S</b>	OEM: BP0120490A B6BF13480
	EQUIVALÊNCIAS:	
	MANN	WK614/9
	MAHLE	KL115
	FRAM	G7146
WEGA	JFC315	
TECFIL		
MEDIDAS (mm):		
COMPRIMENTO	170	
D. INTERNO		
D. EXTERNO	71	
ROSCA IN		
ROSCA OUT		
BICOS IN	IN:8	
BICOS OUT	OUT:8	



MAZDA	<b>FC316S</b>	OEM: B61P20490 25175549
	EQUIVALÊNCIAS:	
	MANN	WK614/45
	MAHLE	KL517
	FRAM	G8615
WEGA	JFC316	
TECFIL		
MEDIDAS (mm):		
COMPRIMENTO	150	
D. INTERNO		
D. EXTERNO	71	
ROSCA IN		
ROSCA OUT		
BICOS IN	IN:8,5	
BICOS OUT	OUT:8,5	



MAZDA	<b>FC390S</b>	OEM: N3A120490 MF5567
	EQUIVALÊNCIAS:	
	MANN	
	MAHLE	
	FRAM	G7392
WEGA		
TECFIL		
MEDIDAS (mm):		
COMPRIMENTO	134	
D. INTERNO		
D. EXTERNO	71	
ROSCA IN		
ROSCA OUT		
BICOS IN	IN:8	
BICOS OUT	OUT:8	



MAZDA	<b>FC391S</b>	OEM: JE1520490A JE1513480
	EQUIVALÊNCIAS:	
	MANN	
	MAHLE	KL444
	FRAM	G7296
WEGA	JFC391	
TECFIL		
MEDIDAS (mm):		
COMPRIMENTO	146	
D. INTERNO		
D. EXTERNO	72	
ROSCA IN		
ROSCA OUT		
BICOS IN	IN:8	
BICOS OUT	OUT:8	



**FC393S**



CHEVROLET / DAEWOO / GMC / JAGUAR

<b>OEM:</b>	
25055129	
25055046	
<b>EQUIVALÊNCIAS:</b>	
MANN	WK612/2
MAHLE	KL158
FRAM	G3727
WEGA	FC11117
TECFIL	GI13
<b>MEDIDAS (mm):</b>	
COMPRIMENTO	111
D. INTERNO	
D. EXTERNO	60
ROSCA IN	IN:M16x1,5
ROSCA OUT	OUT:M16x1,5
BICOS IN	
BICOS OUT	

**FC394S**



KIA

<b>OEM:</b>	
0K01120490B	
K01120490	
<b>EQUIVALÊNCIAS:</b>	
MANN	
MAHLE	
FRAM	G8116
WEGA	JFC394
TECFIL	
<b>MEDIDAS (mm):</b>	
COMPRIMENTO	149
D. INTERNO	
D. EXTERNO	72
ROSCA IN	
ROSCA OUT	
BICOS IN	IN:8
BICOS OUT	OUT:8

**FC397S**



MAZDA

<b>OEM:</b>	
KL0520490A	
KL0520490B	
<b>EQUIVALÊNCIAS:</b>	
MANN	WK614/1
MAHLE	KL121
FRAM	G5441
WEGA	JFC397
TECFIL	
<b>MEDIDAS (mm):</b>	
COMPRIMENTO	132
D. INTERNO	
D. EXTERNO	72
ROSCA IN	
ROSCA OUT	
BICOS IN	IN:8
BICOS OUT	OUT:8

**FC398S**



KIA

<b>OEM:</b>	
0K20120490	
MZT4220490	
<b>EQUIVALÊNCIAS:</b>	
MANN	WK614/9
MAHLE	KL115
FRAM	G7146
WEGA	JFC315
TECFIL	
<b>MEDIDAS (mm):</b>	
COMPRIMENTO	165
D. INTERNO	
D. EXTERNO	72
ROSCA IN	
ROSCA OUT	
BICOS IN	IN:8
BICOS OUT	OUT:8

**FC399S**



MAZDA

<b>OEM:</b>	
0K91220490B	
KF3320490	
<b>EQUIVALÊNCIAS:</b>	
MANN	WK614/42
MAHLE	KL120
FRAM	G7418
WEGA	JFC391
TECFIL	
<b>MEDIDAS (mm):</b>	
COMPRIMENTO	141
D. INTERNO	
D. EXTERNO	71,5
ROSCA IN	
ROSCA OUT	
BICOS IN	IN:8
BICOS OUT	OUT:8

**FC411S**



HONDA

<b>OEM:</b>	
16010SD4A50	
16010SD4Z01	
<b>EQUIVALÊNCIAS:</b>	
MANN	WK76/4
MAHLE	KL108
FRAM	G6826
WEGA	JFC411
TECFIL	
<b>MEDIDAS (mm):</b>	
COMPRIMENTO	94,5
D. INTERNO	
D. EXTERNO	86
ROSCA IN	IN:M14x1,5
ROSCA OUT	OUT:M12x1,25
BICOS IN	
BICOS OUT	

**FC413S**



HONDA

<b>OEM:</b>	
16010SH3931	
16010SH3C30	
<b>EQUIVALÊNCIAS:</b>	
MANN	WK76/3
MAHLE	
FRAM	G6534
WEGA	JFC413
TECFIL	
<b>MEDIDAS (mm):</b>	
COMPRIMENTO	94
D. INTERNO	
D. EXTERNO	86
ROSCA IN	IN:M12x1,25
ROSCA OUT	OUT:M12x1,25
BICOS IN	
BICOS OUT	

**FC415S**



HONDA

<b>OEM:</b>	
16010SF1A30	
16010SF1A31	
<b>EQUIVALÊNCIAS:</b>	
MANN	
MAHLE	KL562
FRAM	G6535
WEGA	
TECFIL	
<b>MEDIDAS (mm):</b>	
COMPRIMENTO	95
D. INTERNO	
D. EXTERNO	86
ROSCA IN	
ROSCA OUT	OUT:M12x1,25
BICOS IN	
BICOS OUT	

**FC418S**



LAND ROVER

<b>OEM:</b>	
16901S6FE02	
16901S37E30	
<b>EQUIVALÊNCIAS:</b>	
MANN	WK842/3
MAHLE	KL41
FRAM	P4836
WEGA	FCD2064
TECFIL	PSC498
<b>MEDIDAS (mm):</b>	
COMPRIMENTO	194
D. INTERNO	
D. EXTERNO	90,2
ROSCA IN	
ROSCA OUT	
BICOS IN	IN:8
BICOS OUT	OUT:8

**FC423S**



HONDA

<b>OEM:</b>	
16900S84G01	
<b>EQUIVALÊNCIAS:</b>	
MANN	WK611/6
MAHLE	KL510
FRAM	G9750
WEGA	JFC498/1
TECFIL	
<b>MEDIDAS (mm):</b>	
COMPRIMENTO	170
D. INTERNO	
D. EXTERNO	54
ROSCA IN	
ROSCA OUT	
BICOS IN	IN:9,5
BICOS OUT	OUT:8



HONDA	<b>FC425S</b>	OEM: 16010SAA000
	EQUIVALÊNCIAS:	
	MANN	
	MAHLE	
	FRAM	
WEGA	JFC453	
TECFIL		
MEDIDAS (mm):		
COMPRIMENTO	126	
D. INTERNO	42	
D. EXTERNO	107	
ROSCA IN		
ROSCA OUT		
BICOS IN		
BICOS OUT		



VW	<b>FC496S</b>	OEM: 191127401M 191127401E
	EQUIVALÊNCIAS:	
	MANN	WK842/4
	MAHLE	KL75
	FRAM	P5328
WEGA	FCD2067	
TECFIL	PSC498/1	
MEDIDAS (mm):		
COMPRIMENTO	164	
D. INTERNO		
D. EXTERNO	84	
ROSCA IN		
ROSCA OUT		
BICOS IN	IN:8	
BICOS OUT	OUT:8	



HONDA	<b>FC498S</b>	OEM: 16010ST5931 16010ST5932
	EQUIVALÊNCIAS:	
	MANN	WK68/1X
	MAHLE	KL185
	FRAM	G7599
WEGA	JFC498	
TECFIL	GI09	
MEDIDAS (mm):		
COMPRIMENTO	112,5	
D. INTERNO		
D. EXTERNO	75,4	
ROSCA IN	IN:M14x1,5	
ROSCA OUT	OUT:M12x1,25	
BICOS IN		
BICOS OUT		



SUZUKI	<b>FC499S</b>	OEM: 16900SLOA31 1541086501
	EQUIVALÊNCIAS:	
	MANN	
	MAHLE	
	FRAM	
WEGA		
TECFIL		
MEDIDAS (mm):		
COMPRIMENTO	96	
D. INTERNO		
D. EXTERNO	86	
ROSCA IN	IN:M12x1,25	
ROSCA OUT	OUT:M12x1,25	
BICOS IN		
BICOS OUT		



MITSUBISHI	<b>FC500S</b>	OEM: 1770A012
	EQUIVALÊNCIAS:	
	MANN	WK9023Z
	MAHLE	KC388D
	FRAM	P10357
WEGA	JFC500	
TECFIL		
MEDIDAS (mm):		
COMPRIMENTO	105	
D. INTERNO	73	
D. EXTERNO	106,5	
ROSCA IN	IN:20x1,5	
ROSCA OUT	OUT:34	
BICOS IN		
BICOS OUT		



MITSUBISHI	<b>FC501S</b>	OEM: 3191021000 4294623
	EQUIVALÊNCIAS:	
	MANN	WK42/11
	MAHLE	KL133
	FRAM	G4143
WEGA	JFC501	
TECFIL		
MEDIDAS (mm):		
COMPRIMENTO	88	
D. INTERNO	52,3	
D. EXTERNO		
ROSCA IN		
ROSCA OUT		
BICOS IN	IN:8	
BICOS OUT	OUT:8	



CHEVROLET / HYUNDAI / KIA / MITSUBISHI	<b>FC502S</b>	OEM: 145623570A 145623570A9A
	EQUIVALÊNCIAS:	
	MANN	WK940/11
	MAHLE	KC46
	FRAM	P4886
WEGA	JFC901	
TECFIL	PSC998	
MEDIDAS (mm):		
COMPRIMENTO	138	
D. INTERNO	73	
D. EXTERNO	98,4	
ROSCA IN	IN:M20x1,5	
ROSCA OUT	OUT:M36x1,5	
BICOS IN		
BICOS OUT		



CHEVROLET / HYUNDAI / KIA / MITSUBISHI	<b>FC502MP</b>	OEM: 145623570A 145623570A9A
	EQUIVALÊNCIAS:	
	MANN	WK940/11
	MAHLE	KC46
	FRAM	P4886
WEGA		
TECFIL	PSC998	
MEDIDAS (mm):		
COMPRIMENTO	137	
D. INTERNO	72	
D. EXTERNO	98	
ROSCA IN	IN:M20x1,5	
ROSCA OUT	OUT:34	
BICOS IN		
BICOS OUT		



DAIHATSU	<b>FC506S</b>	OEM: 2330079055 2330087614
	EQUIVALÊNCIAS:	
	MANN	WK614/2
	MAHLE	KL519
	FRAM	G6898
WEGA		
TECFIL		
MEDIDAS (mm):		
COMPRIMENTO	133	
D. INTERNO		
D. EXTERNO	72,1	
ROSCA IN	IN:M12x1,25	
ROSCA OUT	OUT:M12x1,25	
BICOS IN		
BICOS OUT		



KIA	<b>FC509S</b>	OEM: 2330087711 MB433425
	EQUIVALÊNCIAS:	
	MANN	WK815
	MAHLE	KC82
	FRAM	P5173
WEGA	JFC509	
TECFIL	PSC994	
MEDIDAS (mm):		
COMPRIMENTO	122	
D. INTERNO	62	
D. EXTERNO	82,6	
ROSCA IN	IN:M20x1,5	
ROSCA OUT	OUT:M22x1,5	
BICOS IN		
BICOS OUT		



**FC514S**

HYUNDAI / MITSUBISHI



<b>OEM:</b>	
3191122000 3191023500	
<b>EQUIVALÊNCIAS:</b>	
MANN	WK612/4
MAHLE	KL111
FRAM	G5603
WEGA	JFC514
TECFIL	
<b>MEDIDAS (mm):</b>	
COMPRIMENTO	119
D. INTERNO	
D. EXTERNO	70,5
ROSCA IN	IN:M14x1,5
ROSCA OUT	OUT:M12x1,25
BICOS IN	
BICOS OUT	

**FC518S**

DAIHATSU / HYUNDAI / MITSUBISHI



<b>OEM:</b>	
3191023000 MB504732	
<b>EQUIVALÊNCIAS:</b>	
MANN	WK614/31
MAHLE	KL127
FRAM	G6689
WEGA	JFC518
TECFIL	
<b>MEDIDAS (mm):</b>	
COMPRIMENTO	129
D. INTERNO	
D. EXTERNO	72
ROSCA IN	IN:M12x1,25
ROSCA OUT	OUT:M12x1,25
BICOS IN	
BICOS OUT	

**FC519S**

MITSUBISHI



<b>OEM:</b>	
MR212200	
<b>EQUIVALÊNCIAS:</b>	
MANN	WK68/83
MAHLE	KL749
FRAM	
WEGA	JFC519
TECFIL	
<b>MEDIDAS (mm):</b>	
COMPRIMENTO	125
D. INTERNO	
D. EXTERNO	65,5
ROSCA IN	
ROSCA OUT	OUT:M14x1,5
BICOS IN	IN:8
BICOS OUT	

**FC574S**

MITSUBISHI



<b>OEM:</b>	
ME132525	
<b>EQUIVALÊNCIAS:</b>	
MANN	WK940/37X
MAHLE	KC208
FRAM	P9529
WEGA	JFC574
TECFIL	
<b>MEDIDAS (mm):</b>	
COMPRIMENTO	140
D. INTERNO	73
D. EXTERNO	98
ROSCA IN	IN:M20x1,5
ROSCA OUT	OUT:M22x1,5
BICOS IN	
BICOS OUT	

**FC585S**

HYUNDAI



<b>OEM:</b>	
3191102100	
<b>EQUIVALÊNCIAS:</b>	
MANN	WK614/44
MAHLE	KL516
FRAM	G8864
WEGA	JFC585
TECFIL	
<b>MEDIDAS (mm):</b>	
COMPRIMENTO	123
D. INTERNO	
D. EXTERNO	70,7
ROSCA IN	IN:M14x1,5
ROSCA OUT	OUT:M14x1,5
BICOS IN	
BICOS OUT	

**FC590S**

MITSUBISHI / TOYOTA



<b>OEM:</b>	
MR204132 MB957348	
<b>EQUIVALÊNCIAS:</b>	
MANN	WK614/44
MAHLE	KL509
FRAM	G8075
WEGA	JFC590
TECFIL	
<b>MEDIDAS (mm):</b>	
COMPRIMENTO	104,5
D. INTERNO	
D. EXTERNO	64,5
ROSCA IN	IN:M14x1,5
ROSCA OUT	OUT:M12x1,25
BICOS IN	
BICOS OUT	

**FC594S**

HYUNDAI



<b>OEM:</b>	
3191129000	
<b>EQUIVALÊNCIAS:</b>	
MANN	WK614/10
MAHLE	KL508
FRAM	G8160
WEGA	JFC594
TECFIL	
<b>MEDIDAS (mm):</b>	
COMPRIMENTO	105,3
D. INTERNO	
D. EXTERNO	70
ROSCA IN	IN:M14x1,5
ROSCA OUT	OUT:11
BICOS IN	
BICOS OUT	

**FC598S**

HONDA



<b>OEM:</b>	
3191023000 3191136000	
<b>EQUIVALÊNCIAS:</b>	
MANN	WK614/3X
MAHLE	KL130
FRAM	G5257
WEGA	JFC511
TECFIL	
<b>MEDIDAS (mm):</b>	
COMPRIMENTO	129
D. INTERNO	
D. EXTERNO	70
ROSCA IN	IN:M12x1,25
ROSCA OUT	OUT:M12x1,25
BICOS IN	
BICOS OUT	

**FC614S**

DAIHATSU



<b>OEM:</b>	
2330087719	
<b>EQUIVALÊNCIAS:</b>	
MANN	
MAHLE	
FRAM	G5452
WEGA	JFC614
TECFIL	
<b>MEDIDAS (mm):</b>	
COMPRIMENTO	114
D. INTERNO	
D. EXTERNO	58
ROSCA IN	
ROSCA OUT	
BICOS IN	IN:7
BICOS OUT	OUT:8

**FC620S**

DAIHATSU



<b>OEM:</b>	
2330087102 2330087103	
<b>EQUIVALÊNCIAS:</b>	
MANN	WK614/29
MAHLE	
FRAM	
WEGA	JFC620
TECFIL	
<b>MEDIDAS (mm):</b>	
COMPRIMENTO	150
D. INTERNO	
D. EXTERNO	71
ROSCA IN	
ROSCA OUT	OUT:M12x1,25
BICOS IN	IN:8
BICOS OUT	



**FC692S**

**DAIHATSU**



<b>OEM:</b>	
2330087403 2330087402	
<b>EQUIVALÊNCIAS:</b>	
MANN	WK614/19
MAHLE	KL518
FRAM	G8836
WEGA	JFC692
TECFIL	
<b>MEDIDAS (mm):</b>	
COMPRIMENTO	134
D. INTERNO	
D. EXTERNO	71
ROSCA IN	
ROSCA OUT	
BICOS IN	IN:8
BICOS OUT	OUT:8

**FC693S**

**DAIHATSU**



<b>OEM:</b>	
2330087625 2330087625000	
<b>EQUIVALÊNCIAS:</b>	
MANN	
MAHLE	KL519
FRAM	
WEGA	
TECFIL	
<b>MEDIDAS (mm):</b>	
COMPRIMENTO	134
D. INTERNO	
D. EXTERNO	71
ROSCA IN	IN:M12x1,25
ROSCA OUT	
BICOS IN	
BICOS OUT	OUT:8

**FC694S**

**DAIHATSU**



<b>OEM:</b>	
2330087214 2330087214LOC	
<b>EQUIVALÊNCIAS:</b>	
MANN	WK56/2
MAHLE	KL578
FRAM	G8835
WEGA	JFC694
TECFIL	
<b>MEDIDAS (mm):</b>	
COMPRIMENTO	103
D. INTERNO	
D. EXTERNO	71
ROSCA IN	
ROSCA OUT	
BICOS IN	IN:8
BICOS OUT	OUT:8

**FC695S**

**FIAT / FORD / VW**



<b>OEM:</b>	
WE4T9W365B 1457434106	
<b>EQUIVALÊNCIAS:</b>	
MANN	WK842/7
MAHLE	KC17D
FRAM	P4587
WEGA	FCD2058
TECFIL	PSC496
<b>MEDIDAS (mm):</b>	
COMPRIMENTO	154,5
D. INTERNO	71
D. EXTERNO	86
ROSCA IN	M16x1,5
ROSCA OUT	
BICOS IN	
BICOS OUT	

**FC701S**

**SUBARU**



<b>OEM:</b>	
42072AE000	
<b>EQUIVALÊNCIAS:</b>	
MANN	
MAHLE	
FRAM	
WEGA	JFC701
TECFIL	
<b>MEDIDAS (mm):</b>	
COMPRIMENTO	92
D. INTERNO	24,4 / 30
D. EXTERNO	46,4
ROSCA IN	
ROSCA OUT	
BICOS IN	
BICOS OUT	

**FC707S**

**SUBARU**



<b>OEM:</b>	
42072AA011 42072AA010	
<b>EQUIVALÊNCIAS:</b>	
MANN	WK711
MAHLE	KL134
FRAM	G6827
WEGA	JFC708
TECFIL	
<b>MEDIDAS (mm):</b>	
COMPRIMENTO	121
D. INTERNO	
D. EXTERNO	86
ROSCA IN	
ROSCA OUT	
BICOS IN	IN:8
BICOS OUT	OUT:8

**FC797S**

**SUBARU**



<b>OEM:</b>	
42072KC030	
<b>EQUIVALÊNCIAS:</b>	
MANN	WK614/18
MAHLE	
FRAM	G5973
WEGA	JFC797
TECFIL	
<b>MEDIDAS (mm):</b>	
COMPRIMENTO	113,4
D. INTERNO	
D. EXTERNO	71
ROSCA IN	
ROSCA OUT	
BICOS IN	IN:8
BICOS OUT	OUT:8

**FC810S**

**SUZUKI**



<b>OEM:</b>	
1541060B01 1541060B00	
<b>EQUIVALÊNCIAS:</b>	
MANN	WK76
MAHLE	KL521
FRAM	G6677
WEGA	JFC810
TECFIL	
<b>MEDIDAS (mm):</b>	
COMPRIMENTO	103
D. INTERNO	
D. EXTERNO	86
ROSCA IN	
ROSCA OUT	
BICOS IN	IN:8
BICOS OUT	OUT:8

**FC823S**

**CHEVROLET / SUZUKI**



<b>OEM:</b>	
1541065D00 1541065D10	
<b>EQUIVALÊNCIAS:</b>	
MANN	WK614/47
MAHLE	KL523
FRAM	G5982
WEGA	JFC823
TECFIL	
<b>MEDIDAS (mm):</b>	
COMPRIMENTO	135
D. INTERNO	
D. EXTERNO	72
ROSCA IN	
ROSCA OUT	
BICOS IN	IN:8
BICOS OUT	OUT:8

**FC826S**

**SUZUKI**



<b>OEM:</b>	
1541052D00	
<b>EQUIVALÊNCIAS:</b>	
MANN	
MAHLE	
FRAM	
WEGA	
TECFIL	
<b>MEDIDAS (mm):</b>	
COMPRIMENTO	128
D. INTERNO	
D. EXTERNO	71
ROSCA IN	
ROSCA OUT	
BICOS IN	IN:8
BICOS OUT	OUT:8

**FC887S**



**SUZUKI**

<b>OEM:</b>	
1541080C00 31976-43670	
<b>EQUIVALÊNCIAS:</b>	
MANN	WK614/28
MAHLE	KL203
FRAM	G7196
WEGA	JFC597
TECFIL	GI07/1
<b>MEDIDAS (mm):</b>	
COMPRIMENTO	130
D. INTERNO	
D. EXTERNO	71
ROSCA IN	M12x1,25
ROSCA OUT	
BICOS IN	
BICOS OUT	

**FC896S**



**SUZUKI**

<b>OEM:</b>	
1541060G00 1541062G00	
<b>EQUIVALÊNCIAS:</b>	
MANN	WK710
MAHLE	KL136
FRAM	G5690
WEGA	JFC896
TECFIL	
<b>MEDIDAS (mm):</b>	
COMPRIMENTO	107,3
D. INTERNO	
D. EXTERNO	75,7
ROSCA IN	
ROSCA OUT	
BICOS IN	IN:8
BICOS OUT	OUT:8

**FC897S**



**SUZUKI**

<b>OEM:</b>	
1541072F00 1541072F01	
<b>EQUIVALÊNCIAS:</b>	
MANN	WK710/1
MAHLE	
FRAM	G5974
WEGA	JFC897
TECFIL	
<b>MEDIDAS (mm):</b>	
COMPRIMENTO	100
D. INTERNO	
D. EXTERNO	70
ROSCA IN	
ROSCA OUT	
BICOS IN	IN:8
BICOS OUT	OUT:8

**FC909S**



**AUDI / CITROËN / FIAT / PEUGEOT**

<b>OEM:</b>	
25126130 7612972	
<b>EQUIVALÊNCIAS:</b>	
MANN	WK613
MAHLE	KL60
FRAM	G6400
WEGA	FC1101A
TECFIL	GI03/1
<b>MEDIDAS (mm):</b>	
COMPRIMENTO	127
D. INTERNO	
D. EXTERNO	59,3
ROSCA IN	
ROSCA OUT	
BICOS IN	IN:8
BICOS OUT	OUT:8

**FC912S**



**JEEP**

<b>OEM:</b>	
52100283AD	
<b>EQUIVALÊNCIAS:</b>	
MANN	
MAHLE	
FRAM	
WEGA	FCI0823
TECFIL	
<b>MEDIDAS (mm):</b>	
COMPRIMENTO	172
D. INTERNO	
D. EXTERNO	54
ROSCA IN	
ROSCA OUT	
BICOS IN	IN:8
BICOS OUT	OUT:9,5

**FC988S**



**JEEP / MB**

<b>OEM:</b>	
05080477AA	
<b>EQUIVALÊNCIAS:</b>	
MANN	WK842/18
MAHLE	KL174
FRAM	PS9514
WEGA	FCD2158
TECFIL	
<b>MEDIDAS (mm):</b>	
COMPRIMENTO	119
D. INTERNO	
D. EXTERNO	90
ROSCA IN	
ROSCA OUT	
BICOS IN	IN:8
BICOS OUT	OUT:10

**FC991S**



**MB / SSANGYOUNG**

<b>OEM:</b>	
2319005320 6610903055	
<b>EQUIVALÊNCIAS:</b>	
MANN	WK817/3X
MAHLE	KC63/1D
FRAM	P4549A
WEGA	FCD2069
TECFIL	PSC401
<b>MEDIDAS (mm):</b>	
COMPRIMENTO	103
D. INTERNO	70
D. EXTERNO	85,6
ROSCA IN	M12x1,5
ROSCA OUT	
BICOS IN	
BICOS OUT	

**FC995S**



**DODGE / JEEP**

<b>OEM:</b>	
4798166 4798166	
<b>EQUIVALÊNCIAS:</b>	
MANN	
MAHLE	KC219
FRAM	P8833
WEGA	JFC995
TECFIL	
<b>MEDIDAS (mm):</b>	
COMPRIMENTO	70
D. INTERNO	108,3 / 90
D. EXTERNO	
ROSCA IN	IN:1"x14
ROSCA OUT	OUT:1"x14
BICOS IN	
BICOS OUT	

**FC997S**



**DODGE / JEEP**

<b>OEM:</b>	
4723905	
<b>EQUIVALÊNCIAS:</b>	
MANN	WK924/1X
MAHLE	KC238D
FRAM	P9486
WEGA	JFC997
TECFIL	
<b>MEDIDAS (mm):</b>	
COMPRIMENTO	104
D. INTERNO	89
D. EXTERNO	96,2
ROSCA IN	IN:1"x14
ROSCA OUT	OUT:77,6
BICOS IN	
BICOS OUT	

**FC999S**



**JEEP**

<b>OEM:</b>	
8983501902	
<b>EQUIVALÊNCIAS:</b>	
MANN	
MAHLE	
FRAM	P3940A
WEGA	JFC999
TECFIL	
<b>MEDIDAS (mm):</b>	
COMPRIMENTO	161
D. INTERNO	
D. EXTERNO	
ROSCA IN	IN:7,0
ROSCA OUT	OUT:7,0
BICOS IN	
BICOS OUT	



**FC2010S**

ALFA ROMEO / AUDI / JAGUAR / VOLVO



OEM:	
431133511D 1276864	
EQUIVALÊNCIAS:	
MANN	WK830/6
MAHLE	KL204
FRAM	G3747
WEGA	FCI1107A
TECFIL	
MEDIDAS (mm):	
COMPRIMENTO	130
D. INTERNO	
D. EXTERNO	82,6
ROSCA IN	IN:M12x1,5
ROSCA OUT	OUT:M14x1,5
BICOS IN	
BICOS OUT	

**FC2011S**

AUDI / VOLVO



OEM:	
1289562 13065305	
EQUIVALÊNCIAS:	
MANN	WK853
MAHLE	KL30
FRAM	G3744
WEGA	FCI1104A
TECFIL	
MEDIDAS (mm):	
COMPRIMENTO	155
D. INTERNO	
D. EXTERNO	87,5
ROSCA IN	IN:M12x1,5
ROSCA OUT	OUT:M14x1,5
BICOS IN	
BICOS OUT	

**FC2015S**

BMW / MB



OEM:	
14770301 14775901	
EQUIVALÊNCIAS:	
MANN	WK830/3
MAHLE	KL19
FRAM	G3736
WEGA	FCI1106A
TECFIL	
MEDIDAS (mm):	
COMPRIMENTO	147
D. INTERNO	
D. EXTERNO	82,6
ROSCA IN	IN:M12x1,5
ROSCA OUT	OUT:M14x1,5
BICOS IN	
BICOS OUT	

**FC2026S**

AUDI



OEM:	
433133511 443133511C	
EQUIVALÊNCIAS:	
MANN	WK834/1
MAHLE	KL28
FRAM	G6398
WEGA	FCI1104C
TECFIL	
MEDIDAS (mm):	
COMPRIMENTO	175
D. INTERNO	
D. EXTERNO	87,5
ROSCA IN	IN:M12x1,5
ROSCA OUT	OUT:M14x1,5
BICOS IN	
BICOS OUT	

**FC2027S**

MB



OEM:	
24774401 24771301	
EQUIVALÊNCIAS:	
MANN	WK845
MAHLE	KL38
FRAM	G3737
WEGA	FCI1110B
TECFIL	
MEDIDAS (mm):	
COMPRIMENTO	167
D. INTERNO	
D. EXTERNO	90,5
ROSCA IN	IN:M12x1,5
ROSCA OUT	OUT:M14x1,5
BICOS IN	
BICOS OUT	

**FC2028S**

BMW



OEM:	
13321720102 13321720101	
EQUIVALÊNCIAS:	
MANN	WK516
MAHLE	KL35
FRAM	G6574
WEGA	FCI1731
TECFIL	
MEDIDAS (mm):	
COMPRIMENTO	205
D. INTERNO	
D. EXTERNO	55
ROSCA IN	
ROSCA OUT	
BICOS IN	IN:8
BICOS OUT	OUT:8

**FC2029S**

BMW



OEM:	
13321702632 13321740985	
EQUIVALÊNCIAS:	
MANN	WK516/1
MAHLE	KL66
FRAM	G5774
WEGA	FCI1732
TECFIL	GI17
MEDIDAS (mm):	
COMPRIMENTO	300
D. INTERNO	
D. EXTERNO	55
ROSCA IN	
ROSCA OUT	
BICOS IN	IN:8
BICOS OUT	OUT:8

**FC2031S**

VOLVO



OEM:	
35074160 91426585	
EQUIVALÊNCIAS:	
MANN	WK849
MAHLE	KL85
FRAM	G7736
WEGA	FCI1866
TECFIL	
MEDIDAS (mm):	
COMPRIMENTO	194
D. INTERNO	
D. EXTERNO	88
ROSCA IN	
ROSCA OUT	
BICOS IN	IN:8
BICOS OUT	OUT:8

**FC2036S**

AUDI / VW



OEM:	
1J0201511A 3D0201511	
EQUIVALÊNCIAS:	
MANN	WK730/1
MAHLE	KL79
FRAM	G5870
WEGA	FCI1288
TECFIL	GI10
MEDIDAS (mm):	
COMPRIMENTO	171
D. INTERNO	
D. EXTERNO	74
ROSCA IN	
ROSCA OUT	
BICOS IN	IN:8
BICOS OUT	OUT:8

**FC2040S**

CHRYSLER / CRYSLER



OEM:	
24773101 05097052AA	
EQUIVALÊNCIAS:	
MANN	WK720
MAHLE	KL82
FRAM	G9526
WEGA	FCI1948
TECFIL	
MEDIDAS (mm):	
COMPRIMENTO	162
D. INTERNO	
D. EXTERNO	74,6
ROSCA IN	
ROSCA OUT	
BICOS IN	IN:6/8
BICOS OUT	OUT:8/10

**FC2043S**

**BMW**



<b>OEM:</b>	
13321407299	
13327831089	
<b>EQUIVALÊNCIAS:</b>	
MANN	WK516/2
MAHLE	KL104
FRAM	
WEGA	FCI1736
TECFIL	
<b>MEDIDAS (mm):</b>	
COMPRIMENTO	325
D. INTERNO	
D. EXTERNO	55
ROSCA IN	
ROSCA OUT	
BICOS IN	IN:8
BICOS OUT	OUT:M12x1,5

**FC2045S**

**BMW**



<b>OEM:</b>	
13321709535	
FS9132E	
<b>EQUIVALÊNCIAS:</b>	
MANN	WK532
MAHLE	KL96
FRAM	G9334
WEGA	FCI1733
TECFIL	
<b>MEDIDAS (mm):</b>	
COMPRIMENTO	310
D. INTERNO	
D. EXTERNO	55
ROSCA IN	IN:M12x1,5
ROSCA OUT	OUT:M14x1,5
BICOS IN	
BICOS OUT	

**FC2072S**

**AUDI / BMW / PEUGEOT / VW**



<b>OEM:</b>	
7212351	
1H0201511	
<b>EQUIVALÊNCIAS:</b>	
MANN	WK830
MAHLE	KL2
FRAM	
WEGA	FCI1105A
TECFIL	GI01/1
<b>MEDIDAS (mm):</b>	
COMPRIMENTO	159
D. INTERNO	
D. EXTERNO	81
ROSCA IN	
ROSCA OUT	
BICOS IN	IN:9,5
BICOS OUT	OUT:9,5

**FC2074S**

**VOLVO**



<b>OEM:</b>	
30817997	
<b>EQUIVALÊNCIAS:</b>	
MANN	WK850
MAHLE	KL71
FRAM	G5869
WEGA	FCI1866/1
TECFIL	
<b>MEDIDAS (mm):</b>	
COMPRIMENTO	211
D. INTERNO	
D. EXTERNO	86
ROSCA IN	
ROSCA OUT	
BICOS IN	IN:7,9
BICOS OUT	OUT:7,9

**FC2140S**

**AUDI**



<b>OEM:</b>	
8E0201511F	
8E0201511G	
<b>EQUIVALÊNCIAS:</b>	
MANN	WK720/6
MAHLE	
FRAM	G10819
WEGA	
TECFIL	
<b>MEDIDAS (mm):</b>	
COMPRIMENTO	183
D. INTERNO	
D. EXTERNO	74,5
ROSCA IN	
ROSCA OUT	
BICOS IN	
BICOS OUT	

**FC2243S**

**AUDI**



<b>OEM:</b>	
4F0201511A	
4F0201511C	
<b>EQUIVALÊNCIAS:</b>	
MANN	WK720/4
MAHLE	KL571
FRAM	G10215
WEGA	FCI1290
TECFIL	
<b>MEDIDAS (mm):</b>	
COMPRIMENTO	176
D. INTERNO	
D. EXTERNO	74
ROSCA IN	
ROSCA OUT	
BICOS IN	IN:8
BICOS OUT	OUT:8

**FC2244S**

**AUDI / VW**



<b>OEM:</b>	
1K0201051C	
1K0201051B	
<b>EQUIVALÊNCIAS:</b>	
MANN	WK69
MAHLE	KL572
FRAM	G10243
WEGA	FCI1304
TECFIL	
<b>MEDIDAS (mm):</b>	
COMPRIMENTO	163
D. INTERNO	
D. EXTERNO	61,5
ROSCA IN	
ROSCA OUT	
BICOS IN	IN:7,9
BICOS OUT	OUT:7,9

**FC2245S**

**VW**



<b>OEM:</b>	
6Q0201051A	
6Q0201051C	
<b>EQUIVALÊNCIAS:</b>	
MANN	WK69/2
MAHLE	
FRAM	G10142
WEGA	FCI1303
TECFIL	
<b>MEDIDAS (mm):</b>	
COMPRIMENTO	163
D. INTERNO	
D. EXTERNO	61,5
ROSCA IN	
ROSCA OUT	
BICOS IN	IN:7,9
BICOS OUT	OUT:7,9

**FC2343S**

**AUDI**



<b>OEM:</b>	
4F0201511D	
4F0201511B	
<b>EQUIVALÊNCIAS:</b>	
MANN	WK720/3
MAHLE	KL570
FRAM	G10214
WEGA	
TECFIL	
<b>MEDIDAS (mm):</b>	
COMPRIMENTO	176
D. INTERNO	
D. EXTERNO	82,5
ROSCA IN	
ROSCA OUT	
BICOS IN	IN:13
BICOS OUT	OUT:7,9

**FC4010S**

**CITROËN / PEUGEOT / RENAULT**



<b>OEM:</b>	
156793	
156774	
<b>EQUIVALÊNCIAS:</b>	
MANN	WK612
MAHLE	KL72
FRAM	G5857
WEGA	FCI1101C
TECFIL	GI50
<b>MEDIDAS (mm):</b>	
COMPRIMENTO	136,5
D. INTERNO	
D. EXTERNO	55
ROSCA IN	
ROSCA OUT	
BICOS IN	IN:7
BICOS OUT	OUT:7



**FC4645S**

CADILLAC / GMC



OEM:	
25168251	
25168594	
EQUIVALÊNCIAS:	
MANN	WK611/5
MAHLE	
FRAM	G8219
WEGA	FCI1118
TECFIL	GI11
MEDIDAS (mm):	
COMPRIMENTO	138
D. INTERNO	
D. EXTERNO	54,7
ROSCA IN	IN:M16x1,5
ROSCA OUT	
BICOS IN	
BICOS OUT	OUT:9,5

**FC4682S**

DODGE



OEM:	
4809117AB	
4682569	
EQUIVALÊNCIAS:	
MANN	
MAHLE	KL544
FRAM	
WEGA	FCI1102/3
TECFIL	
MEDIDAS (mm):	
COMPRIMENTO	745
D. INTERNO	
D. EXTERNO	159
ROSCA IN	
ROSCA OUT	
BICOS IN	5/16
BICOS OUT	3/8

**FC4683S**

DODGE



OEM:	
4809118AB	
4682370	
EQUIVALÊNCIAS:	
MANN	
MAHLE	KL553
FRAM	
WEGA	FCI1102/2
TECFIL	
MEDIDAS (mm):	
COMPRIMENTO	950
D. INTERNO	
D. EXTERNO	159
ROSCA IN	
ROSCA OUT	
BICOS IN	5/16
BICOS OUT	3/8

**FC4688S**

CHRYSLER / DODGE



OEM:	
4809118AC	
4809118AD	
EQUIVALÊNCIAS:	
MANN	
MAHLE	KL553
FRAM	G9272
WEGA	
TECFIL	
MEDIDAS (mm):	
COMPRIMENTO	755
D. INTERNO	
D. EXTERNO	159
ROSCA IN	
ROSCA OUT	
BICOS IN	
BICOS OUT	

**FC6150S**

DODGE



OEM:	
4495950	
4546679	
EQUIVALÊNCIAS:	
MANN	WK57/2
MAHLE	
FRAM	G8073
WEGA	FCI1101/4
TECFIL	
MEDIDAS (mm):	
COMPRIMENTO	233
D. INTERNO	
D. EXTERNO	54,5
ROSCA IN	
ROSCA OUT	
BICOS IN	
BICOS OUT	

**FC6160S**

DODGE



OEM:	
4695049	
EQUIVALÊNCIAS:	
MANN	
MAHLE	
FRAM	G7760
WEGA	FCI1102/1
TECFIL	
MEDIDAS (mm):	
COMPRIMENTO	224
D. INTERNO	
D. EXTERNO	54,5
ROSCA IN	
ROSCA OUT	
BICOS IN	
BICOS OUT	

**FC6220S**

DODGE



OEM:	
4764210	
04764210	
EQUIVALÊNCIAS:	
MANN	
MAHLE	
FRAM	G9041
WEGA	FCI1102
TECFIL	
MEDIDAS (mm):	
COMPRIMENTO	207
D. INTERNO	
D. EXTERNO	54,7
ROSCA IN	
ROSCA OUT	
BICOS IN	5/16
BICOS OUT	3/8

**FC8800S**

FORD / LINCOLN



OEM:	
E83C9B072AA	
E3E9155CB	
EQUIVALÊNCIAS:	
MANN	WK712/4
MAHLE	KL224
FRAM	G3802A
WEGA	FCI1880
TECFIL	GI06/1
MEDIDAS (mm):	
COMPRIMENTO	138
D. INTERNO	
D. EXTERNO	82
ROSCA IN	
ROSCA OUT	
BICOS IN	IN:8
BICOS OUT	OUT:8

**FC8860S**

FORD / LINCOLN



OEM:	
25055302	
25313817	
EQUIVALÊNCIAS:	
MANN	WK78/2
MAHLE	
FRAM	G3850
WEGA	FCI1872
TECFIL	GI06/7
MEDIDAS (mm):	
COMPRIMENTO	171
D. INTERNO	
D. EXTERNO	82
ROSCA IN	
ROSCA OUT	
BICOS IN	IN:8
BICOS OUT	OUT:8

**FC8870S**

FORD



OEM:	
F3T29155AFFV	
F3T29155AFFV	
EQUIVALÊNCIAS:	
MANN	
MAHLE	KL223
FRAM	G7649
WEGA	FCI1887
TECFIL	GI07/1
MEDIDAS (mm):	
COMPRIMENTO	172
D. INTERNO	
D. EXTERNO	82
ROSCA IN	
ROSCA OUT	
BICOS IN	IN:8
BICOS OUT	OUT:8

**FC8900S**

CADILLAC / FORD / JAGUAR / LINCOLN



<b>OEM:</b>	
F89Z9155AA XF5Z9155BA	
<b>EQUIVALÊNCIAS:</b>	
MANN	WK512/1
MAHLE	KL84
FRAM	G9412
WEGA	FCI1881
TECFIL	
<b>MEDIDAS (mm):</b>	
COMPRIMENTO	178
D. INTERNO	
D. EXTERNO	56
ROSCA IN	
ROSCA OUT	
BICOS IN	IN:8
BICOS OUT	OUT:8

**FC8920S**

FORD / LINCOLN



<b>OEM:</b>	
1F7013470A 2L2Z9155AB	
<b>EQUIVALÊNCIAS:</b>	
MANN	
MAHLE	
FRAM	G9343
WEGA	
TECFIL	
<b>MEDIDAS (mm):</b>	
COMPRIMENTO	179
D. INTERNO	
D. EXTERNO	57
ROSCA IN	
ROSCA OUT	
BICOS IN	
BICOS OUT	

**FC8940S**

FORD / LINCOLN



<b>OEM:</b>	
2C5Z9155AA 2C5Z9155BC	
<b>EQUIVALÊNCIAS:</b>	
MANN	MF1027
MAHLE	
FRAM	G10166
WEGA	FCI1883
TECFIL	
<b>MEDIDAS (mm):</b>	
COMPRIMENTO	171
D. INTERNO	
D. EXTERNO	49
ROSCA IN	
ROSCA OUT	
BICOS IN	
BICOS OUT	

**FC9020S**

VOLVO



<b>OEM:</b>	
30620512	
<b>EQUIVALÊNCIAS:</b>	
MANN	WK822/2
MAHLE	KL196
FRAM	G9552
WEGA	FCI1866/2
TECFIL	
<b>MEDIDAS (mm):</b>	
COMPRIMENTO	163
D. INTERNO	
D. EXTERNO	90
ROSCA IN	
ROSCA OUT	
BICOS IN	IN:8
BICOS OUT	OUT:8

**FC9030S**

VOLVO



<b>OEM:</b>	
30636704	
<b>EQUIVALÊNCIAS:</b>	
MANN	WK832/2
MAHLE	KL257
FRAM	
WEGA	FCI1866/3
TECFIL	
<b>MEDIDAS (mm):</b>	
COMPRIMENTO	175
D. INTERNO	
D. EXTERNO	88
ROSCA IN	
ROSCA OUT	
BICOS IN	
BICOS OUT	

**FCBR2S**

VW CAMINHÕES



<b>OEM:</b>	
2PO127401	
<b>EQUIVALÊNCIAS:</b>	
MANN	WK10002
MAHLE	KL422
FRAM	
WEGA	FCD2060
TECFIL	PSC453
<b>MEDIDAS (mm):</b>	
COMPRIMENTO	220
D. INTERNO	
D. EXTERNO	86
ROSCA IN	
ROSCA OUT	
BICOS IN	M10x1,5
BICOS OUT	

**FCBR3S**

FORD



<b>OEM:</b>	
BG5T9W155AA 72136	
<b>EQUIVALÊNCIAS:</b>	
MANN	WK846
MAHLE	KL425
FRAM	
WEGA	FCD2061
TECFIL	PSC451
<b>MEDIDAS (mm):</b>	
COMPRIMENTO	184
D. INTERNO	
D. EXTERNO	80
ROSCA IN	
ROSCA OUT	
BICOS IN	M8x1,25
BICOS OUT	

**FCBR4S**

FORD



<b>OEM:</b>	
B61T9155CA B61T9155CA	
<b>EQUIVALÊNCIAS:</b>	
MANN	WK853/15
MAHLE	
FRAM	P9903
WEGA	FCD2062
TECFIL	PSC498/2
<b>MEDIDAS (mm):</b>	
COMPRIMENTO	139
D. INTERNO	
D. EXTERNO	86,4
ROSCA IN	
ROSCA OUT	
BICOS IN	
BICOS OUT	

**FCBR5S**

NISSAN



<b>OEM:</b>	
905411510035 905410500105	
<b>EQUIVALÊNCIAS:</b>	
MANN	
MAHLE	KL428
FRAM	
WEGA	
TECFIL	
<b>MEDIDAS (mm):</b>	
COMPRIMENTO	153
D. INTERNO	
D. EXTERNO	93
ROSCA IN	
ROSCA OUT	
BICOS IN	
BICOS OUT	

**FCBR7S**

CITROËN



<b>OEM:</b>	
99419058 1902138	
<b>EQUIVALÊNCIAS:</b>	
MANN	WK842
MAHLE	KC18
FRAM	P4183
WEGA	FCD2058B
TECFIL	PSC496
<b>MEDIDAS (mm):</b>	
COMPRIMENTO	155,5
D. INTERNO	61
D. EXTERNO	81
ROSCA IN	
ROSCA OUT	
BICOS IN	
BICOS OUT	



### FCBR8S

AUDI / VW / SEAT



**OEM:**  
6Q0201511  
6Q0201511

**EQUIVALÊNCIAS:**

MANN	WK59X
MAHLE	KL176/6D
FRAM	G9791
WEGA	FCI1300
TECFIL	GI14

**MEDIDAS (mm):**

COMPRIMENTO	150,3
D. INTERNO	7,89
D. EXTERNO	61
ROSCA IN	
ROSCA OUT	
BICOS IN	8
BICOS OUT	

### FCBR8/1S

AUDI / VW



**OEM:**  
6Q0201051B  
6Q0201512

**EQUIVALÊNCIAS:**

MANN	WK69/1
MAHLE	KL176
FRAM	G10146
WEGA	FCI1301
TECFIL	

**MEDIDAS (mm):**

COMPRIMENTO	165
D. INTERNO	
D. EXTERNO	61
ROSCA IN	
ROSCA OUT	
BICOS IN	8
BICOS OUT	

### FCBR09S

CHEVROLET / FORD / NISSAN



**OEM:**  
BF5T9155BA  
905400150018

**EQUIVALÊNCIAS:**

MANN	WK842/14
MAHLE	KL316
FRAM	P10707
WEGA	FCD2064
TECFIL	PSC498/3

**MEDIDAS (mm):**

COMPRIMENTO	146
D. INTERNO	
D. EXTERNO	82
ROSCA IN	M10x1,5
ROSCA OUT	
BICOS IN	8
BICOS OUT	

### FCBR10S

CHEVROLET / FIAT / FORD / VW



**OEM:**  
377133511A

**EQUIVALÊNCIAS:**

MANN	WK613/3
MAHLE	KL237/1
FRAM	G5738
WEGA	FCI1620
TECFIL	GI08/1

**MEDIDAS (mm):**

COMPRIMENTO	175
D. INTERNO	
D. EXTERNO	75
ROSCA IN	
ROSCA OUT	
BICOS IN	9,5
BICOS OUT	

### FCBR11S

CHEVROLET / FORD



**OEM:**  
E7DE9155AA

**EQUIVALÊNCIAS:**

MANN	WK712/4
MAHLE	KL224/1
FRAM	G5980
WEGA	FCI1650
TECFIL	GI06/1

**MEDIDAS (mm):**

COMPRIMENTO	180
D. INTERNO	
D. EXTERNO	75
ROSCA IN	
ROSCA OUT	
BICOS IN	8
BICOS OUT	

### FCBR12S

FORD / VW



**OEM:**  
3251335111  
F4FF9155AV

**EQUIVALÊNCIAS:**

MANN	WK613/4
MAHLE	KL223/1
FRAM	G8781
WEGA	FCI1640
TECFIL	GI07/1

**MEDIDAS (mm):**

COMPRIMENTO	180
D. INTERNO	
D. EXTERNO	75
ROSCA IN	
ROSCA OUT	
BICOS IN	IN:9,5
BICOS OUT	OUT:7,9

### FCBR13S

CHEVROLET / VW



**OEM:**  
25126130  
7612972

**EQUIVALÊNCIAS:**

MANN	WK613/1
MAHLE	KL60/2
FRAM	G5312
WEGA	FCI1680
TECFIL	GI02/2

**MEDIDAS (mm):**

COMPRIMENTO	93
D. INTERNO	
D. EXTERNO	64
ROSCA IN	
ROSCA OUT	
BICOS IN	8
BICOS OUT	

### FCBR14S

FIAT / MITSUBISHI / TOYOTA / VW



**OEM:**  
25161062  
CA130085

**EQUIVALÊNCIAS:**

MANN	WK58
MAHLE	KL582
FRAM	G10225F
WEGA	FCI1698
TECFIL	GI04/7

**MEDIDAS (mm):**

COMPRIMENTO	140
D. INTERNO	
D. EXTERNO	55/62
ROSCA IN	
ROSCA OUT	
BICOS IN	8
BICOS OUT	

### FCBR15S

CHEVROLET



**OEM:**  
25121307

**EQUIVALÊNCIAS:**

MANN	WK47/1
MAHLE	KL225
FRAM	G5471
WEGA	FCI0363
TECFIL	GI02/1

**MEDIDAS (mm):**

COMPRIMENTO	149
D. INTERNO	
D. EXTERNO	55/62
ROSCA IN	
ROSCA OUT	
BICOS IN	IN:8,1
BICOS OUT	OUT:9,5

### FCBR16S

CHEVROLET



**OEM:**  
25161062  
96335719

**EQUIVALÊNCIAS:**

MANN	
MAHLE	
FRAM	G9890F
WEGA	FCI1660
TECFIL	

**MEDIDAS (mm):**

COMPRIMENTO	140
D. INTERNO	
D. EXTERNO	55
ROSCA IN	
ROSCA OUT	
BICOS IN	8
BICOS OUT	

**FCBR17S**

**OEM:**  
7212351  
1H0201511

**EQUIVALÊNCIAS:**

MANN	WK58
MAHLE	kl583
FRAM	G10230F
WEGA	FC11630
TECFIL	GI50/7

**MEDIDAS (mm):**

COMPRIMENTO	136
D. INTERNO	
D. EXTERNO	55/62
ROSCA IN	
ROSCA OUT	
BICOS IN	8
BICOS OUT	

CITROËN / NISSAN / PEUGEOT / RENAULT / VW

**FCBR18S**

**OEM:**  
46416684  
7083750

**EQUIVALÊNCIAS:**

MANN	WK510
MAHLE	KL238
FRAM	G7729
WEGA	FC11600
TECFIL	GI41

**MEDIDAS (mm):**

COMPRIMENTO	175
D. INTERNO	
D. EXTERNO	50
ROSCA IN	
ROSCA OUT	
BICOS IN	9
BICOS OUT	

FIAT

**FCBR19S**

**OEM:**  
50015864  
50004949

**EQUIVALÊNCIAS:**

MANN	WK513
MAHLE	KL239/1
FRAM	G5493
WEGA	FC11610
TECFIL	GI40/7

**MEDIDAS (mm):**

COMPRIMENTO	168
D. INTERNO	
D. EXTERNO	58
ROSCA IN	
ROSCA OUT	
BICOS IN	8
BICOS OUT	

FIAT

**FCBR20S**

**OEM:**  
156713  
7700680162

**EQUIVALÊNCIAS:**

MANN	WK830
MAHLE	KL2
FRAM	G3829
WEGA	FC11670
TECFIL	GI01/1

**MEDIDAS (mm):**

COMPRIMENTO	159
D. INTERNO	
D. EXTERNO	80
ROSCA IN	
ROSCA OUT	
BICOS IN	8
BICOS OUT	

CHEVROLET / FORD / VW

**FCBR21S**

**OEM:**  
1J0201511A

**EQUIVALÊNCIAS:**

MANN	WK730/1
MAHLE	KL79
FRAM	G5870
WEGA	FC11288
TECFIL	GI10

**MEDIDAS (mm):**

COMPRIMENTO	170
D. INTERNO	
D. EXTERNO	75
ROSCA IN	
ROSCA OUT	
BICOS IN	8
BICOS OUT	

VW

**FCBR22S**

**OEM:**  
5Z0201511A

**EQUIVALÊNCIAS:**

MANN	WK730/4
MAHLE	KL635
FRAM	G9892F
WEGA	FC11696
TECFIL	GI12/7

**MEDIDAS (mm):**

COMPRIMENTO	180
D. INTERNO	
D. EXTERNO	75
ROSCA IN	
ROSCA OUT	
BICOS IN	9,5
BICOS OUT	

HONDA / MITSUBISHI / VW

**FCBR23S**

**OEM:**  
5S659155AA

**EQUIVALÊNCIAS:**

MANN	WK612/7
MAHLE	KL420
FRAM	G9291
WEGA	FC11695
TECFIL	GI60/7

**MEDIDAS (mm):**

COMPRIMENTO	192
D. INTERNO	
D. EXTERNO	55
ROSCA IN	
ROSCA OUT	
BICOS IN	7,89
BICOS OUT	

FORD

**FCBR24S**

**OEM:**  
3C119176BB  
4669224

**EQUIVALÊNCIAS:**

MANN	WK8154
MAHLE	
FRAM	PS10156
WEGA	FCD0185
TECFIL	

**MEDIDAS (mm):**

COMPRIMENTO	189
D. INTERNO	19
D. EXTERNO	80
ROSCA IN	
ROSCA OUT	
BICOS IN	
BICOS OUT	

FORD

**FCBR25S**

**OEM:**  
R26A50 (RACOR)  
3820927005

**EQUIVALÊNCIAS:**

MANN	WK940/24
MAHLE	KC119
FRAM	PS6643
WEGA	FCD3026
TECFIL	PSD530/1

**MEDIDAS (mm):**

COMPRIMENTO	120
D. INTERNO	
D. EXTERNO	95
ROSCA IN	1"x14
ROSCA OUT	
BICOS IN	
BICOS OUT	

FIAT

**FCBR26S**

**OEM:**  
503120784  
1908547

**EQUIVALÊNCIAS:**

MANN	WK950/6
MAHLE	KC186
FRAM	P5614
WEGA	FCD2057
TECFIL	PSC494

**MEDIDAS (mm):**

COMPRIMENTO	175
D. INTERNO	
D. EXTERNO	93
ROSCA IN	M14x1,5
ROSCA OUT	
BICOS IN	
BICOS OUT	

IVECO



**IVECO**

**FCBR27S**



<b>OEM:</b>	
2992300 504018807	
<b>EQUIVALÊNCIAS:</b>	
MANN	WK854/1
MAHLE	KC182
FRAM	PS10178
WEGA	FCD2096
TECFIL	PSC455
<b>MEDIDAS (mm):</b>	
COMPRIMENTO	172
D. INTERNO	
D. EXTERNO	82
ROSCA IN	M16x15-6H
ROSCA OUT	M12x15-6H
BICOS IN	
BICOS OUT	

**CHEVROLET**

**FCBR28S**



<b>OEM:</b>	
190614 7711502907	
<b>EQUIVALÊNCIAS:</b>	
MANN	
MAHLE	KX24
FRAM	
WEGA	
TECFIL	PC2/255
<b>MEDIDAS (mm):</b>	
COMPRIMENTO	111
D. INTERNO	19
D. EXTERNO	88
ROSCA IN	
ROSCA OUT	
BICOS IN	
BICOS OUT	

**MB**

**FCBR29S**



<b>OEM:</b>	
6110920601 6110900852	
<b>EQUIVALÊNCIAS:</b>	
MANN	WK842/13
MAHLE	KL100/2
FRAM	
WEGA	FCD2158/1
TECFIL	PSC881
<b>MEDIDAS (mm):</b>	
COMPRIMENTO	119
D. INTERNO	
D. EXTERNO	91
ROSCA IN	
ROSCA OUT	
BICOS IN	
BICOS OUT	

**VW**

**FCBR30S**



<b>OEM:</b>	
2HO127401A	
<b>EQUIVALÊNCIAS:</b>	
MANN	
MAHLE	
FRAM	P10695
WEGA	FCD0919
TECFIL	
<b>MEDIDAS (mm):</b>	
COMPRIMENTO	156
D. INTERNO	
D. EXTERNO	55
ROSCA IN	
ROSCA OUT	
BICOS IN	IN:8
BICOS OUT	OUT:9,5

**HONDA**

**FCBR31S**



<b>OEM:</b>	
17048SN000 1748SNA000	
<b>EQUIVALÊNCIAS:</b>	
MANN	
MAHLE	
FRAM	
WEGA	JFC452
TECFIL	
<b>MEDIDAS (mm):</b>	
COMPRIMENTO	156
D. INTERNO	
D. EXTERNO	55
ROSCA IN	
ROSCA OUT	
BICOS IN	IN:8
BICOS OUT	OUT:9,5

**HYUNDAI / KIA**

**FCBR32S**



<b>OEM:</b>	
319112E000 31911-2E	
<b>EQUIVALÊNCIAS:</b>	
MANN	
MAHLE	
FRAM	
WEGA	JFCH18
TECFIL	
<b>MEDIDAS (mm):</b>	
COMPRIMENTO	144
D. INTERNO	
D. EXTERNO	137
ROSCA IN	
ROSCA OUT	
BICOS IN	
BICOS OUT	

**MITSUBISHI**

**FCBR33S**



<b>OEM:</b>	
MB129895 MB257662	
<b>EQUIVALÊNCIAS:</b>	
MANN	
MAHLE	
FRAM	
WEGA	JFC504
TECFIL	
<b>MEDIDAS (mm):</b>	
COMPRIMENTO	156
D. INTERNO	
D. EXTERNO	55
ROSCA IN	
ROSCA OUT	
BICOS IN	IN:8
BICOS OUT	OUT:9,5

**KIA**

**FCBR34S**



<b>OEM:</b>	
0K71E23570A	
<b>EQUIVALÊNCIAS:</b>	
MANN	WK815
MAHLE	KC132
FRAM	P5173
WEGA	JFC509
TECFIL	
<b>MEDIDAS (mm):</b>	
COMPRIMENTO	122
D. INTERNO	62
D. EXTERNO	82,5
ROSCA IN	M20x1,5
ROSCA OUT	
BICOS IN	
BICOS OUT	

**VOLVO CAMINHÕES**

**FCBR35S**



<b>OEM:</b>	
R120L10MAQII 2R0127177C	
<b>EQUIVALÊNCIAS:</b>	
MANN	WK10002
MAHLE	
FRAM	
WEGA	FCD30125
TECFIL	PSD980
<b>MEDIDAS (mm):</b>	
COMPRIMENTO	220
D. INTERNO	90
D. EXTERNO	112
ROSCA IN	
ROSCA OUT	
BICOS IN	
BICOS OUT	

**IVECO**

**FCBR37S**



<b>OEM:</b>	
2992662	
<b>EQUIVALÊNCIAS:</b>	
MANN	WK950/19
MAHLE	KC214
FRAM	
WEGA	FCD2099
TECFIL	PSC493
<b>MEDIDAS (mm):</b>	
COMPRIMENTO	196
D. INTERNO	62
D. EXTERNO	96
ROSCA IN	
ROSCA OUT	
BICOS IN	
BICOS OUT	

**FCBR38S**

**MITSUBISHI**



<b>OEM:</b>	
CD130103	
130062	
<b>EQUIVALÊNCIAS:</b>	
MANN	
MAHLE	
FRAM	
WEGA	JFC503
TECFIL	
<b>MEDIDAS (mm):</b>	
COMPRIMENTO	122
D. INTERNO	
D. EXTERNO	93
ROSCA IN	3/4"X16UNF-2B
ROSCA OUT	
BICOS IN	
BICOS OUT	

**FCBR39S**

**CHEVROLET**



<b>OEM:</b>	
94771044	
94757663	
<b>EQUIVALÊNCIAS:</b>	
MANN	
MAHLE	
FRAM	
WEGA	FCD0777
TECFIL	
<b>MEDIDAS (mm):</b>	
COMPRIMENTO	107,7
D. INTERNO	10,6
D. EXTERNO	76,8/66
ROSCA IN	
ROSCA OUT	
BICOS IN	
BICOS OUT	

**FCBR40S**

**FORD**



<b>OEM:</b>	
AB3J9176AC	
<b>EQUIVALÊNCIAS:</b>	
MANN	
MAHLE	
FRAM	
WEGA	
TECFIL	
<b>MEDIDAS (mm):</b>	
COMPRIMENTO	76
D. INTERNO	9
D. EXTERNO	84
ROSCA IN	
ROSCA OUT	
BICOS IN	
BICOS OUT	

**FCBR41S**

**FORD / TROLLER**



<b>OEM:</b>	
905411510037	
<b>EQUIVALÊNCIAS:</b>	
MANN	
MAHLE	KX212
FRAM	
WEGA	FCD0775
TECFIL	
<b>MEDIDAS (mm):</b>	
COMPRIMENTO	107,6
D. INTERNO	14,64
D. EXTERNO	71
ROSCA IN	
ROSCA OUT	
BICOS IN	
BICOS OUT	

**FCBR42S**

**HYUNDAI / KIA**



<b>OEM:</b>	
319224H900	
319704E100	
<b>EQUIVALÊNCIAS:</b>	
MANN	
MAHLE	
FRAM	
WEGA	
TECFIL	
<b>MEDIDAS (mm):</b>	
COMPRIMENTO	
D. INTERNO	
D. EXTERNO	
ROSCA IN	
ROSCA OUT	
BICOS IN	
BICOS OUT	

**FCBR43S**

**TOYOTA**



<b>OEM:</b>	
233000Y010	
<b>EQUIVALÊNCIAS:</b>	
MANN	
MAHLE	KL706
FRAM	
WEGA	
TECFIL	
<b>MEDIDAS (mm):</b>	
COMPRIMENTO	81,6
D. INTERNO	
D. EXTERNO	40,9/63,5
ROSCA IN	
ROSCA OUT	
BICOS IN	7
BICOS OUT	

**FCBR44S**

**IVECO**



<b>OEM:</b>	
504170771	
<b>EQUIVALÊNCIAS:</b>	
MANN	PU9002X
MAHLE	KX340D
FRAM	C10635
WEGA	
TECFIL	
<b>MEDIDAS (mm):</b>	
COMPRIMENTO	150
D. INTERNO	35/15
D. EXTERNO	82
ROSCA IN	
ROSCA OUT	
BICOS IN	
BICOS OUT	

**FCBR45S**

**MB**



<b>OEM:</b>	
A6510901552	
<b>EQUIVALÊNCIAS:</b>	
MANN	WK820/8
MAHLE	
FRAM	
WEGA	
TECFIL	
<b>MEDIDAS (mm):</b>	
COMPRIMENTO	99,5
D. INTERNO	
D. EXTERNO	86,5
ROSCA IN	
ROSCA OUT	
BICOS IN	IN:11
BICOS OUT	OUT:9

**FCBR46S**

**TOYOTA**



<b>OEM:</b>	
2330075140	
<b>EQUIVALÊNCIAS:</b>	
MANN	
MAHLE	
FRAM	
WEGA	JFC237
TECFIL	
<b>MEDIDAS (mm):</b>	
COMPRIMENTO	152
D. INTERNO	
D. EXTERNO	62
ROSCA IN	
ROSCA OUT	
BICOS IN	8
BICOS OUT	

**FCBR47S**

**FORD**



<b>OEM:</b>	
CC119176BA	
<b>EQUIVALÊNCIAS:</b>	
MANN	
MAHLE	
FRAM	
WEGA	
TECFIL	
<b>MEDIDAS (mm):</b>	
COMPRIMENTO	293,8
D. INTERNO	31,75
D. EXTERNO	118/93
ROSCA IN	
ROSCA OUT	
BICOS IN	7,9
BICOS OUT	



**IVECO**

**FCBR48S**



OEM:	
5801354114 500054702	
EQUIVALÊNCIAS:	
MANN	
MAHLE	
FRAM	
WEGA	
TECFIL	
MEDIDAS (mm):	
COMPRIMENTO	165,8
D. INTERNO	27,0 / 48,90
D. EXTERNO	67,3
ROSCA IN	
ROSCA OUT	
BICOS IN	
BICOS OUT	

**SSANGYONG**

**FCBR49S**



OEM:	
2240008200	
EQUIVALÊNCIAS:	
MANN	
MAHLE	
FRAM	
WEGA	
TECFIL	
MEDIDAS (mm):	
COMPRIMENTO	133
D. INTERNO	
D. EXTERNO	75
ROSCA IN	M14X1,5
ROSCA OUT	
BICOS IN	
BICOS OUT	

**FORD**

**FCBR50S**



OEM:	
RFG87	
EQUIVALÊNCIAS:	
MANN	
MAHLE	KL465
FRAM	G9412
WEGA	FCI1697
TECFIL	
MEDIDAS (mm):	
COMPRIMENTO	179
D. INTERNO	
D. EXTERNO	55
ROSCA IN	
ROSCA OUT	
BICOS IN	8
BICOS OUT	

**KIA**

**FCBR51S**



OEM:	
319112K701	
EQUIVALÊNCIAS:	
MANN	
MAHLE	
FRAM	
WEGA	
TECFIL	
MEDIDAS (mm):	
COMPRIMENTO	196,8
D. INTERNO	
D. EXTERNO	55
ROSCA IN	
ROSCA OUT	
BICOS IN	
BICOS OUT	

**LAND ROVER**

**FCBR52S**



OEM:	
LR009705 WJ1500020	
EQUIVALÊNCIAS:	
MANN	
MAHLE	
FRAM	
WEGA	FCD2167
TECFIL	
MEDIDAS (mm):	
COMPRIMENTO	92
D. INTERNO	
D. EXTERNO	107
ROSCA IN	M10X1,5
ROSCA OUT	
BICOS IN	
BICOS OUT	

**HYUNDAI**

**FCH02S**



OEM:	
319113A000 7700820375	
EQUIVALÊNCIAS:	
MANN	WK68
MAHLE	KL146
FRAM	G5561
WEGA	FCI1907
TECFIL	
MEDIDAS (mm):	
COMPRIMENTO	128,3
D. INTERNO	
D. EXTERNO	65
ROSCA IN	
ROSCA OUT	
BICOS IN	IN:8
BICOS OUT	OUT:8

**HYUNDAI / KIA**

**FCH03S**



OEM:	
319222B900 319222R900	
EQUIVALÊNCIAS:	
MANN	WK824/3
MAHLE	KC101/1
FRAM	PS10667
WEGA	JFCK05/4
TECFIL	
MEDIDAS (mm):	
COMPRIMENTO	144
D. INTERNO	70
D. EXTERNO	80
ROSCA IN	IN:M16X1,5
ROSCA OUT	OUT:M10x1,5
BICOS IN	
BICOS OUT	

**KIA**

**FCH05S**



OEM:	
3192217400 3192226910	
EQUIVALÊNCIAS:	
MANN	WK818/1
MAHLE	KC101
FRAM	PS9841
WEGA	JFCK05/2
TECFIL	
MEDIDAS (mm):	
COMPRIMENTO	144
D. INTERNO	
D. EXTERNO	85
ROSCA IN	M16X1,5
ROSCA OUT	
BICOS IN	
BICOS OUT	

**HYUNDAI**

**FCH06S**



OEM:	
3111217000	
EQUIVALÊNCIAS:	
MANN	
MAHLE	
FRAM	
WEGA	JFCH06
TECFIL	
MEDIDAS (mm):	
COMPRIMENTO	142
D. INTERNO	
D. EXTERNO	82
ROSCA IN	
ROSCA OUT	
BICOS IN	IN:13
BICOS OUT	OUT:12

**HYUNDAI**

**FCH07S**



OEM:	
3111226000 3111226100	
EQUIVALÊNCIAS:	
MANN	
MAHLE	
FRAM	
WEGA	JFCH07
TECFIL	
MEDIDAS (mm):	
COMPRIMENTO	142
D. INTERNO	
D. EXTERNO	82
ROSCA IN	
ROSCA OUT	
BICOS IN	IN:13
BICOS OUT	OUT:12

**FCH11S**

HYUNDAI



OEM:  
319222E900  
319223A850

EQUIVALÊNCIAS:

MANN	WK824/1
MAHLE	KC226
FRAM	
WEGA	JFCH09
TECFIL	

MEDIDAS (mm):

COMPRIMENTO	141
D. INTERNO	70,5
D. EXTERNO	86
ROSCA IN	IN:M16X1,5
ROSCA OUT	OUT:M12x1,25
BICOS IN	
BICOS OUT	

**FCH13S**

HYUNDAI / KIA



OEM:  
3191138204

EQUIVALÊNCIAS:

MANN	
MAHLE	
FRAM	
WEGA	JFCH13
TECFIL	

MEDIDAS (mm):

COMPRIMENTO	152
D. INTERNO	
D. EXTERNO	81
ROSCA IN	
ROSCA OUT	
BICOS IN	IN:8
BICOS OUT	OUT:12

**FCH17S**

HYUNDAI / KIA



OEM:  
311123R000

EQUIVALÊNCIAS:

MANN	
MAHLE	
FRAM	
WEGA	JFCH26
TECFIL	

MEDIDAS (mm):

COMPRIMENTO	113
D. INTERNO	
D. EXTERNO	70
ROSCA IN	
ROSCA OUT	
BICOS IN	
BICOS OUT	

**FCK01S**

KIA



OEM:  
0K05423570  
OK05423570

EQUIVALÊNCIAS:

MANN	WK822/4
MAHLE	
FRAM	
WEGA	JFCK01
TECFIL	

MEDIDAS (mm):

COMPRIMENTO	102
D. INTERNO	62,5
D. EXTERNO	83
ROSCA IN	IN:M20X1,5
ROSCA OUT	OUT:M22x1,5
BICOS IN	
BICOS OUT	

**FCK03S**

KIA



OEM:  
OK71E23570  
OK55123570

EQUIVALÊNCIAS:

MANN	WK920/3
MAHLE	KC82
FRAM	PS8669
WEGA	JFC509/2
TECFIL	PSC996

MEDIDAS (mm):

COMPRIMENTO	149
D. INTERNO	62
D. EXTERNO	83
ROSCA IN	IN:M20X1,5
ROSCA OUT	OUT:M20x1,5
BICOS IN	
BICOS OUT	

**FCK04S**

KIA



OEM:  
OK08A20490B  
OK08A20490A

EQUIVALÊNCIAS:

MANN	
MAHLE	
FRAM	G8532
WEGA	JFCK04
TECFIL	

MEDIDAS (mm):

COMPRIMENTO	142
D. INTERNO	
D. EXTERNO	72
ROSCA IN	
ROSCA OUT	
BICOS IN	IN:8
BICOS OUT	OUT:8

**FCK05S**

KIA



OEM:  
OK2AA20490  
OK2A1204904

EQUIVALÊNCIAS:

MANN	
MAHLE	KL487
FRAM	G8534
WEGA	JFCK05
TECFIL	

MEDIDAS (mm):

COMPRIMENTO	165
D. INTERNO	
D. EXTERNO	72
ROSCA IN	
ROSCA OUT	
BICOS IN	IN:8
BICOS OUT	OUT:8

**FCK09S**

HYUNDAI / KIA



OEM:  
OK52A13480  
253409110117

EQUIVALÊNCIAS:

MANN	WK829/3
MAHLE	KL446
FRAM	PS9451
WEGA	FCD2063/1
TECFIL	

MEDIDAS (mm):

COMPRIMENTO	189
D. INTERNO	
D. EXTERNO	87,7
ROSCA IN	6,5
ROSCA OUT	
BICOS IN	IN:10
BICOS OUT	OUT:10

**FCK16S**

KIA



OEM:  
313003E200  
OK55212603A

EQUIVALÊNCIAS:

MANN	WK854/1
MAHLE	KC179
FRAM	PR3941
WEGA	JFCK05/1
TECFIL	

MEDIDAS (mm):

COMPRIMENTO	169
D. INTERNO	70
D. EXTERNO	86,5
ROSCA IN	IN:M16X1,5
ROSCA OUT	OUT:M10x1,5
BICOS IN	
BICOS OUT	

**FCK17S**

KIA



OEM:  
3111207000

EQUIVALÊNCIAS:

MANN	
MAHLE	
FRAM	
WEGA	JFCK09
TECFIL	

MEDIDAS (mm):

COMPRIMENTO	131
D. INTERNO	
D. EXTERNO	113
ROSCA IN	
ROSCA OUT	
BICOS IN	IN:12
BICOS OUT	OUT:16



**FCK18S**

CITROËN / MAHINDRA / PEUGEOT



OEM:  
0305DC0161N  
0K2KK13483

EQUIVALÊNCIAS:

MANN	WK854/6
MAHLE	KC140
FRAM	PS9420
WEGA	FCD2076
TECFIL	

MEDIDAS (mm):

COMPRIMENTO	143
D. INTERNO	68,4
D. EXTERNO	86
ROSCA IN	IN:M16X1,5
ROSCA OUT	OUT:10
BICOS IN	
BICOS OUT	

**FCK20S**

KIA



OEM:  
3191138201

EQUIVALÊNCIAS:

MANN	
MAHLE	
FRAM	
WEGA	JFCK11
TECFIL	

MEDIDAS (mm):

COMPRIMENTO	162
D. INTERNO	
D. EXTERNO	82
ROSCA IN	
ROSCA OUT	
BICOS IN	IN:7,4
BICOS OUT	OUT:11,6

**FCK23S**

HYUNDAI / KIA



OEM:  
319102H000

EQUIVALÊNCIAS:

MANN	
MAHLE	
FRAM	
WEGA	JFCH05
TECFIL	

MEDIDAS (mm):

COMPRIMENTO	130
D. INTERNO	
D. EXTERNO	88
ROSCA IN	
ROSCA OUT	
BICOS IN	IN:9
BICOS OUT	OUT:13

**FCK24S**

KIA



OEM:  
0K52Y20490

EQUIVALÊNCIAS:

MANN	WK614/48
MAHLE	
FRAM	
WEGA	
TECFIL	

MEDIDAS (mm):

COMPRIMENTO	120,4
D. INTERNO	
D. EXTERNO	82
ROSCA IN	
ROSCA OUT	
BICOS IN	
BICOS OUT	

**FCK25S**

HYUNDAI / KIA



OEM:  
319112E000

EQUIVALÊNCIAS:

MANN	
MAHLE	
FRAM	
WEGA	JFCH18
TECFIL	

MEDIDAS (mm):

COMPRIMENTO	144
D. INTERNO	
D. EXTERNO	137
ROSCA IN	
ROSCA OUT	
BICOS IN	
BICOS OUT	

**FCK26S**

KIA



OEM:  
319112G000  
3191126000

EQUIVALÊNCIAS:

MANN	
MAHLE	
FRAM	
WEGA	JFCK11
TECFIL	

MEDIDAS (mm):

COMPRIMENTO	134
D. INTERNO	
D. EXTERNO	88
ROSCA IN	
ROSCA OUT	
BICOS IN	
BICOS OUT	

**FCK27S**

KIA



OEM:  
319113E200

EQUIVALÊNCIAS:

MANN	
MAHLE	
FRAM	
WEGA	JFCK06
TECFIL	

MEDIDAS (mm):

COMPRIMENTO	136
D. INTERNO	
D. EXTERNO	81
ROSCA IN	
ROSCA OUT	
BICOS IN	
BICOS OUT	

**FCK28S**

HYUNDAI



OEM:  
311123Q500

EQUIVALÊNCIAS:

MANN	
MAHLE	
FRAM	
WEGA	JFCH25
TECFIL	

MEDIDAS (mm):

COMPRIMENTO	88
D. INTERNO	
D. EXTERNO	95
ROSCA IN	
ROSCA OUT	
BICOS IN	
BICOS OUT	

**FCK29S**

HYUNDAI



OEM:  
311122P000

EQUIVALÊNCIAS:

MANN	
MAHLE	
FRAM	
WEGA	JFCH24
TECFIL	

MEDIDAS (mm):

COMPRIMENTO	88
D. INTERNO	
D. EXTERNO	95
ROSCA IN	
ROSCA OUT	
BICOS IN	
BICOS OUT	

**FCL02S**

FORD / NISSAN / TROLLER



OEM:  
WJN10046  
905400150015

EQUIVALÊNCIAS:

MANN	WK842/3
MAHLE	KL41
FRAM	P4836
WEGA	FCD2066
TECFIL	PSC498

MEDIDAS (mm):

COMPRIMENTO	167
D. INTERNO	
D. EXTERNO	90,5
ROSCA IN	
ROSCA OUT	
BICOS IN	IN:8
BICOS OUT	OUT:8

**FCL05S**

LAND ROVER



OEM:	
WJN500025 LR007311	
EQUIVALÊNCIAS:	
MANN	WK829/4
MAHLE	KL506
FRAM	P10614
WEGA	FCD2164
TECFIL	
MEDIDAS (mm):	
COMPRIMENTO	187
D. INTERNO	
D. EXTERNO	86,4
ROSCA IN	
ROSCA OUT	
BICOS IN	IN:10
BICOS OUT	OUT:10

**FCL06S**

LAND ROVER



OEM:	
WFL000070 WFL4070	
EQUIVALÊNCIAS:	
MANN	WK841/1
MAHLE	KL160/1
FRAM	P9554
WEGA	FCD2080
TECFIL	
MEDIDAS (mm):	
COMPRIMENTO	177
D. INTERNO	
D. EXTERNO	83,3
ROSCA IN	
ROSCA OUT	
BICOS IN	IN:8
BICOS OUT	OUT:8

**FCL07S**

LAND ROVER



OEM:	
STC2827	
EQUIVALÊNCIAS:	
MANN	WK845/4
MAHLE	KC47
FRAM	P5654
WEGA	
TECFIL	
MEDIDAS (mm):	
COMPRIMENTO	183,5
D. INTERNO	70
D. EXTERNO	85
ROSCA IN	M16X1,5
ROSCA OUT	
BICOS IN	
BICOS OUT	

**FCL08S**

LAND ROVER / VW



OEM:	
AEU2147	
EQUIVALÊNCIAS:	
MANN	WK736
MAHLE	
FRAM	
WEGA	
TECFIL	
MEDIDAS (mm):	
COMPRIMENTO	155
D. INTERNO	69
D. EXTERNO	85
ROSCA IN	M16X1,5
ROSCA OUT	
BICOS IN	
BICOS OUT	

**FCL09S**

CHEVROLET / FORD / LAND ROVER



OEM:	
ESR4686	
EQUIVALÊNCIAS:	
MANN	WK730/2X
MAHLE	
FRAM	P8845
WEGA	FCD1119
TECFIL	
MEDIDAS (mm):	
COMPRIMENTO	139
D. INTERNO	70
D. EXTERNO	86,3
ROSCA IN	IN:M16X1,5
ROSCA OUT	OUT:8,0
BICOS IN	
BICOS OUT	

**FCM00S**

SMART



OEM:	
C0003414V0020000 1117100	
EQUIVALÊNCIAS:	
MANN	
MAHLE	
FRAM	
WEGA	FCI1101C
TECFIL	
MEDIDAS (mm):	
COMPRIMENTO	135,5
D. INTERNO	
D. EXTERNO	59,5
ROSCA IN	
ROSCA OUT	
BICOS IN	IN:8
BICOS OUT	OUT:8

**FCM01S**

SMART



OEM:	
C0002591V003 0002591V004	
EQUIVALÊNCIAS:	
MANN	
MAHLE	
FRAM	
WEGA	
TECFIL	
MEDIDAS (mm):	
COMPRIMENTO	137
D. INTERNO	
D. EXTERNO	61,5
ROSCA IN	
ROSCA OUT	
BICOS IN	IN:8
BICOS OUT	OUT:8

**FCS01S**

SSANGYONG



OEM:	
6650921001 278909110121	
EQUIVALÊNCIAS:	
MANN	WK829/6
MAHLE	KL505
FRAM	PS10672
WEGA	JFCS01
TECFIL	
MEDIDAS (mm):	
COMPRIMENTO	176
D. INTERNO	
D. EXTERNO	86,2
ROSCA IN	8,5
ROSCA OUT	
BICOS IN	IN:10
BICOS OUT	OUT:10

**FCS02S**

SSANGYONG



OEM:	
2240008000	
EQUIVALÊNCIAS:	
MANN	
MAHLE	
FRAM	
WEGA	JFCS02
TECFIL	
MEDIDAS (mm):	
COMPRIMENTO	104
D. INTERNO	
D. EXTERNO	70
ROSCA IN	IN:M14X1,5
ROSCA OUT	OUT:M14x1,5
BICOS IN	
BICOS OUT	

**FCW00S**

SUZUKI



OEM:	
15410A78B00	
EQUIVALÊNCIAS:	
MANN	WK52
MAHLE	
FRAM	G9307
WEGA	JFCW00
TECFIL	
MEDIDAS (mm):	
COMPRIMENTO	76
D. INTERNO	
D. EXTERNO	58
ROSCA IN	
ROSCA OUT	
BICOS IN	IN:7
BICOS OUT	OUT:7

**FCW01S**

CHANA / CHEVROLET / DAEWOO



<b>OEM:</b>	
25161062	
96335719	
<b>EQUIVALÊNCIAS:</b>	
MANN	WK58
MAHLE	KL83
FRAM	G5540
WEGA	FCI1110S
TECFIL	GI04/1
<b>MEDIDAS (mm):</b>	
COMPRIMENTO	160
D. INTERNO	
D. EXTERNO	59,3
ROSCA IN	
ROSCA OUT	
BICOS IN	IN:8
BICOS OUT	OUT:8

**FCECO001**

MB CAMINHÕES



<b>OEM:</b>	
5410900051	
5410900151	
<b>EQUIVALÊNCIAS:</b>	
MANN	PU999/1X
MAHLE	KX80D
FRAM	C5932
WEGA	FCD0769
TECFIL	PEC3021
<b>MEDIDAS (mm):</b>	
COMPRIMENTO	203
D. INTERNO	47/11
D. EXTERNO	94
ROSCA IN	
ROSCA OUT	
BICOS IN	
BICOS OUT	

**FCECO002**

MB



<b>OEM:</b>	
6110920005	
6110900652	
<b>EQUIVALÊNCIAS:</b>	
MANN	PU839X
MAHLE	KX70D
FRAM	CH8981
WEGA	FCD0729
TECFIL	
<b>MEDIDAS (mm):</b>	
COMPRIMENTO	92
D. INTERNO	18
D. EXTERNO	78,6
ROSCA IN	
ROSCA OUT	
BICOS IN	
BICOS OUT	

**FCECO003**

MB CAMINHÕES



<b>OEM:</b>	
9060920105	
9060900051	
<b>EQUIVALÊNCIAS:</b>	
MANN	PU1046/1X
MAHLE	KX67/2D
FRAM	C8826
WEGA	FCD0768
TECFIL	PEC3022
<b>MEDIDAS (mm):</b>	
COMPRIMENTO	102
D. INTERNO	28/6
D. EXTERNO	92
ROSCA IN	
ROSCA OUT	
BICOS IN	
BICOS OUT	

**FCECO011**

CHEVROLET / SUZUKI



<b>OEM:</b>	
1541267G00	
1541267G00000	
<b>EQUIVALÊNCIAS:</b>	
MANN	PU922X
MAHLE	KX87D
FRAM	CG8953
WEGA	FCD0767
TECFIL	
<b>MEDIDAS (mm):</b>	
COMPRIMENTO	80
D. INTERNO	30,5/27
D. EXTERNO	81,5
ROSCA IN	
ROSCA OUT	
BICOS IN	
BICOS OUT	

**FCECO015**

RENAULT



<b>OEM:</b>	
7701044913	
1541567JAO	
<b>EQUIVALÊNCIAS:</b>	
MANN	P733/1X
MAHLE	KX206D
FRAM	C8820
WEGA	FCD0816/1
TECFIL	
<b>MEDIDAS (mm):</b>	
COMPRIMENTO	91
D. INTERNO	20
D. EXTERNO	69
ROSCA IN	
ROSCA OUT	
BICOS IN	
BICOS OUT	

**FCECO016**

CITROËN / FIAT / PEUGEOT



<b>OEM:</b>	
1541184E60	
77362340	
<b>EQUIVALÊNCIAS:</b>	
MANN	PU723X
MAHLE	KX208D
FRAM	C10705
WEGA	FCD0771
TECFIL	PEC3023
<b>MEDIDAS (mm):</b>	
COMPRIMENTO	102
D. INTERNO	25
D. EXTERNO	67
ROSCA IN	
ROSCA OUT	
BICOS IN	
BICOS OUT	

**FCECO017**

RENAULT



<b>OEM:</b>	
7701208613	
1640500QAC	
<b>EQUIVALÊNCIAS:</b>	
MANN	P718/1X
MAHLE	KX218D
FRAM	C9927
WEGA	FCD0816/2
TECFIL	PC947
<b>MEDIDAS (mm):</b>	
COMPRIMENTO	86
D. INTERNO	20
D. EXTERNO	71
ROSCA IN	
ROSCA OUT	
BICOS IN	
BICOS OUT	

**FCECO080**

JEEP



<b>OEM:</b>	
4726067AA	
<b>EQUIVALÊNCIAS:</b>	
MANN	
MAHLE	
FRAM	
WEGA	
TECFIL	
<b>MEDIDAS (mm):</b>	
COMPRIMENTO	73
D. INTERNO	13
D. EXTERNO	67
ROSCA IN	
ROSCA OUT	
BICOS IN	
BICOS OUT	

**FCECO081**

SSANGYOUNG



<b>OEM:</b>	
2247634000	
<b>EQUIVALÊNCIAS:</b>	
MANN	
MAHLE	
FRAM	
WEGA	FCD0783
TECFIL	
<b>MEDIDAS (mm):</b>	
COMPRIMENTO	99
D. INTERNO	9,5
D. EXTERNO	84,4
ROSCA IN	
ROSCA OUT	
BICOS IN	
BICOS OUT	



**FAACD1**

**CADILLAC**



OEM:	
25740404	
EQUIVALÊNCIAS:	
MANN	MC1057
MAHLE	
FRAM	
WEGA	AKX3533
TECFIL	
MEDIDAS (mm):	
COMPRIMENTO	264
LARGURA	234
ALTURA	24
D. INTERNO	
D. EXTERNO	
ROSCA	
BICOS	

**FAACH0**

**DODGE**



OEM:	
82205905	
EQUIVALÊNCIAS:	
MANN	CUK3142
MAHLE	LAK159
FRAM	CF9597
WEGA	AKX1900
TECFIL	
MEDIDAS (mm):	
COMPRIMENTO	306,5
LARGURA	233
ALTURA	22
D. INTERNO	
D. EXTERNO	
ROSCA	
BICOS	

**FAACH1**

**CHRYSLER**



OEM:	
05058040AA	
EQUIVALÊNCIAS:	
MANN	CU2329
MAHLE	LA180
FRAM	
WEGA	AKX1911
TECFIL	
MEDIDAS (mm):	
COMPRIMENTO	225,1
LARGURA	115,2
ALTURA	30
D. INTERNO	
D. EXTERNO	
ROSCA	
BICOS	

**FAACH3**

**CHRYSLER / DODGE / FIAT / JEEP**



OEM:	
05058693AA	
EQUIVALÊNCIAS:	
MANN	CU2227
MAHLE	LA569
FRAM	CF10729
WEGA	AKX2102
TECFIL	
MEDIDAS (mm):	
COMPRIMENTO	216
LARGURA	195
ALTURA	25
D. INTERNO	
D. EXTERNO	
ROSCA	
BICOS	

**FAACH4**

**CHRYSLER / DODGE**



OEM:	
04596501AB	
EQUIVALÊNCIAS:	
MANN	CU3137
MAHLE	LA247
FRAM	CF10364
WEGA	AKX1901
TECFIL	
MEDIDAS (mm):	
COMPRIMENTO	309
LARGURA	212
ALTURA	30
D. INTERNO	
D. EXTERNO	
ROSCA	
BICOS	

**FAADDW5**

**SSANGYONG**



OEM:	
6923005400	
EQUIVALÊNCIAS:	
MANN	
MAHLE	
FRAM	
WEGA	
TECFIL	
MEDIDAS (mm):	
COMPRIMENTO	200
LARGURA	86/94
ALTURA	12/20
D. INTERNO	
D. EXTERNO	
ROSCA	
BICOS	

**FAADDW7**

**SSANGYONG**



OEM:	
6812008130	
EQUIVALÊNCIAS:	
MANN	
MAHLE	LA391/S
FRAM	
WEGA	AKX3584
TECFIL	
MEDIDAS (mm):	
COMPRIMENTO	274,6
LARGURA	103
ALTURA	20
D. INTERNO	
D. EXTERNO	
ROSCA	
BICOS	

**FAADDW8**

**SSANGYONG**



OEM:	
6923005410	
EQUIVALÊNCIAS:	
MANN	
MAHLE	
FRAM	
WEGA	
TECFIL	
MEDIDAS (mm):	
COMPRIMENTO	221
LARGURA	88,2
ALTURA	12,2
D. INTERNO	
D. EXTERNO	
ROSCA	
BICOS	

**FAADDW12**

**CHEVROLET**



OEM:	
96440878	
EQUIVALÊNCIAS:	
MANN	CU2622
MAHLE	LA421
FRAM	
WEGA	AKX3535
TECFIL	ACP125
MEDIDAS (mm):	
COMPRIMENTO	273
LARGURA	196
ALTURA	27
D. INTERNO	
D. EXTERNO	
ROSCA	
BICOS	

**FAADDW15**

**CADILLAC / CHEVROLET**



OEM:	
13271191	
EQUIVALÊNCIAS:	
MANN	CU2442
MAHLE	LAK472
FRAM	CF10775
WEGA	AKX35723
TECFIL	ACP126
MEDIDAS (mm):	
COMPRIMENTO	240
LARGURA	206
ALTURA	35
D. INTERNO	
D. EXTERNO	
ROSCA	
BICOS	

CHEVROLET	<b>FAADDW16</b>	
	OEM: 95947238	
	EQUIVALÊNCIAS:	
	MANN	CU20010
	MAHLE	
FRAM		
WEGA		
TECFIL		
MEDIDAS (mm):		
COMPRIMENTO	214	
LARGURA	200	
ALTURA	20	
D. INTERNO		
D. EXTERNO		
ROSCA		
BICOS		



CHERY	<b>FAADRO</b>	
	OEM: T118107910	
	EQUIVALÊNCIAS:	
	MANN	
	MAHLE	
FRAM	AKX1700	
WEGA		
TECFIL		
MEDIDAS (mm):		
COMPRIMENTO	200	
LARGURA	225/256	
ALTURA	21/45	
D. INTERNO		
D. EXTERNO		
ROSCA		
BICOS		



HONDA	<b>FAAH03</b>	
	OEM: 79370S1AG01	
	EQUIVALÊNCIAS:	
	MANN	CU2253
	MAHLE	LA82
FRAM	CF5865	
WEGA	AKX3599	
TECFIL	ACP700	
MEDIDAS (mm):		
COMPRIMENTO	296	
LARGURA	211	
ALTURA	25	
D. INTERNO		
D. EXTERNO		
ROSCA		
BICOS		



HONDA	<b>FAAH04</b>	
	OEM: 80292SCAE11	
	EQUIVALÊNCIAS:	
	MANN	CU23272
	MAHLE	LA122/S
FRAM	CF10108	
WEGA	AKX35181	
TECFIL	ACP703	
MEDIDAS (mm):		
COMPRIMENTO	224	
LARGURA	109	
ALTURA	29	
D. INTERNO		
D. EXTERNO		
ROSCA		
BICOS		



HONDA	<b>FAAH05</b>	
	OEM: 08R79SAA600B	
	EQUIVALÊNCIAS:	
	MANN	CU1835
	MAHLE	LA155
FRAM	CF10073	
WEGA	AKX1937	
TECFIL	ACP707	
MEDIDAS (mm):		
COMPRIMENTO	176,5	
LARGURA	185	
ALTURA	30	
D. INTERNO		
D. EXTERNO		
ROSCA		
BICOS		



HONDA	<b>FAAH07</b>	
	OEM: 80292SDCA01	
	EQUIVALÊNCIAS:	
	MANN	CU2358
	MAHLE	LA216
FRAM	CF10838	
WEGA	AKX1456	
TECFIL	ACP708	
MEDIDAS (mm):		
COMPRIMENTO	225,2	
LARGURA	235	
ALTURA	30	
D. INTERNO		
D. EXTERNO		
ROSCA		
BICOS		



HONDA	<b>FAAH011</b>	
	OEM: 80292SWWG01	
	EQUIVALÊNCIAS:	
	MANN	CU2358
	MAHLE	
FRAM		
WEGA	AKX1456	
TECFIL	ACP708	
MEDIDAS (mm):		
COMPRIMENTO	235	
LARGURA	225	
ALTURA	30	
D. INTERNO		
D. EXTERNO		
ROSCA		
BICOS		



HUMMER	<b>FAAHM00</b>	
	OEM: 88986533	
	EQUIVALÊNCIAS:	
	MANN	
	MAHLE	
FRAM		
WEGA	AKX2900	
TECFIL		
MEDIDAS (mm):		
COMPRIMENTO	268	
LARGURA	238	
ALTURA	26	
D. INTERNO		
D. EXTERNO		
ROSCA		
BICOS		



HYUNDAI	<b>FAAHY07</b>	
	OEM: 974064A900	
	EQUIVALÊNCIAS:	
	MANN	CU19002
	MAHLE	LA453
FRAM		
WEGA	AKX1991	
TECFIL		
MEDIDAS (mm):		
COMPRIMENTO	112,8/197,5	
LARGURA	132,5/182	
ALTURA	42,7	
D. INTERNO		
D. EXTERNO		
ROSCA		
BICOS		



HYUNDAI / KIA	<b>FAAHY11</b>	
	OEM: 971332E200	
	EQUIVALÊNCIAS:	
	MANN	CU2336
	MAHLE	LA301
FRAM	CF10210	
WEGA	AKX2001	
TECFIL	ACP971	
MEDIDAS (mm):		
COMPRIMENTO	225	
LARGURA	204	
ALTURA	17	
D. INTERNO		
D. EXTERNO		
ROSCA		
BICOS		



**FAAHY17**

HYUNDAI



OEM:	
97030H1742	
EQUIVALÊNCIAS:	
MANN	CU2441
MAHLE	LA349/S
FRAM	
WEGA	AKX1981
TECFIL	
MEDIDAS (mm):	
COMPRIMENTO	247
LARGURA	105
ALTURA	25
D. INTERNO	
D. EXTERNO	
ROSCA	
BICOS	

**FAAHY23**

HYUNDAI / KIA



OEM:	
971333K000	
EQUIVALÊNCIAS:	
MANN	CU2362
MAHLE	LA343
FRAM	CF10381
WEGA	AKX1990
TECFIL	ACP974
MEDIDAS (mm):	
COMPRIMENTO	250,5
LARGURA	218,5
ALTURA	29
D. INTERNO	
D. EXTERNO	
ROSCA	
BICOS	

**FAAHY29**

HYUNDAI



OEM:	
971332E250	
EQUIVALÊNCIAS:	
MANN	CU24004
MAHLE	LA301
FRAM	CF10150
WEGA	AKX1984
TECFIL	ACP972
MEDIDAS (mm):	
COMPRIMENTO	237
LARGURA	190
ALTURA	19
D. INTERNO	
D. EXTERNO	
ROSCA	
BICOS	

**FAAJE1**

JEEP



OEM:	
82208300	
EQUIVALÊNCIAS:	
MANN	CU4727
MAHLE	
FRAM	
WEGA	AKX2101
TECFIL	
MEDIDAS (mm):	
COMPRIMENTO	389/468,2
LARGURA	46/78
ALTURA	40
D. INTERNO	
D. EXTERNO	
ROSCA	
BICOS	

**FAAJE2**

DODGE / JEEP



OEM:	
68079487AA	
EQUIVALÊNCIAS:	
MANN	CU27008
MAHLE	
FRAM	CF11183
WEGA	AKX2105
TECFIL	
MEDIDAS (mm):	
COMPRIMENTO	263
LARGURA	243
ALTURA	30
D. INTERNO	
D. EXTERNO	
ROSCA	
BICOS	

**FAAKI00**

KIA



OEM:	
0K55361C14	
EQUIVALÊNCIAS:	
MANN	CU2640
MAHLE	
FRAM	
WEGA	AKX1996
TECFIL	
MEDIDAS (mm):	
COMPRIMENTO	260
LARGURA	223,6
ALTURA	21
D. INTERNO	
D. EXTERNO	
ROSCA	
BICOS	

**FAAKI06**

HYUNDAI / KIA



OEM:	
9761938100	
EQUIVALÊNCIAS:	
MANN	CU2647
MAHLE	
FRAM	
WEGA	AKX2011
TECFIL	
MEDIDAS (mm):	
COMPRIMENTO	261
LARGURA	193
ALTURA	38
D. INTERNO	
D. EXTERNO	
ROSCA	
BICOS	

**FAAKI08**

KIA



OEM:	
0K55661C14	
EQUIVALÊNCIAS:	
MANN	
MAHLE	
FRAM	
WEGA	
TECFIL	
MEDIDAS (mm):	
COMPRIMENTO	259
LARGURA	224,5
ALTURA	20,7
D. INTERNO	
D. EXTERNO	
ROSCA	
BICOS	

**FAAKI09**

KIA



OEM:	
9713307000	
EQUIVALÊNCIAS:	
MANN	CU1910
MAHLE	LA471
FRAM	CF10627
WEGA	AKX1988
TECFIL	
MEDIDAS (mm):	
COMPRIMENTO	183
LARGURA	181
ALTURA	12
D. INTERNO	
D. EXTERNO	
ROSCA	
BICOS	

**FAAKI10**

KIA



OEM:	
971332F000	
EQUIVALÊNCIAS:	
MANN	CU2434
MAHLE	LA298
FRAM	CF10248
WEGA	AKX1985
TECFIL	ACP977
MEDIDAS (mm):	
COMPRIMENTO	240
LARGURA	210
ALTURA	17
D. INTERNO	
D. EXTERNO	
ROSCA	
BICOS	



**FAAKI11**



**OEM:**  
976193D100

**EQUIVALÊNCIAS:**

MANN	CU2542/2
MAHLE	
FRAM	
WEGA	
TECFIL	

**MEDIDAS (mm):**

COMPRIMENTO	257,3
LARGURA	98,7
ALTURA	37,7
D. INTERNO	
D. EXTERNO	
ROSCA	
BICOS	

**FAAKI14**



**OEM:**  
971143B100

**EQUIVALÊNCIAS:**

MANN	
MAHLE	
FRAM	
WEGA	AKX1989
TECFIL	

**MEDIDAS (mm):**

COMPRIMENTO	262
LARGURA	238,5
ALTURA	40
D. INTERNO	
D. EXTERNO	
ROSCA	
BICOS	

**FAAKI17**



**OEM:**  
971332E900

**EQUIVALÊNCIAS:**

MANN	CU2214/2
MAHLE	LA444/S
FRAM	CF10210
WEGA	AKX1983
TECFIL	ACP975

**MEDIDAS (mm):**

COMPRIMENTO	218
LARGURA	107
ALTURA	17
D. INTERNO	
D. EXTERNO	
ROSCA	
BICOS	

**FAAKI18**



**OEM:**  
971331H000

**EQUIVALÊNCIAS:**

MANN	CU2631
MAHLE	
FRAM	CF10471
WEGA	AKX2004
TECFIL	ACP979

**MEDIDAS (mm):**

COMPRIMENTO	248
LARGURA	174
ALTURA	20
D. INTERNO	
D. EXTERNO	
ROSCA	
BICOS	

**FAAKI19**



**OEM:**  
971332K000

**EQUIVALÊNCIAS:**

MANN	CU19001
MAHLE	LA531
FRAM	CF10776
WEGA	AKX1987
TECFIL	ACP976

**MEDIDAS (mm):**

COMPRIMENTO	182
LARGURA	161
ALTURA	25
D. INTERNO	
D. EXTERNO	
ROSCA	
BICOS	

**FAALR1**



**OEM:**  
64318409044

**EQUIVALÊNCIAS:**

MANN	CUK5366
MAHLE	LAK62
FRAM	
WEGA	AKX1422
TECFIL	

**MEDIDAS (mm):**

COMPRIMENTO	531,1
LARGURA	248,3
ALTURA	30,5
D. INTERNO	
D. EXTERNO	
ROSCA	
BICOS	

**FAALR2**



**OEM:**  
JKR100280

**EQUIVALÊNCIAS:**

MANN	CU2423
MAHLE	LA360
FRAM	CF10087
WEGA	AKX1933
TECFIL	

**MEDIDAS (mm):**

COMPRIMENTO	243
LARGURA	199/219,8
ALTURA	32,5/74,5
D. INTERNO	
D. EXTERNO	
ROSCA	
BICOS	

**FAALR3**



**OEM:**  
BTR8037

**EQUIVALÊNCIAS:**

MANN	CU1009
MAHLE	LA288
FRAM	CF8719
WEGA	AKX1419
TECFIL	

**MEDIDAS (mm):**

COMPRIMENTO	217,2
LARGURA	197
ALTURA	24
D. INTERNO	
D. EXTERNO	
ROSCA	
BICOS	

**FAALR4**



**OEM:**  
JKR500020

**EQUIVALÊNCIAS:**

MANN	CUK2747
MAHLE	LAK280
FRAM	
WEGA	AKX1935
TECFIL	

**MEDIDAS (mm):**

COMPRIMENTO	263,5
LARGURA	165
ALTURA	30
D. INTERNO	
D. EXTERNO	
ROSCA	
BICOS	

**FAALR5**



**OEM:**  
LR000899

**EQUIVALÊNCIAS:**

MANN	CU2733
MAHLE	LA387
FRAM	CF10442
WEGA	AKX1938
TECFIL	

**MEDIDAS (mm):**

COMPRIMENTO	268
LARGURA	196
ALTURA	32
D. INTERNO	
D. EXTERNO	
ROSCA	
BICOS	

**FAAMI2**



**OEM:**  
MZ311917

**EQUIVALÊNCIAS:**

MANN	CU230002
MAHLE	LA296/S
FRAM	
WEGA	
TECFIL	

**MEDIDAS (mm):**

COMPRIMENTO	227
LARGURA	197/207
ALTURA	25/37
D. INTERNO	
D. EXTERNO	
ROSCA	
BICOS	

mitsubishi

**FAAMI4**



**OEM:**  
7803A028

**EQUIVALÊNCIAS:**

MANN	CUK2230
MAHLE	LAK589
FRAM	
WEGA	AKX1997/C
TECFIL	

**MEDIDAS (mm):**

COMPRIMENTO	215/240
LARGURA	217
ALTURA	30,5/55
D. INTERNO	
D. EXTERNO	
ROSCA	
BICOS	

mitsubishi

**FAAMI5**



**OEM:**  
MR398288

**EQUIVALÊNCIAS:**

MANN	CUK2231
MAHLE	LAK485
FRAM	
WEGA	AKX1995/C
TECFIL	

**MEDIDAS (mm):**

COMPRIMENTO	215
LARGURA	210
ALTURA	30
D. INTERNO	
D. EXTERNO	
ROSCA	
BICOS	

mitsubishi

**FAAMI7**



**OEM:**  
7803A004

**EQUIVALÊNCIAS:**

MANN	CU2141
MAHLE	LA424
FRAM	CF10431
WEGA	AKX1993
TECFIL	

**MEDIDAS (mm):**

COMPRIMENTO	215
LARGURA	201
ALTURA	30
D. INTERNO	
D. EXTERNO	
ROSCA	
BICOS	

mitsubishi

**FAAMI8**



**OEM:**  
MR315172

**EQUIVALÊNCIAS:**

MANN	CU2106/2
MAHLE	LA366/S
FRAM	
WEGA	AKX1992
TECFIL	ACP481

**MEDIDAS (mm):**

COMPRIMENTO	206
LARGURA	100
ALTURA	37
D. INTERNO	
D. EXTERNO	
ROSCA	
BICOS	

mitsubishi

**FAANS8**



**OEM:**  
B727A79925

**EQUIVALÊNCIAS:**

MANN	CU2252
MAHLE	LA371
FRAM	CF9882
WEGA	AKX1955
TECFIL	

**MEDIDAS (mm):**

COMPRIMENTO	219
LARGURA	198
ALTURA	29
D. INTERNO	
D. EXTERNO	
ROSCA	
BICOS	

INFINITY / NISSAN

**FAANS9**



**OEM:**  
27274EA000

**EQUIVALÊNCIAS:**

MANN	CU2623
MAHLE	LA289
FRAM	CF10553
WEGA	AKX1954
TECFIL	

**MEDIDAS (mm):**

COMPRIMENTO	262
LARGURA	100
ALTURA	24,5
D. INTERNO	
D. EXTERNO	
ROSCA	
BICOS	

NISSAN

**FAANS10**



**OEM:**  
27277EN000

**EQUIVALÊNCIAS:**

MANN	CU1936
MAHLE	LA396
FRAM	
WEGA	AKX1953
TECFIL	ACP727

**MEDIDAS (mm):**

COMPRIMENTO	265
LARGURA	192
ALTURA	20
D. INTERNO	
D. EXTERNO	
ROSCA	
BICOS	

NISSAN

**FAANS14**



**OEM:**  
B7277JN20A

**EQUIVALÊNCIAS:**

MANN	CU29001
MAHLE	
FRAM	
WEGA	
TECFIL	

**MEDIDAS (mm):**

COMPRIMENTO	270
LARGURA	280
ALTURA	20
D. INTERNO	
D. EXTERNO	
ROSCA	
BICOS	

NISSAN

**FAANS15**



**OEM:**  
272771HE0E

**EQUIVALÊNCIAS:**

MANN	CU23011
MAHLE	
FRAM	
WEGA	
TECFIL	

**MEDIDAS (mm):**

COMPRIMENTO	210
LARGURA	225
ALTURA	20
D. INTERNO	
D. EXTERNO	
ROSCA	
BICOS	

NISSAN

**FAANS17**

NISSAN



OEM:	
27274ED000	
EQUIVALÊNCIAS:	
MANN	CU22007
MAHLE	LA480
FRAM	CF10545
WEGA	AKX1956
TECFIL	
MEDIDAS (mm):	
COMPRIMENTO	218
LARGURA	180
ALTURA	36
D. INTERNO	
D. EXTERNO	
ROSCA	
BICOS	

**FAASB0**

SUBARU



OEM:	
72880FE000	
EQUIVALÊNCIAS:	
MANN	CU2145
MAHLE	
FRAM	
WEGA	AKX1986
TECFIL	
MEDIDAS (mm):	
COMPRIMENTO	211
LARGURA	185
ALTURA	31,2
D. INTERNO	
D. EXTERNO	
ROSCA	
BICOS	

**FAASB1**

SUBARU



OEM:	
72880AE000	
EQUIVALÊNCIAS:	
MANN	
MAHLE	
FRAM	
WEGA	
TECFIL	
MEDIDAS (mm):	
COMPRIMENTO	201
LARGURA	202
ALTURA	18
D. INTERNO	
D. EXTERNO	
ROSCA	
BICOS	

**FAASB2**

LEXUS / TOYOTA / SUBARU



OEM:	
72880AG000	
EQUIVALÊNCIAS:	
MANN	CU2131
MAHLE	LA131
FRAM	CF9846
WEGA	AKX1964
TECFIL	
MEDIDAS (mm):	
COMPRIMENTO	216
LARGURA	212
ALTURA	17,2
D. INTERNO	
D. EXTERNO	
ROSCA	
BICOS	

**FAASB3**

SUBARU



OEM:	
72880FG000	
EQUIVALÊNCIAS:	
MANN	CU22004
MAHLE	LA461
FRAM	
WEGA	AKX2200
TECFIL	
MEDIDAS (mm):	
COMPRIMENTO	219
LARGURA	220
ALTURA	30/57,5
D. INTERNO	
D. EXTERNO	
ROSCA	
BICOS	

**FAASB5**

SUBARU



OEM:	
G3010SA100	
EQUIVALÊNCIAS:	
MANN	CU22003
MAHLE	LA452
FRAM	
WEGA	AKX2201
TECFIL	
MEDIDAS (mm):	
COMPRIMENTO	216
LARGURA	201
ALTURA	30/40
D. INTERNO	
D. EXTERNO	
ROSCA	
BICOS	

**FAASMO**

SMART



OEM:	
0001110V003	
EQUIVALÊNCIAS:	
MANN	CUK2032
MAHLE	LAK96
FRAM	CFA9445
WEGA	AKX3520/C
TECFIL	
MEDIDAS (mm):	
COMPRIMENTO	225
LARGURA	220
ALTURA	40
D. INTERNO	
D. EXTERNO	
ROSCA	
BICOS	

**FAASM2**

SMART



OEM:	
A4518300018	
EQUIVALÊNCIAS:	
MANN	CUK2132
MAHLE	LAK430
FRAM	CA10612
WEGA	AKX3568/C
TECFIL	
MEDIDAS (mm):	
COMPRIMENTO	215
LARGURA	214
ALTURA	26
D. INTERNO	
D. EXTERNO	
ROSCA	
BICOS	

**FAASS01**

SSANGYONG



OEM:	
6812008130	
EQUIVALÊNCIAS:	
MANN	
MAHLE	LA391/S
FRAM	
WEGA	AKX3584
TECFIL	
MEDIDAS (mm):	
COMPRIMENTO	290
LARGURA	101
ALTURA	20
D. INTERNO	
D. EXTERNO	
ROSCA	
BICOS	

**FAASS04**

SSANGYONG



OEM:	
68111091A0	
EQUIVALÊNCIAS:	
MANN	CU22009/2
MAHLE	LA392/S
FRAM	
WEGA	AKX3583
TECFIL	
MEDIDAS (mm):	
COMPRIMENTO	220
LARGURA	98
ALTURA	25
D. INTERNO	
D. EXTERNO	
ROSCA	
BICOS	



**SSANGYONG**

**FAASS05**



<b>OEM:</b>	
6811634000	
<b>EQUIVALÊNCIAS:</b>	
MANN	
MAHLE	
FRAM	
WEGA	AKX3600
TECFIL	
<b>MEDIDAS (mm):</b>	
COMPRIMENTO	226
LARGURA	220
ALTURA	20
D. INTERNO	
D. EXTERNO	
ROSCA	
BICOS	

**CHEVROLET / SUZUKI**

**FAASZ01**



<b>OEM:</b>	
9586081A00	
<b>EQUIVALÊNCIAS:</b>	
MANN	CU22002/2
MAHLE	LAK448
FRAM	
WEGA	AKX1970
TECFIL	ACP122
<b>MEDIDAS (mm):</b>	
COMPRIMENTO	220
LARGURA	114
ALTURA	18,5
D. INTERNO	
D. EXTERNO	
ROSCA	
BICOS	

**SUZUKI**

**FAASZ02**



<b>OEM:</b>	
9900005130	
<b>EQUIVALÊNCIAS:</b>	
MANN	
MAHLE	
FRAM	
WEGA	
TECFIL	
<b>MEDIDAS (mm):</b>	
COMPRIMENTO	255
LARGURA	209,2
ALTURA	31
D. INTERNO	
D. EXTERNO	
ROSCA	
BICOS	

**SUZUKI**

**FAASZ07**



<b>OEM:</b>	
9586164J00	
<b>EQUIVALÊNCIAS:</b>	
MANN	CU2138
MAHLE	LA408
FRAM	
WEGA	AKX1971
TECFIL	
<b>MEDIDAS (mm):</b>	
COMPRIMENTO	195
LARGURA	270
ALTURA	22
D. INTERNO	
D. EXTERNO	
ROSCA	
BICOS	

**SUZUKI**

**FAASZ08**



<b>OEM:</b>	
9586062J00	
<b>EQUIVALÊNCIAS:</b>	
MANN	CU1827
MAHLE	LA155
FRAM	CF10202
WEGA	AKX1953
TECFIL	
<b>MEDIDAS (mm):</b>	
COMPRIMENTO	185
LARGURA	176,5
ALTURA	29
D. INTERNO	
D. EXTERNO	
ROSCA	
BICOS	

**SUZUKI**

**FAASZ11**



<b>OEM:</b>	
9586080J00	
<b>EQUIVALÊNCIAS:</b>	
MANN	CU21004
MAHLE	LA682
FRAM	
WEGA	AKX1973
TECFIL	
<b>MEDIDAS (mm):</b>	
COMPRIMENTO	204
LARGURA	176
ALTURA	30
D. INTERNO	
D. EXTERNO	
ROSCA	
BICOS	

**TOYOTA**

**FAATY2**



<b>OEM:</b>	
8856852010	
<b>EQUIVALÊNCIAS:</b>	
MANN	CU1828
MAHLE	LA109
FRAM	CF9466
WEGA	AKX1962
TECFIL	ACP885
<b>MEDIDAS (mm):</b>	
COMPRIMENTO	213
LARGURA	197
ALTURA	18
D. INTERNO	
D. EXTERNO	
ROSCA	
BICOS	

**LEXUS**

**FAATY5**



<b>OEM:</b>	
8713948020	
<b>EQUIVALÊNCIAS:</b>	
MANN	MC1017
MAHLE	LA199
FRAM	CF10138
WEGA	AKX2160
TECFIL	
<b>MEDIDAS (mm):</b>	
COMPRIMENTO	235
LARGURA	215
ALTURA	19
D. INTERNO	
D. EXTERNO	
ROSCA	
BICOS	

**LEXUS / TOYOTA**

**FAATY8**



<b>OEM:</b>	
87139YZZ03	
<b>EQUIVALÊNCIAS:</b>	
MANN	CUK2226
MAHLE	LAK131
FRAM	CF10157
WEGA	AKX1966
TECFIL	
<b>MEDIDAS (mm):</b>	
COMPRIMENTO	220
LARGURA	212
ALTURA	15
D. INTERNO	
D. EXTERNO	
ROSCA	
BICOS	

**LEXUS / TOYOTA / SUBARU**

**FAATY9**



<b>OEM:</b>	
8713930040	
<b>EQUIVALÊNCIAS:</b>	
MANN	CU1919
MAHLE	LA395
FRAM	CF10285
WEGA	AKX1965
TECFIL	ACP887
<b>MEDIDAS (mm):</b>	
COMPRIMENTO	215
LARGURA	193
ALTURA	29
D. INTERNO	
D. EXTERNO	
ROSCA	
BICOS	